

ΕΛΛΗΝΙΚΗ ΔΗΜΟΚΡΑΤΙΑ  
ΠΕΡΙΦΕΡΕΙΑ ΚΡΗΤΗΣ  
ΔΗΜΟΣ ΧΑΝΙΩΝ

ΠΡΑΞΗ ΕΦΑΡΜΟΓΗΣ ΣΧΕΔΙΟΥ ΠΟΛΕΩΣ  
ΠΑΡΗΓΟΡΙΑ Δ.Ε. ΝΕΑΣ ΚΥΔΩΝΙΑΣ  
ΔΗΜΟΥ ΧΑΝΙΩΝ

Π Ρ Α Ξ Η Ε Φ Α Ρ Μ Ο Γ Η Σ

ΠΙΝΑΚΑΣ ΣΥΝΤΕΤΑΓΜΕΝΩΝ ΤΕΛΙΚΩΝ ΙΔΙΟΚΤΗΣΙΩΝ ΑΝΑ Ο.Τ.  
(ΣΕΛΙΔΕΣ 1-201, Ο.Τ. 1042 - Ο.Τ. 1463)

ΑΝΑΔΟΧΟΙ ΜΕΛΕΤΗΣ  
ΝΙΚΟΛΑΟΣ ΚΑΛΟΓΕΡΗΣ  
ΓΕΩΡΓΙΟΣ ΒΕΡΥΚΑΚΗΣ  
ΙΩΑΝΝΑ ΜΕΛΑΚΗ  
ΙΩΑΝΝΗΣ ΣΧΙΝΑΣ  
ΑΙΚΑΤΕΡΙΝΗ ΠΑΥΛΑΚΗ  
ΘΕΟΔΩΡΟΣ ΠΑΠΑΘΑΝΑΣΙΟΥ

ΓΙΑ ΤΟΝ ΑΝΑΔΟΧΟ ΤΗΣ ΜΕΛΕΤΗΣ:

ΓΕΩΡΓΙΟΣ ΒΕΡΥΚΑΚΗΣ

ΣΥΝΤΑΞΗ ΜΕΛΕΤΗΣ

**Ν. ΚΑΛΟΓΕΡΗΣ - Γ. ΒΕΡΥΚΑΚΗΣ**  
**ΑΓΡ. ΤΟΠΟΓΡΑΦΟΙ ΜΗΧΑΝΙΚΟΙ**  
ΣΤΡ. ΤΖΑΝΑΚΑΚΗ 56 ΧΑΝΙΑ  
Τηλ. : 28210 44510

Δ	ΔΕΚΕΜΒΡΙΟΣ 2022	Γ. ΒΕΡΥΚΑΚΗΣ ΤΟΠ. ΜΗΧ.	
Γ	ΣΕΠΤΕΜΒΡΙΟΣ 2022	Γ. ΒΕΡΥΚΑΚΗΣ ΤΟΠ. ΜΗΧ.	
Β	ΙΟΥΝΙΟΣ 2021	Γ. ΒΕΡΥΚΑΚΗΣ ΤΟΠ. ΜΗΧ.	
Α	ΑΠΡΙΛΙΟΣ 2017	Γ. ΒΕΡΥΚΑΚΗΣ ΤΟΠ. ΜΗΧ.	
ΕΚΔΟΣΗ	ΗΜΕΡΟΜΗΝΙΑ	ΟΝΟΜΑΤΕΠΩΝΥΜΟ	ΥΠΟΓΡΑΦΗ

ΥΠΗΡΕΣΙΑ	ΕΝΕΡΓΕΙΑ		ΟΝΟΜΑΤΕΠΩΝΥΜΟ	ΗΜΕΡΟΜΗΝΙΑ	ΥΠΟΓΡΑΦΗ
ΔΗΜΟΣ ΧΑΝΙΩΝ ΔΙΕΥΘΥΝΣΗ ΥΠΗΡΕΣΙΑΣ ΔΟΜΗΣΗΣ ΤΜΗΜΑ ΠΟΛΕΟΔΟΜΙΚΩΝ ΕΦΑΡΜΟΓΩΝ	ΕΛΕΓΧΘΗΚΕ	Η ΕΠΙΒΛΕΠΟΥΣΑ	ΙΟΥΛΙΑ ΜΑΝΩΛΙΚΑΚΗ ΤΟΠ. ΜΗΧ.		
	ΘΕΩΡΗΘΗΚΕ	Η ΑΝΑΠΛΗΡΩΤΡΙΑ ΠΡΟΪΣΤΑΜΕΝΗ	ΧΡΙΣΤΙΝΗ ΑΠΟΣΤΟΛΟΠΟΥΛΟΥ ΠΟΛ. ΜΗΧ.		
	ΕΓΚΡΙΘΗΚΕ	Ο ΑΝΑΠΛΗΡΩΤΗΣ ΔΙΕΥΘΥΝΤΗΣ	ΦΡΑΓΚΙΣΚΟΣ ΤΡΟΥΛΛΑΚΗΣ ΠΟΛ. ΜΗΧ.		
ΑΠΟΦΑΣΗ ΕΓΚΡΙΣΗΣ					

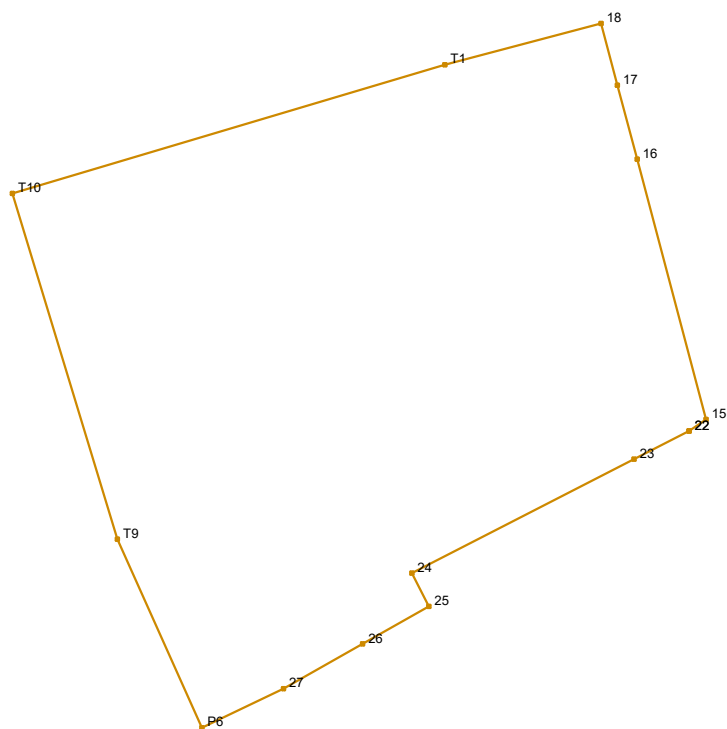

Νέα ιδιοκτησία εντός ΟΤ							
id1:1042		id2:01		Σημεία:14		Εμβαδό:895.35 m <sup>2</sup>	
Σημείο	X	Y	μήκος	Σημείο	X	Y	μήκος
22	499803.188	3928963.616	3.41	T10	499765.870	3928976.710	24.88
23	499800.158	3928962.061	13.78	T1	499789.714	3928983.811	8.92
24	499787.898	3928955.769	2.06	18	499798.335	3928986.100	3.53
25	499788.841	3928953.932	4.19	17	499799.243	3928982.684	4.22
26	499785.191	3928951.871	5.02	16	499800.325	3928978.609	14.85
27	499780.818	3928949.402	4.98	15	499804.137	3928964.252	1.14
P6	499776.326	3928947.249	11.41	22	499803.188	3928963.616	
T9	499771.658	3928957.656	19.91				

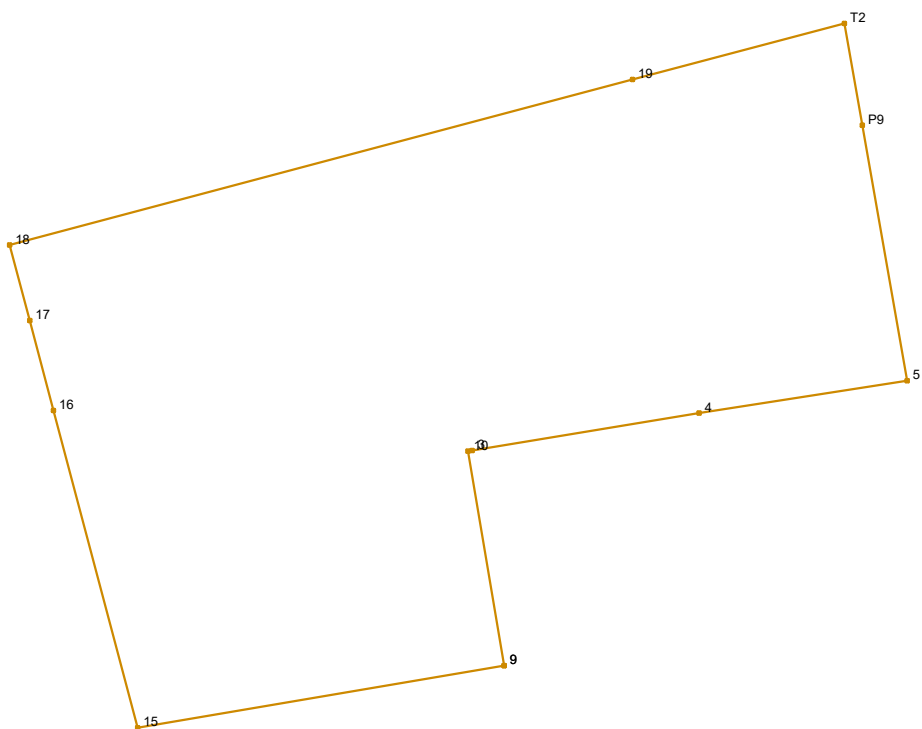

Νέα ιδιοκτησία εντός ΟΤ							
id1:1042		id2:02		Σημεία:12		Εμβαδό:727.56 m <sup>2</sup>	
Σημείο	X	Y	μήκος	Σημείο	X	Y	μήκος
9	499820.720	3928967.059	16.82	P9	499836.929	3928991.525	11.74
15	499804.137	3928964.252	14.85	5	499838.956	3928979.960	9.53
16	499800.325	3928978.609	4.22	4	499829.541	3928978.490	10.40
17	499799.243	3928982.684	3.53	3	499819.278	3928976.801	0.20
18	499798.335	3928986.100	29.18	10	499819.077	3928976.768	9.85
19	499826.535	3928993.589	9.92	9	499820.720	3928967.059	
T2	499836.121	3928996.134	4.68				

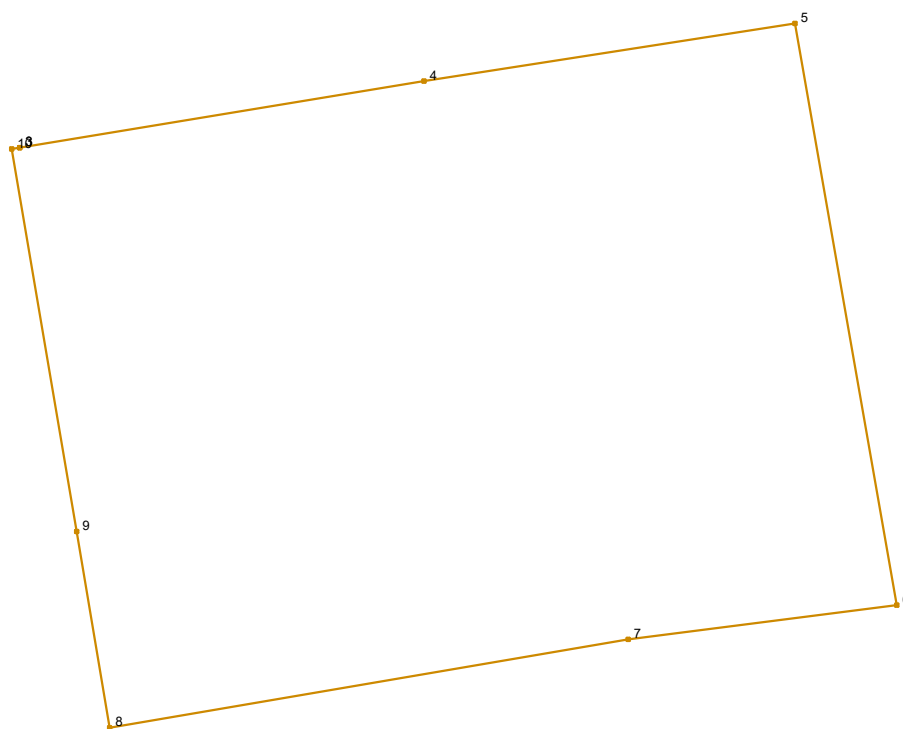

Νέα ιδιοκτησία εντός ΟΤ							
id1:1042		id2:03		Σημεία:8		Εμβαδό:300.00 m <sup>2</sup>	
Σημείο	X	Y	μήκος	Σημείο	X	Y	μήκος
3	499819.278	3928976.801	10.40	8	499821.563	3928962.079	5.05
4	499829.541	3928978.490		9.53	9	499820.720	
5	499838.956	3928979.960	14.99	10	499819.077	3928976.768	0.20
6	499841.544	3928965.194	6.87	3	499819.278	3928976.801	
7	499834.727	3928964.324	13.35				

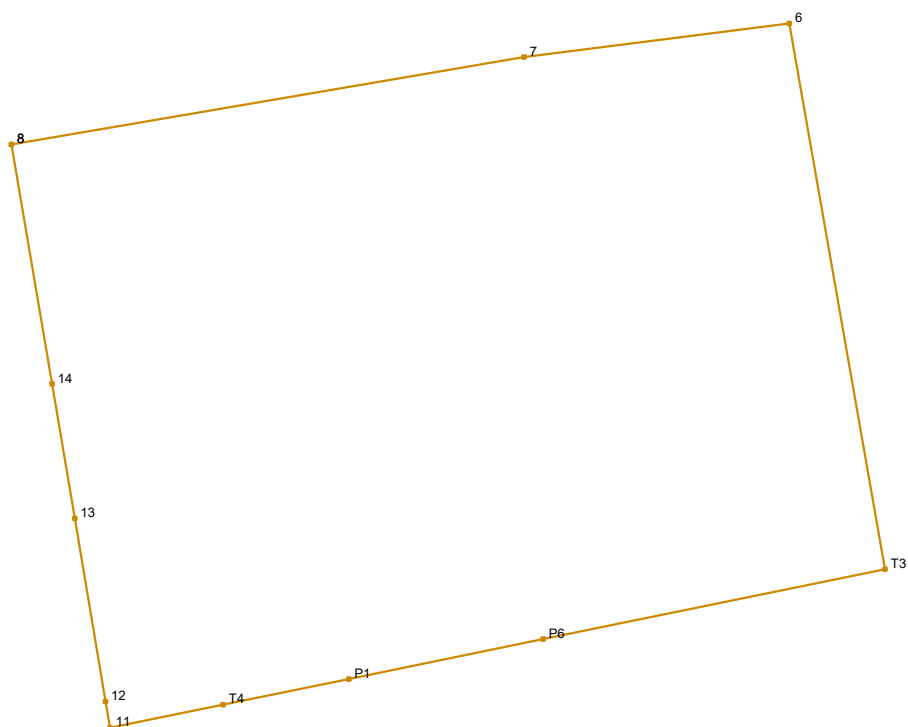

Νέα ιδιοκτησία εντός ΟΤ							
id1:1042		id2:04		Σημεία:11		Εμβαδό:300.00 m <sup>2</sup>	
Σημείο	X	Y	μήκος	Σημείο	X	Y	μήκος
8	499821.563	3928962.079	13.35	T4	499826.995	3928947.697	2.96
7	499834.727	3928964.324		11	499824.096	3928947.103	0.68
6	499841.544	3928965.194	6.87	12	499823.982	3928947.779	4.77
T3	499844.000	3928951.176	14.23	13	499823.186	3928952.480	3.51
P6	499835.221	3928949.379	8.96	14	499822.602	3928955.937	6.23
P1	499830.223	3928948.357	5.10	8	499821.563	3928962.079	3.29
			3.29				

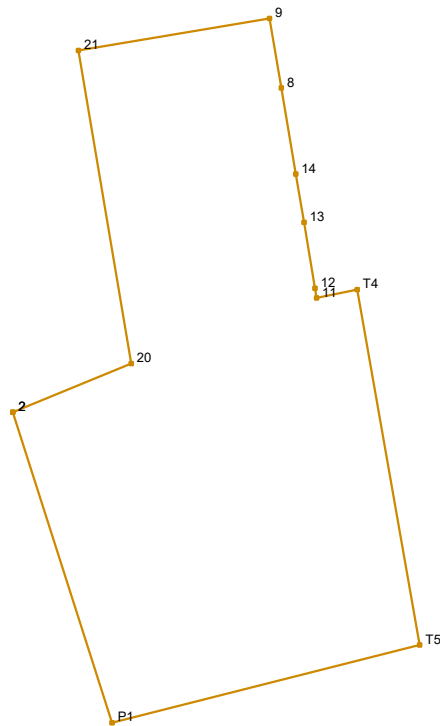

Νέα ιδιοκτησία εντός ΟΤ							
id1:1042		id2:05		Σημεία:12		Εμβαδό:900.19 m <sup>2</sup>	
Σημείο	X	Y	μήκος	Σημείο	X	Y	μήκος
2	499802.397	3928938.932	9.15	12	499823.982	3928947.779	0.68
20	499810.861	3928942.401	22.67	11	499824.096	3928947.103	2.96
21	499807.080	3928964.751	13.83	T4	499826.995	3928947.697	25.77
9	499820.720	3928967.059	5.05	T5	499831.459	3928922.314	22.66
8	499821.563	3928962.079	6.23	P1	499809.493	3928916.762	23.28
14	499822.602	3928955.937	3.51	2	499802.397	3928938.932	
13	499823.186	3928952.480	4.77				

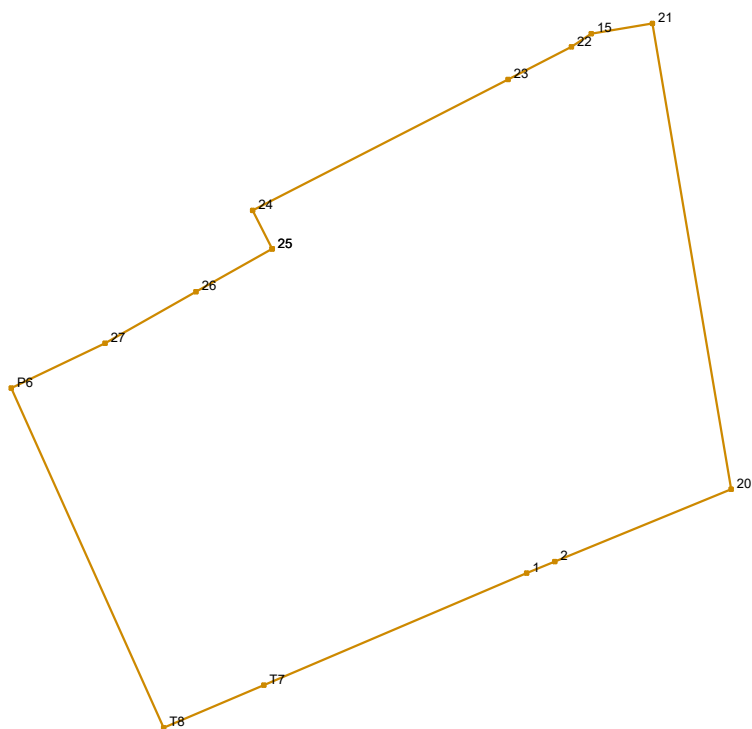

Νέα ιδιοκτησία εντός ΟΤ							
id1:1042		id2:06		Σημεία:14		Εμβαδό:659.73 m <sup>2</sup>	
Σημείο	X	Y	μήκος	Σημείο	X	Y	μήκος
25	499788.841	3928953.932	2.06	1	499801.038	3928938.375	13.69
24	499787.898	3928955.769	13.78	T7	499788.441	3928933.015	5.23
23	499800.158	3928962.061	3.41	T8	499783.628	3928930.967	17.84
22	499803.188	3928963.616	1.14	P6	499776.326	3928947.249	4.98
15	499804.137	3928964.252	2.98	27	499780.818	3928949.402	5.02
21	499807.080	3928964.751	22.67	26	499785.191	3928951.871	4.19
20	499810.861	3928942.401	9.15	25	499788.841	3928953.932	
2	499802.397	3928938.932	1.47				

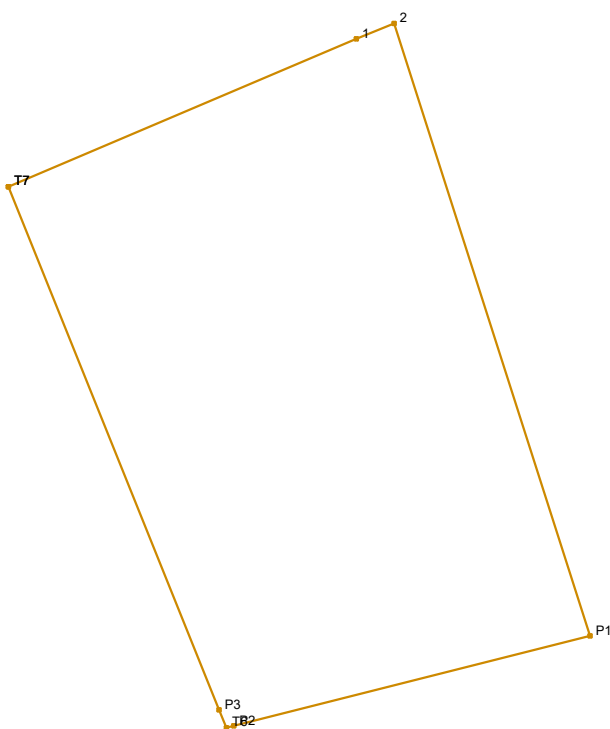

Νέα ιδιοκτησία εντός ΟΤ							
id1:1042		id2:07		Σημεία:7		Εμβαδό:317.87 m <sup>2</sup>	
Σημείο	X	Y	μήκος	Σημείο	X	Y	μήκος
T7	499788.441	3928933.015	13.69	P2	499796.599	3928913.503	0.28
1	499801.038	3928938.375		1.47	T6	499796.326	3928913.434
2	499802.397	3928938.932	23.28	P3	499796.063	3928914.088	20.40
P1	499809.493	3928916.762	13.30	T7	499788.441	3928933.015	



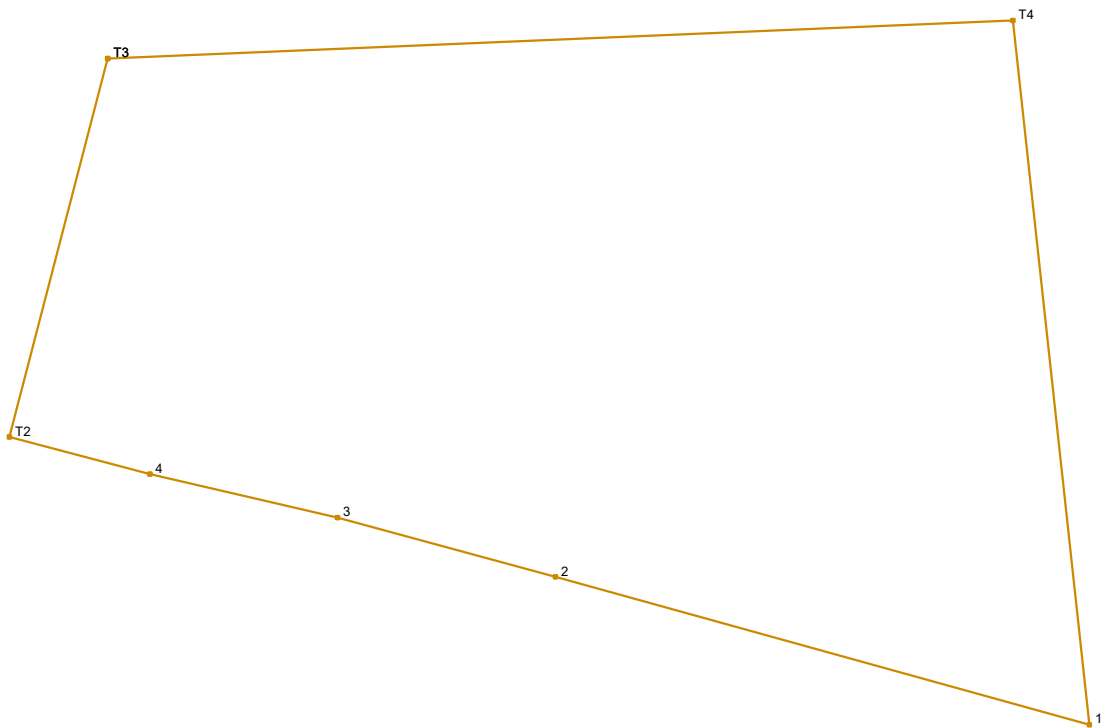

Νέα ιδιοκτησία εντός ΟΤ							
id1:1421		id2:01		Σημεία:7		Εμβαδό:1282.22 m <sup>2</sup>	
Σημείο	X	Y	μήκος	Σημείο	X	Y	μήκος
T3	500109.647	3929072.160		3	500120.904	3929049.695	
T4	500153.964	3929074.037	44.36	4	500111.720	3929051.830	9.43
1	500157.700	3929039.560	34.68	T2	500104.833	3929053.642	7.12
2	500131.570	3929046.800	27.11	T3	500109.647	3929072.160	19.13
			11.05				

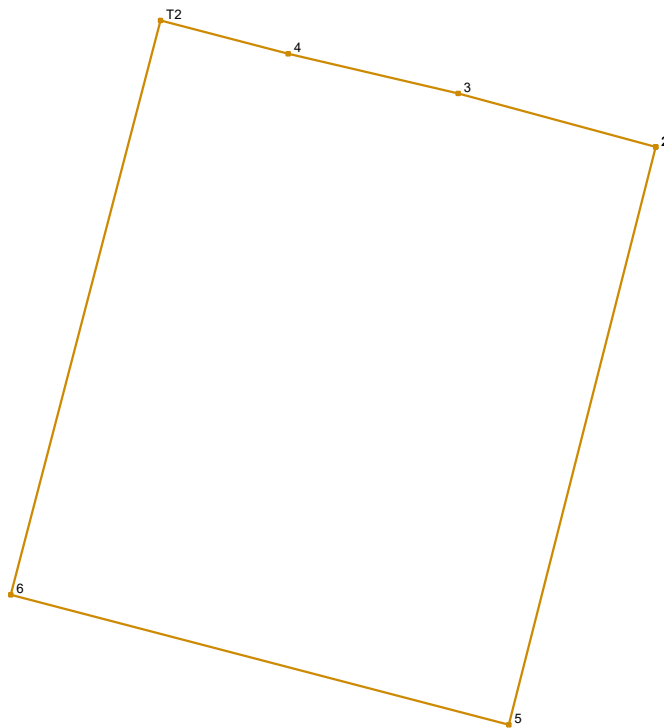

Νέα ιδιοκτησία εντός ΟΤ							
id1:1421		id2:02		Σημεία:6		Εμβαδό:890.73 m <sup>2</sup>	
Σημείο	X	Y	μήκος	Σημείο	X	Y	μήκος
2	500131.570	3929046.800	32.18	4	500111.720	3929051.830	9.43
5	500123.635	3929015.612		27.79	3	500120.904	
6	500096.743	3929022.626	32.05	2	500131.570	3929046.800	
T2	500104.833	3929053.642	7.12				

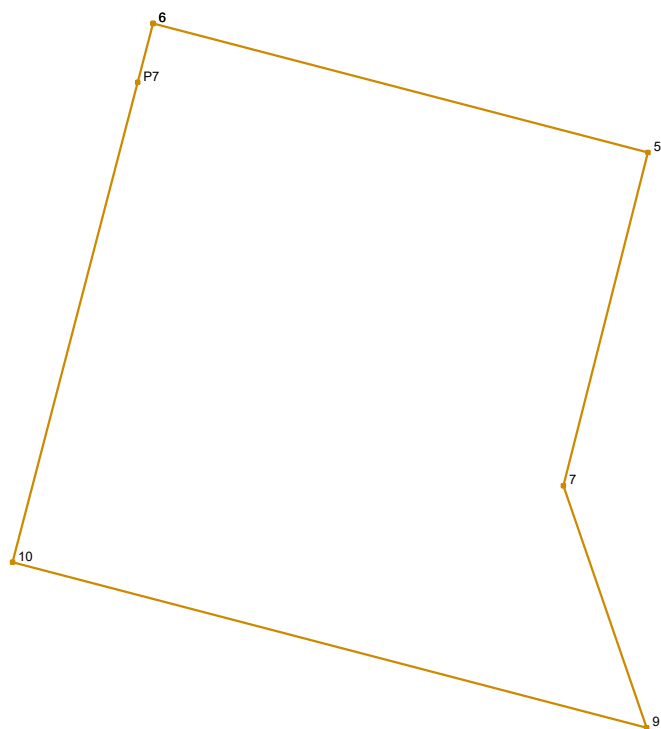

Νέα ιδιοκτησία εντός ΟΤ							
id1:1421		id2:03N		Σημεία:6		Εμβαδό:887.99 m <sup>2</sup>	
Σημείο	X	Y	μήκος	Σημείο	X	Y	μήκος
6	500096.743	3929022.626	27.79	10	500089.106	3928993.343	26.95
5	500123.635	3929015.612		18.68	P7	500095.907	
7	500119.029	3928997.510	13.91	6	500096.743	3929022.626	
9	500123.558	3928984.358	35.60				

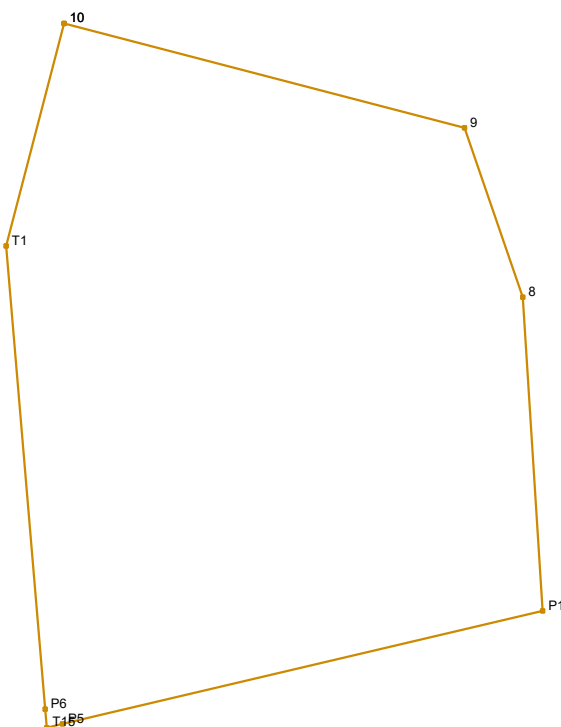

Νέα ιδιοκτησία εντός ΟΤ							
id1:1421		id2:04		Σημεία:8		Εμβαδό:2164.74 m <sup>2</sup>	
Σημείο	X	Y	μήκος	Σημείο	X	Y	μήκος
10	500089.106	3928993.343	35.60	T15	500087.602	3928932.719	1.60
9	500123.558	3928984.358	15.43	P6	500087.467	3928934.317	40.00
8	500128.582	3928969.767	27.05	T1	500084.107	3928974.176	19.81
P1	500130.281	3928942.774	42.44	10	500089.106	3928993.343	
P5	500088.971	3928933.042	1.41				

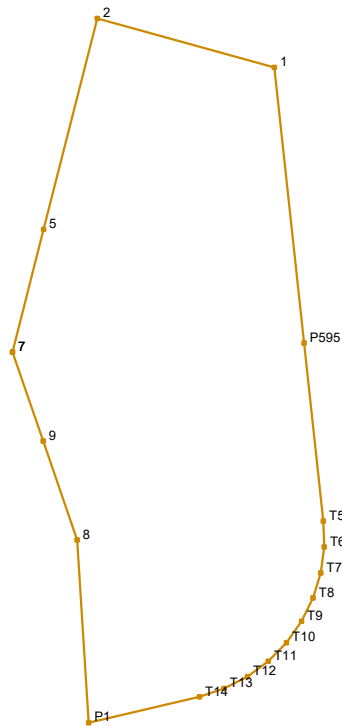

Νέα ιδιοκτησία εντός ΟΤ							
ιδ1:1421		ιδ2:05		Σημεία:18		Εμβαδό:3454.37 m <sup>2</sup>	
Σημείο	X	Y	μήκος	Σημείο	X	Y	μήκος
7	500119.029	3928997.510	18.68	T10	500159.524	3928954.600	3.85
5	500123.635	3929015.612	32.18	T11	500156.825	3928951.851	3.85
2	500131.570	3929046.800	27.11	T12	500153.722	3928949.568	3.85
1	500157.700	3929039.560	40.95	T13	500150.293	3928947.811	3.85
P595	500162.112	3928998.845	26.43	T14	500146.628	3928946.625	16.79
T5	500164.959	3928972.565	3.85	P1	500130.281	3928942.774	27.05
T6	500165.065	3928968.714	3.85	8	500128.582	3928969.767	15.43
T7	500164.554	3928964.896	3.85	9	500123.558	3928984.358	13.91
T8	500163.438	3928961.208	3.85	7	500119.029	3928997.510	
T9	500161.747	3928957.747	3.85				

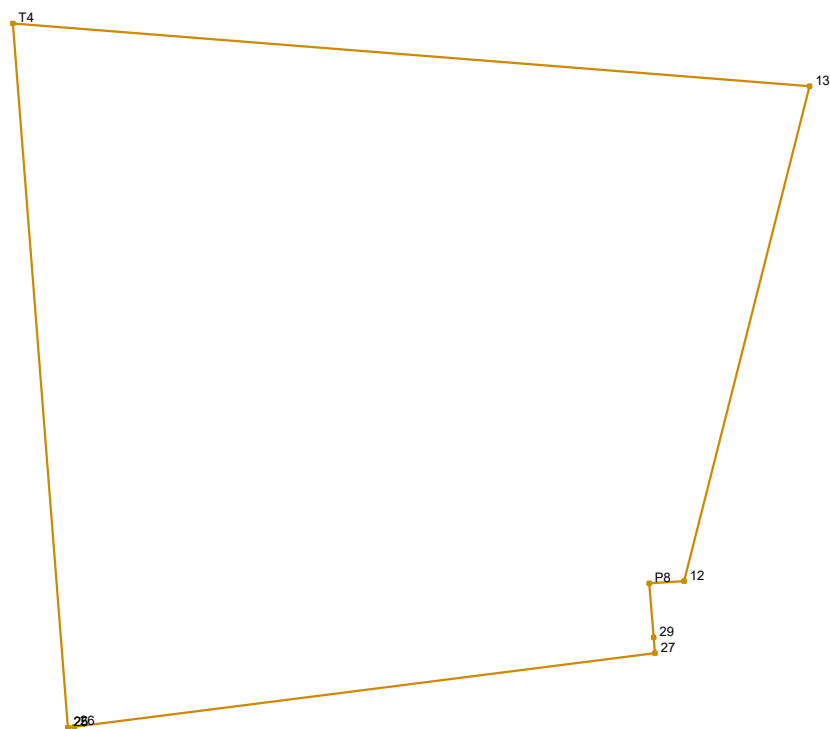

Νέα ιδιοκτησία εντός ΟΤ							
id1:1424		id2:01N		Σημεία:8		Εμβαδό:501.00 m <sup>2</sup>	
Σημείο	X	Y	μήκος	Σημείο	X	Y	μήκος
25	499991.232	3928975.328		29	500010.973	3928978.375	
			23.82				0.53
T4	499989.375	3928999.072		27	500011.016	3928977.848	
			26.94				19.73
13	500016.233	3928996.949		26	499991.443	3928975.355	
			17.21				0.21
12	500012.003	3928980.268		25	499991.232	3928975.328	
			1.18				
P8	500010.822	3928980.191					
			1.82				

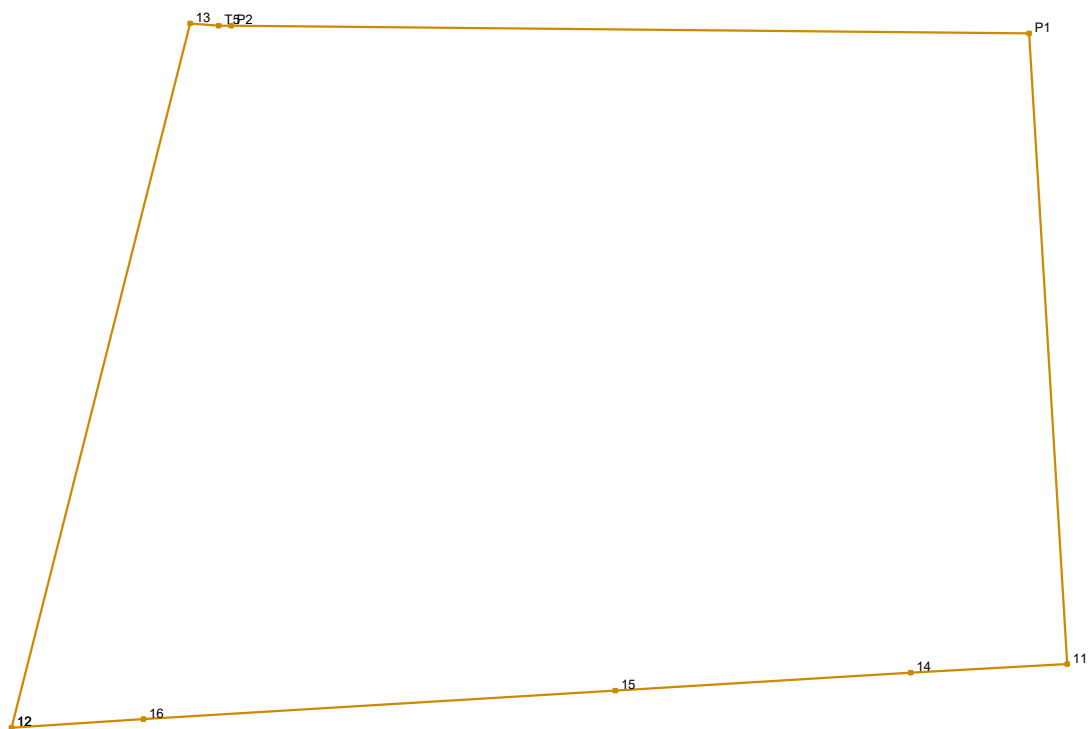

Νέα ιδιοκτησία εντός ΟΤ							
id1:1424		id2:02		Σημεία:9		Εμβαδό:352.77 m <sup>2</sup>	
Σημείο	X	Y	μήκος	Σημείο	X	Y	μήκος
12	500012.003	3928980.268	17.21	11	500037.003	3928981.779	3.71
13	500016.233	3928996.949		0.68	14	500033.298	3928981.575
T5	500016.912	3928996.896	0.29	15	500026.304	3928981.150	11.20
P2	500017.205	3928996.893	18.90	16	500015.126	3928980.472	3.13
P1	500036.107	3928996.711	14.96	12	500012.003	3928980.268	

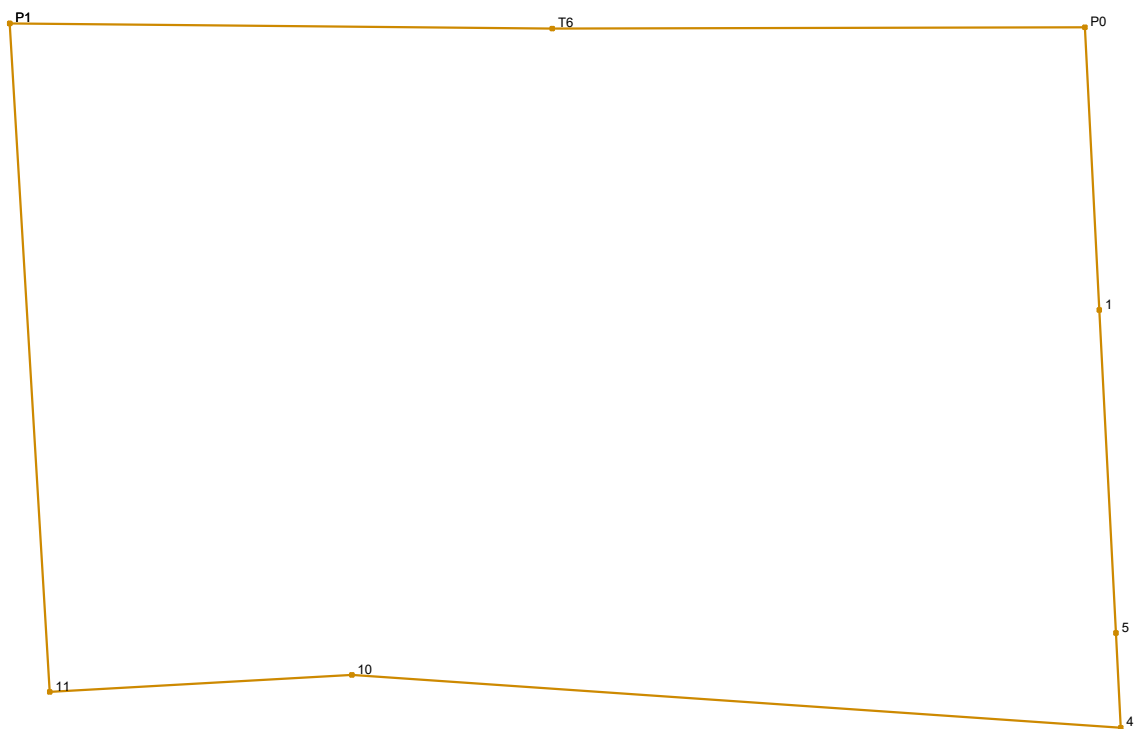

Νέα ιδιοκτησία εντός ΟΤ							
id1:1424		id2:03		Σημεία:8		Εμβαδό:358.10 m <sup>2</sup>	
Σημείο	X	Y	μήκος	Σημείο	X	Y	μήκος
P1	500036.107	3928996.711	12.12	4	500060.930	3928980.975	17.22
T6	500048.227	3928996.594		10	500043.748	3928982.151	6.75
P0	500060.124	3928996.620	6.32	11	500037.003	3928981.779	14.96
1	500060.449	3928990.305		P1	500036.107	3928996.711	
5	500060.821	3928983.093	7.22				
			2.12				



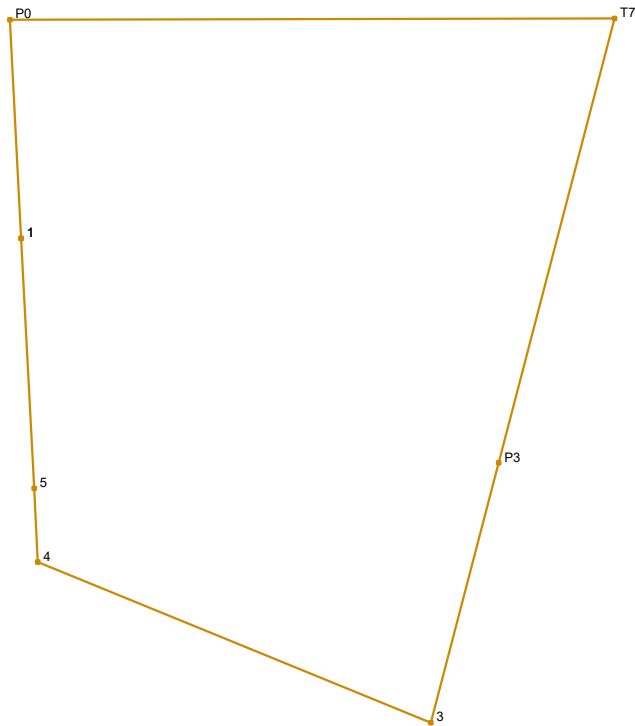

Νέα ιδιοκτησία εντός ΟΤ							
id1:1424		id2:04		Σημεία:7		Εμβαδό:263.97 m <sup>2</sup>	
Σημείο	X	Y	μήκος	Σημείο	X	Y	μήκος
1	500060.449	3928990.305	6.32	3	500072.269	3928976.337	12.25
P0	500060.124	3928996.620	17.44	4	500060.930	3928980.975	2.12
T7	500077.569	3928996.657	13.25	5	500060.821	3928983.093	7.22
P3	500074.224	3928983.832	7.75	1	500060.449	3928990.305	

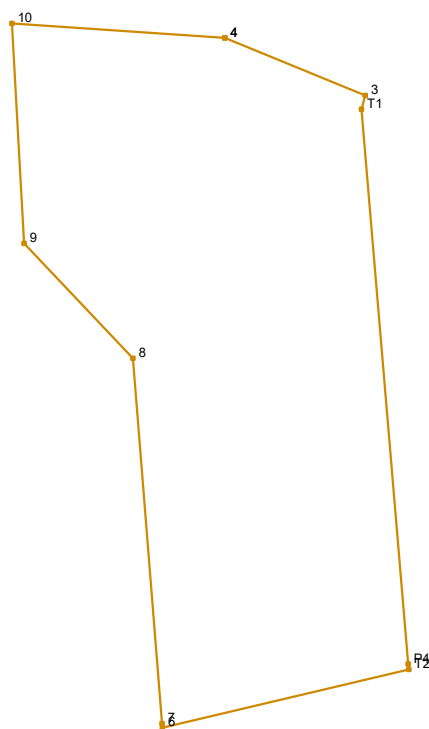

Νέα ιδιοκτησία εντός ΟΤ							
id1:1424		id2:05		Σημεία:10		Εμβαδό:1228.93 m <sup>2</sup>	
Σημείο	X	Y	μήκος	Σημείο	X	Y	μήκος
4	500060.930	3928980.975	12.25	7	500055.876	3928925.629	29.58
3	500072.269	3928976.337	1.16	8	500053.514	3928955.120	12.78
T1	500071.977	3928975.216	44.94	9	500044.727	3928964.399	17.78
P4	500075.751	3928930.437	0.43	10	500043.748	3928982.151	17.22
T2	500075.788	3928930.004	20.43	4	500060.930	3928980.975	
6	500055.903	3928925.298	0.33				

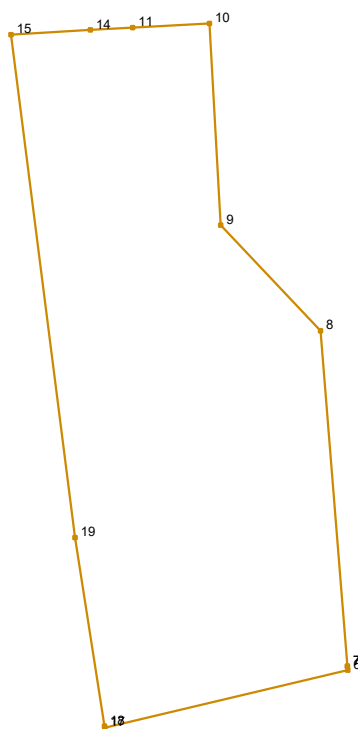

Νέα ιδιοκτησία εντός ΟΤ							
id1:1424		id2:06		Σημεία:11		Εμβαδό:1223.61 m <sup>2</sup>	
Σημείο	X	Y	μήκος	Σημείο	X	Y	μήκος
7	500055.876	3928925.629		14	500033.298	3928981.575	
			0.33				3.71
6	500055.903	3928925.298		11	500037.003	3928981.779	
			21.95				6.75
17	500034.542	3928920.242		10	500043.748	3928982.151	
			0.15				17.78
18	500034.520	3928920.387		9	500044.727	3928964.399	
			16.75				12.78
19	500031.948	3928936.940		8	500053.514	3928955.120	
			44.57				29.58
15	500026.304	3928981.150		7	500055.876	3928925.629	
			7.01				

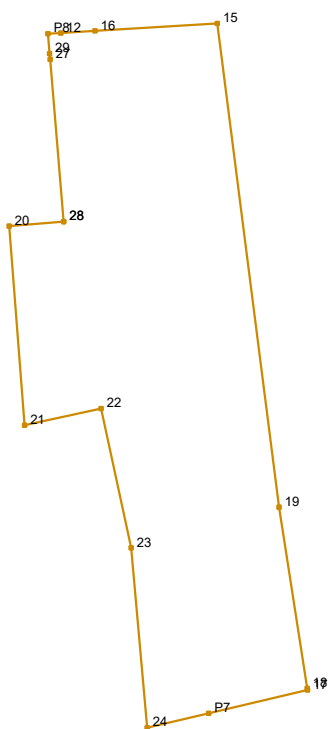

Νέα ιδιοκτησία εντός ΟΤ							
id1:1424		id2:07N		Σημεία:16		Εμβαδό:1058.72 m <sup>2</sup>	
Σημείο	X	Y	μήκος	Σημείο	X	Y	μήκος
28	500012.243	3928963.028	14.87	17	500034.542	3928920.242	9.29
27	500011.016	3928977.848	0.53	P7	500025.498	3928918.101	5.76
29	500010.973	3928978.375	1.82	24	500019.897	3928916.775	16.51
P8	500010.822	3928980.191	1.18	23	500018.430	3928933.215	13.02
12	500012.003	3928980.268	3.13	22	500015.675	3928945.938	7.14
16	500015.126	3928980.472	11.20	21	500008.694	3928944.427	18.25
15	500026.304	3928981.150	44.57	20	500007.271	3928962.617	4.99
19	500031.948	3928936.940	16.75	28	500012.243	3928963.028	
18	500034.520	3928920.387	0.15				

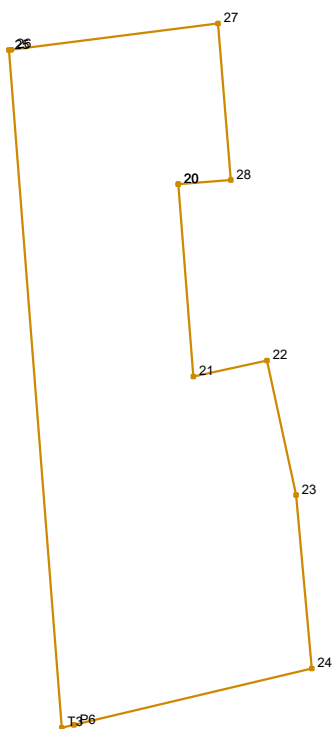

Νέα ιδιοκτησία εντός ΟΤ							
id1:1424		id2:08		Σημεία:11		Εμβαδό:1279.11 m <sup>2</sup>	
Σημείο	X	Y	μήκος	Σημείο	X	Y	μήκος
20	500007.271	3928962.617	18.25	T3	499996.248	3928911.177	64.35
21	500008.694	3928944.427	7.14	25	499991.232	3928975.328	0.21
22	500015.675	3928945.938	13.02	26	499991.443	3928975.355	19.73
23	500018.430	3928933.215	16.51	27	500011.016	3928977.848	14.87
24	500019.897	3928916.775	23.12	28	500012.243	3928963.028	4.99
P6	499997.394	3928911.449	1.18	20	500007.271	3928962.617	

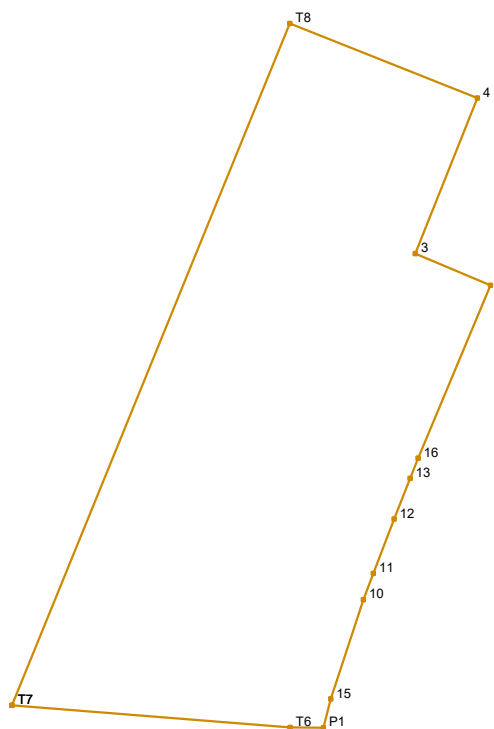

Νέα ιδιοκτησία εντός ΟΤ							
id1:1425		id2:01		Σημεία:13		Εμβαδό:1345.99 m <sup>2</sup>	
Σημείο	X	Y	μήκος	Σημείο	X	Y	μήκος
T7	499993.542	3929008.774		12	500026.244	3929024.734	
			63.02				4.99
T8	500017.313	3929067.142		11	500024.471	3929020.072	
			17.28				2.42
4	500033.365	3929060.749		10	500023.611	3929017.811	
			14.33				8.93
3	500028.063	3929047.439		15	500020.830	3929009.324	
			6.99				2.54
2	500034.505	3929044.721		P1	500020.191	3929006.864	
			16.05				2.85
16	500028.289	3929029.920		T6	500017.346	3929006.892	
			1.83				23.88
13	500027.617	3929028.214		T7	499993.542	3929008.774	
			3.74				

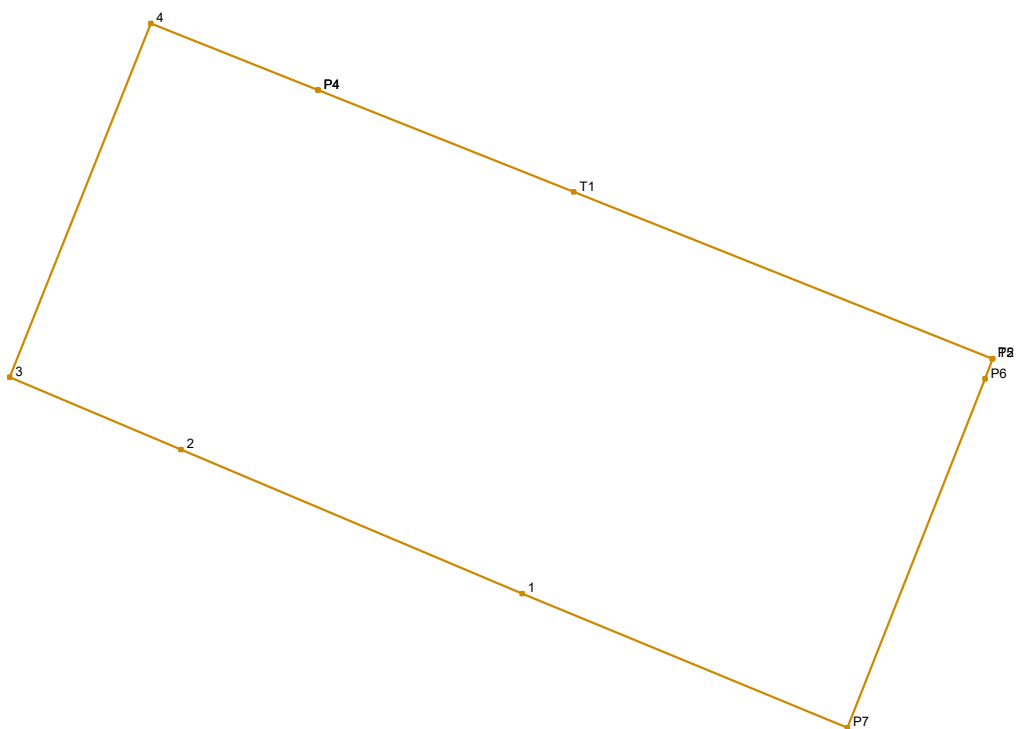

Νέα ιδιοκτησία εντός ΟΤ							
id1:1425		id2:02		Σημεία:10		Εμβαδό:500.00 m <sup>2</sup>	
Σημείο	X	Y	μήκος	Σημείο	X	Y	μήκος
P4	500039.654	3929058.243		1	500047.341	3929039.303	13.93
T1	500049.273	3929054.412	10.35	2	500034.505	3929044.721	6.99
P5	500065.013	3929048.142	16.94	3	500028.063	3929047.439	14.33
T2	500065.040	3929048.131	0.03	4	500033.365	3929060.749	6.77
P6	500064.744	3929047.380	0.81	P4	500039.654	3929058.243	
P7	500059.573	3929034.254	14.11				
			13.23				

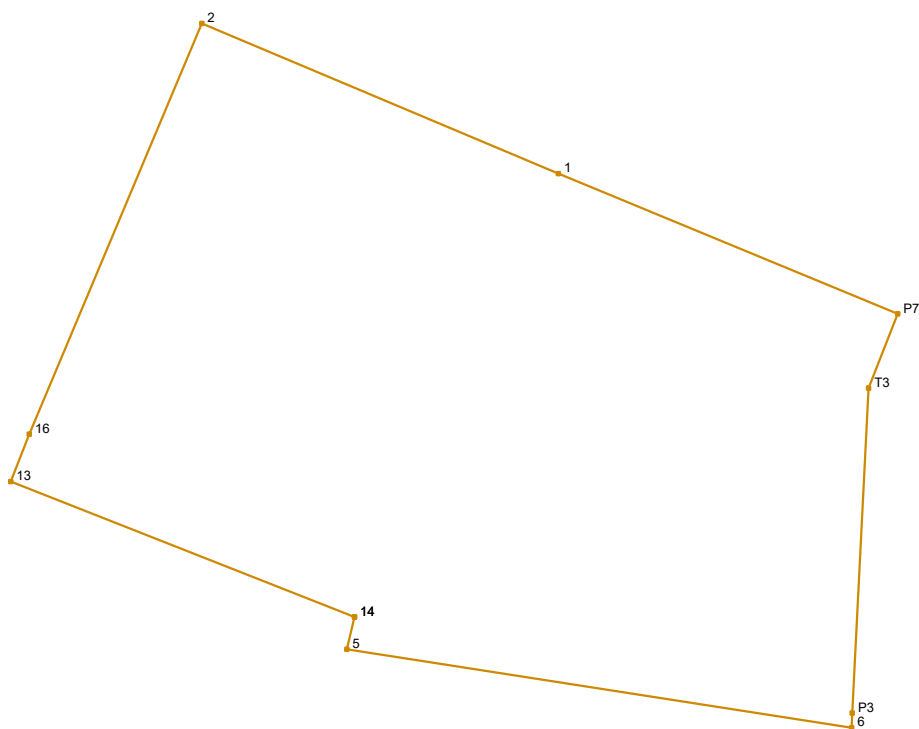

Νέα ιδιοκτησία εντός ΟΤ							
id1:1425		id2:03		Σημεία:10		Εμβαδό:500.00 m <sup>2</sup>	
Σημείο	X	Y	μήκος	Σημείο	X	Y	μήκος
14	500039.998	3929023.336	13.31	T3	500058.521	3929031.582	11.72
13	500027.617	3929028.214		P3	500057.932	3929019.873	
16	500028.289	3929029.920	1.83	6	500057.906	3929019.347	18.40
2	500034.505	3929044.721	16.05	5	500039.724	3929022.176	
1	500047.341	3929039.303	13.93	14	500039.998	3929023.336	
P7	500059.573	3929034.254	13.23				
			2.87				



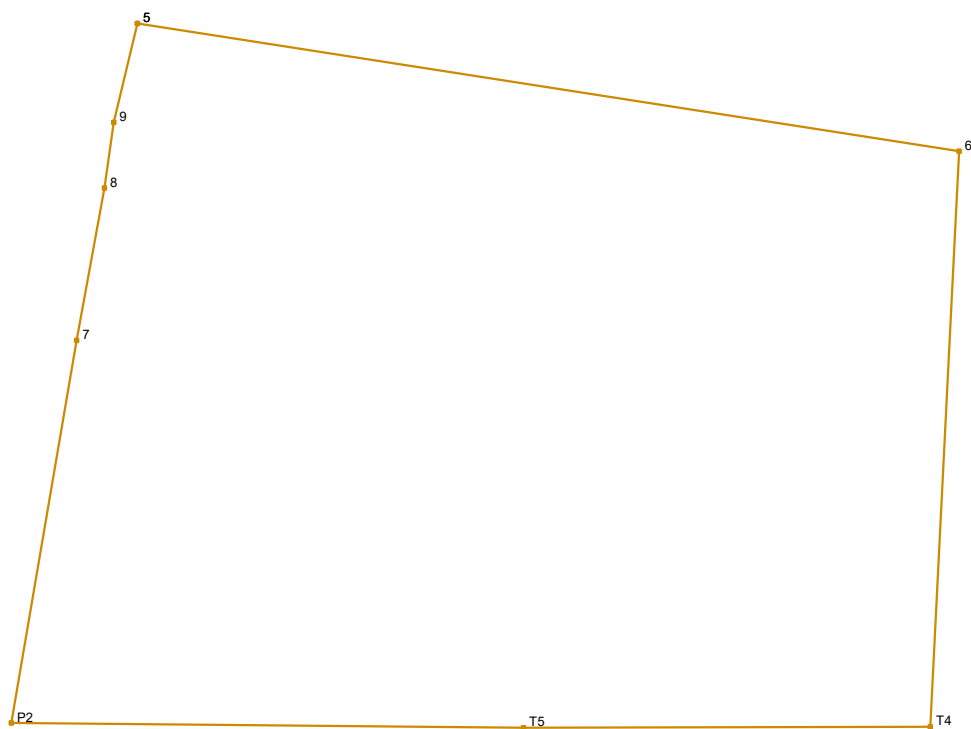

Νέα ιδιοκτησία εντός ΟΤ							
id1:1425		id2:04		Σημεία:8		Εμβαδό:275.49 m <sup>2</sup>	
Σημείο	X	Y	μήκος	Σημείο	X	Y	μήκος
5	500039.724	3929022.176	18.40	7	500038.384	3929015.160	3.43
6	500057.906	3929019.347		12.75	8	500039.000	3929018.536
T4	500057.266	3929006.614	9.00	9	500039.207	3929019.984	2.25
T5	500048.265	3929006.594	11.33	5	500039.724	3929022.176	
P2	500036.940	3929006.703	8.58				

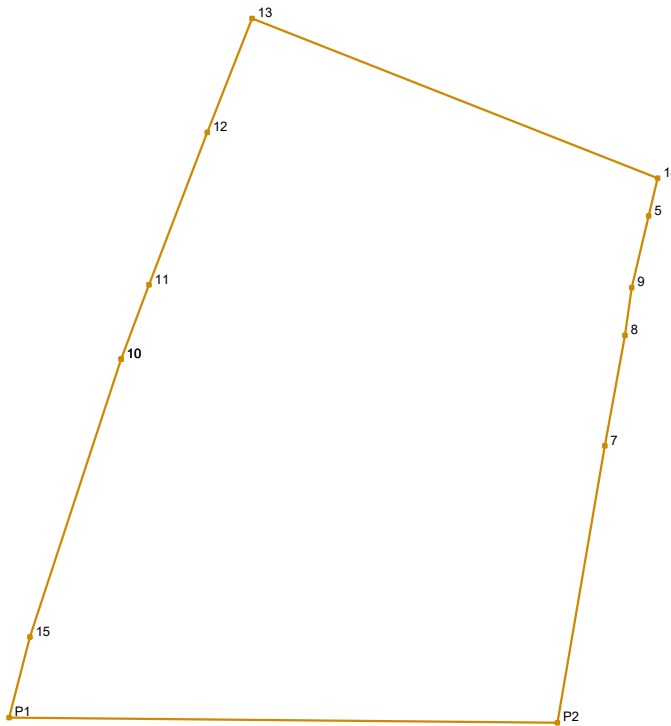

Νέα ιδιοκτησία εντός ΟΤ							
id1:1425		id2:05		Σημεία:12		Εμβαδό:293.48 m <sup>2</sup>	
Σημείο	X	Y	μήκος	Σημείο	X	Y	μήκος
10	500023.611	3929017.811		8	500039.000	3929018.536	
			2.42				3.43
11	500024.471	3929020.072		7	500038.384	3929015.160	
			4.99				8.58
12	500026.244	3929024.734		P2	500036.940	3929006.703	
			3.74				16.75
13	500027.617	3929028.214		P1	500020.191	3929006.864	
			13.31				2.54
14	500039.998	3929023.336		15	500020.830	3929009.324	
			1.19				8.93
5	500039.724	3929022.176		10	500023.611	3929017.811	
			2.25				
9	500039.207	3929019.984					
			1.46				

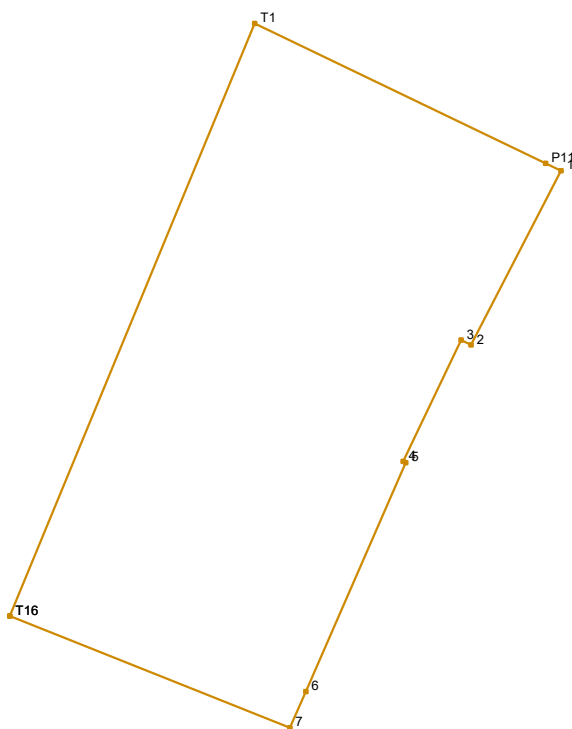

Νέα ιδιοκτησία εντός ΟΤ							
id1:1426		id2:01		Σημεία:10		Εμβαδό:935.85 m <sup>2</sup>	
Σημείο	X	Y	μήκος	Σημείο	X	Y	μήκος
T16	500019.590	3929072.694		4	500046.661	3929083.335	
			44.11				0.20
T1	500036.426	3929113.465		5	500046.834	3929083.241	
			22.22				17.18
P11	500056.448	3929103.826		6	500039.950	3929067.502	
			1.17				2.71
1	500057.499	3929103.320		7	500038.864	3929065.017	
			13.46				20.75
2	500051.328	3929091.354		T16	500019.590	3929072.694	
			0.77				
3	500050.630	3929091.686					
			9.25				

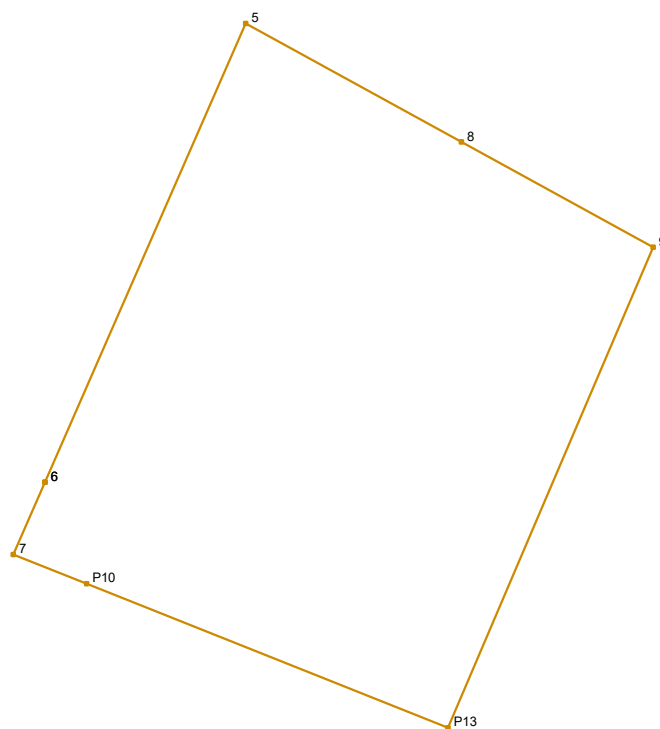

Νέα ιδιοκτησία εντός ΟΤ							
id1:1426		id2:02		Σημεία:7		Εμβαδό:301.82 m <sup>2</sup>	
Σημείο	X	Y	μήκος	Σημείο	X	Y	μήκος
6	500039.950	3929067.502	17.18	P13	500053.778	3929059.076	13.36
5	500046.834	3929083.241		8.44	P10	500041.370	3929064.018
8	500054.234	3929079.173	7.51	7	500038.864	3929065.017	2.71
9	500060.815	3929075.555	17.92	6	500039.950	3929067.502	

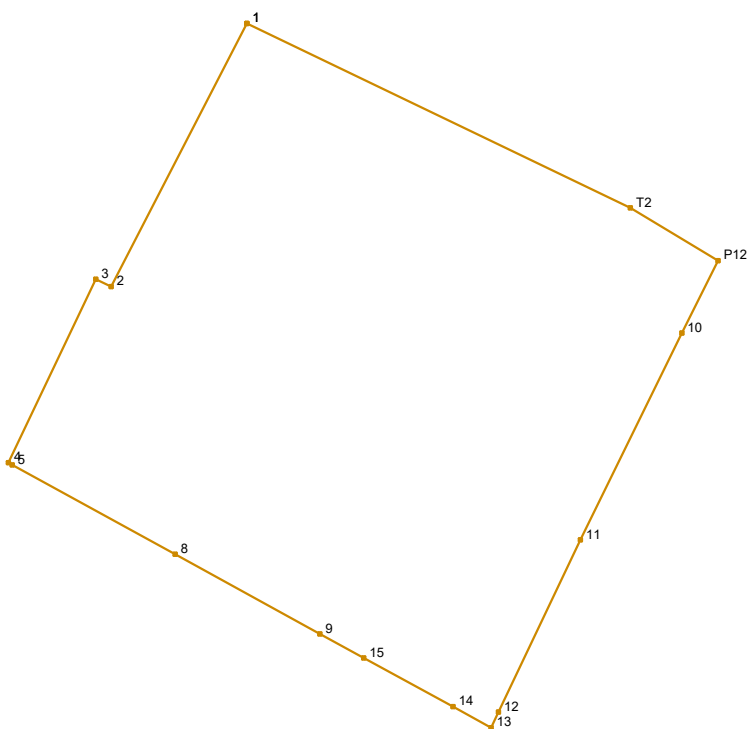

Νέα ιδιοκτησία εντός ΟΤ							
id1:1426		id2:03		Σημεία:15		Εμβαδό:571.32 m <sup>2</sup>	
Σημείο	X	Y	μήκος	Σημείο	X	Y	μήκος
1	500057.499	3929103.320	19.36	15	500062.816	3929074.455	2.28
T2	500074.944	3929094.922	4.65	9	500060.815	3929075.555	7.51
P12	500078.930	3929092.533	3.68	8	500054.234	3929079.173	8.44
10	500077.285	3929089.244	10.49	5	500046.834	3929083.241	0.20
11	500072.662	3929079.832	8.67	4	500046.661	3929083.335	9.25
12	500068.942	3929072.002	0.79	3	500050.630	3929091.686	0.77
13	500068.603	3929071.288	1.98	2	500051.328	3929091.354	13.46
14	500066.868	3929072.247	4.61	1	500057.499	3929103.320	

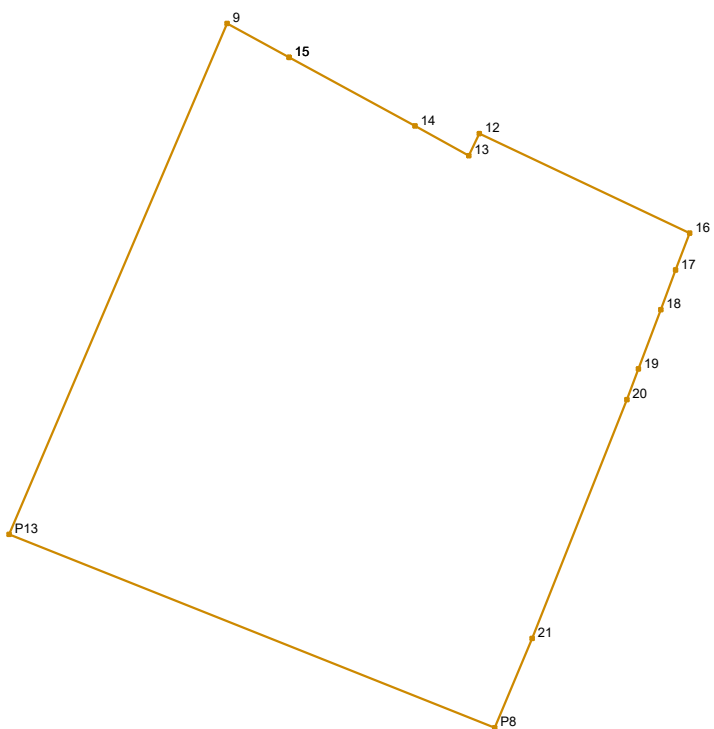

Νέα ιδιοκτησία εντός ΟΤ							
id1:1426		id2:04		Σημεία:13		Εμβαδό:289.71 m <sup>2</sup>	
Σημείο	X	Y	μήκος	Σημείο	X	Y	μήκος
15	500062.816	3929074.455	4.61	19	500074.073	3929064.415	1.06
14	500066.868	3929072.247	1.98	20	500073.702	3929063.420	8.28
13	500068.603	3929071.288	0.79	21	500070.653	3929055.719	3.13
12	500068.942	3929072.002	7.51	P8	500069.443	3929052.836	16.86
16	500075.725	3929068.787	1.27	P13	500053.778	3929059.076	17.92
17	500075.278	3929067.601	1.37	9	500060.815	3929075.555	2.28
18	500074.796	3929066.322	2.04	15	500062.816	3929074.455	

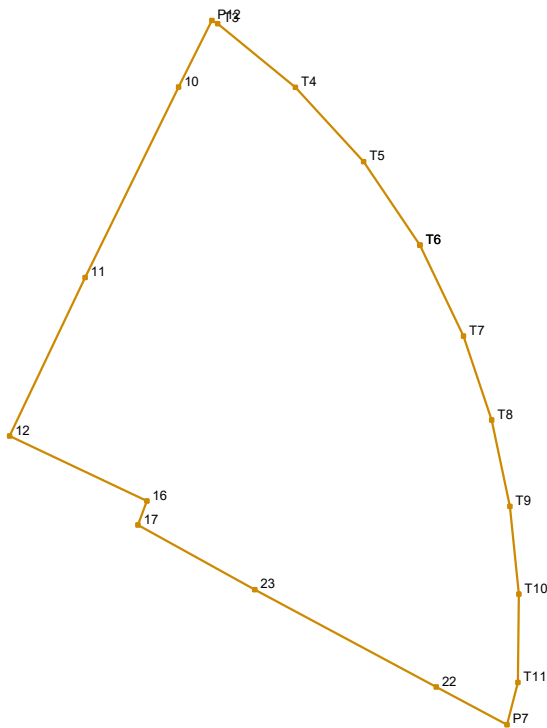

Νέα ιδιοκτησία εντός ΟΤ							
id1:1426		id2:05		Σημεία:18		Εμβαδό:468.48 m <sup>2</sup>	
Σημείο	X	Y	μήκος	Σημείο	X	Y	μήκος
T6	500089.200	3929081.426	4.98	16	500075.725	3929068.787	7.51
T7	500091.361	3929076.940	4.36	12	500068.942	3929072.002	8.67
T8	500092.742	3929072.799	4.36	11	500072.662	3929079.832	10.49
T9	500093.655	3929068.531	4.36	10	500077.285	3929089.244	3.68
T10	500094.090	3929064.188	4.36	P12	500078.930	3929092.533	0.33
T11	500094.041	3929059.823	2.15	T3	500079.210	3929092.366	4.97
P7	500093.499	3929057.742	3.95	T4	500083.060	3929089.218	4.97
22	500090.015	3929059.610	10.18	T5	500086.414	3929085.546	4.97
23	500081.039	3929064.419	6.58	T6	500089.200	3929081.426	
17	500075.278	3929067.601	1.27				

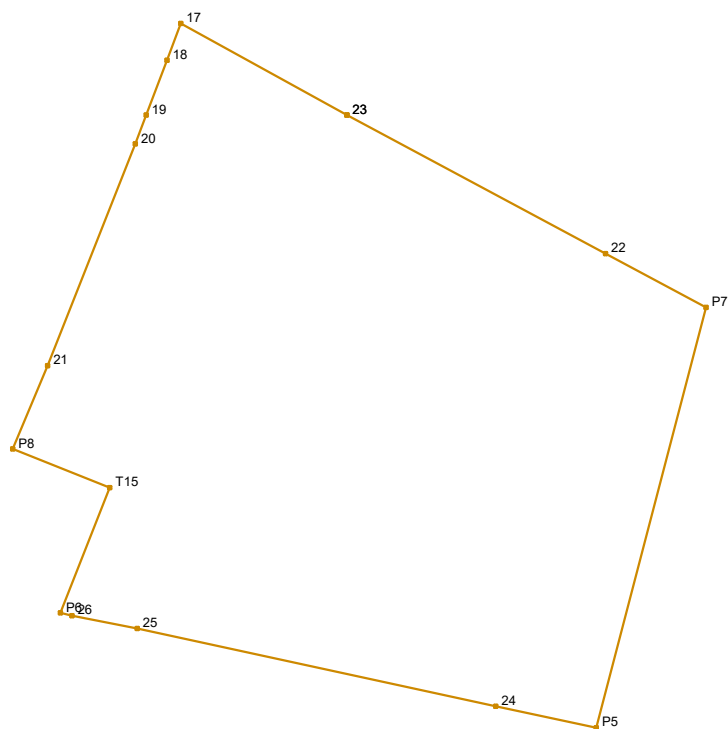

Νέα ιδιοκτησία εντός ΟΤ							
id1:1426		id2:06		Σημεία:15		Εμβαδό:368.92 m <sup>2</sup>	
Σημείο	X	Y	μήκος	Σημείο	X	Y	μήκος
23	500081.039	3929064.419	10.18	T15	500072.813	3929051.493	3.63
22	500090.015	3929059.610	3.95	P8	500069.443	3929052.836	3.13
P7	500093.499	3929057.742	15.07	21	500070.653	3929055.719	8.28
P5	500089.695	3929043.158	3.57	20	500073.702	3929063.420	1.06
24	500086.207	3929043.904	12.73	19	500074.073	3929064.415	2.04
25	500073.769	3929046.600	2.31	18	500074.796	3929066.322	1.37
26	500071.500	3929047.049	0.41	17	500075.278	3929067.601	6.58
P6	500071.102	3929047.151	4.67	23	500081.039	3929064.419	



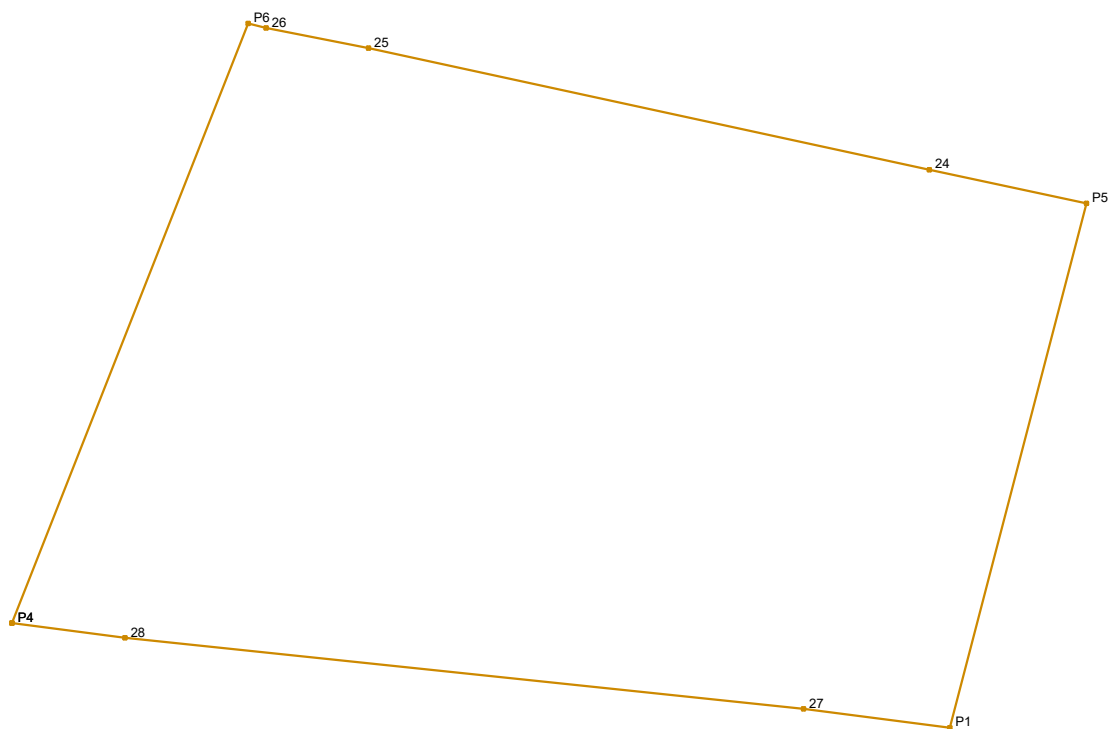

Νέα ιδιοκτησία εντός ΟΤ							
id1:1426		id2:07		Σημεία:9		Εμβαδό:258.57 m <sup>2</sup>	
Σημείο	X	Y	μήκος	Σημείο	X	Y	μήκος
P4	500065.864	3929033.852	14.29	P5	500089.695	3929043.158	12.02
P6	500071.102	3929047.151	0.41	P1	500086.663	3929031.531	3.27
26	500071.500	3929047.049	2.31	27	500083.415	3929031.948	15.13
25	500073.769	3929046.600	12.73	28	500068.371	3929033.524	2.53
24	500086.207	3929043.904	3.57	P4	500065.864	3929033.852	

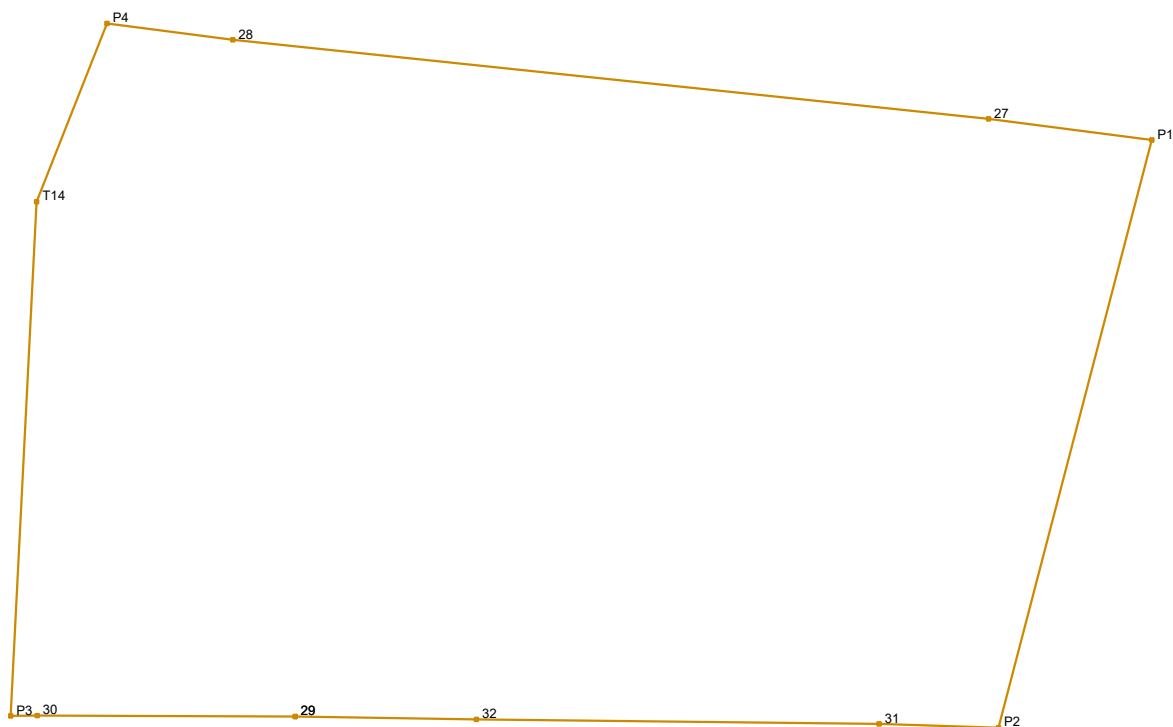

Νέα ιδιοκτησία εντός ΟΤ							
id1:1426		id2:08		Σημεία:11		Εμβαδό:266.54 m <sup>2</sup>	
Σημείο	X	Y	μήκος	Σημείο	X	Y	μήκος
29	500069.612	3929020.053	5.14	27	500083.415	3929031.948	3.27
30	500064.477	3929020.071		0.53	P1	500086.663	
P3	500063.950	3929020.068	10.24		P2	500083.612	3929019.830
T14	500064.464	3929030.298		3.82	31	500081.235	3929019.906
P4	500065.864	3929033.852	2.53		32	500073.218	3929019.998
28	500068.371	3929033.524		15.13	29	500069.612	3929020.053

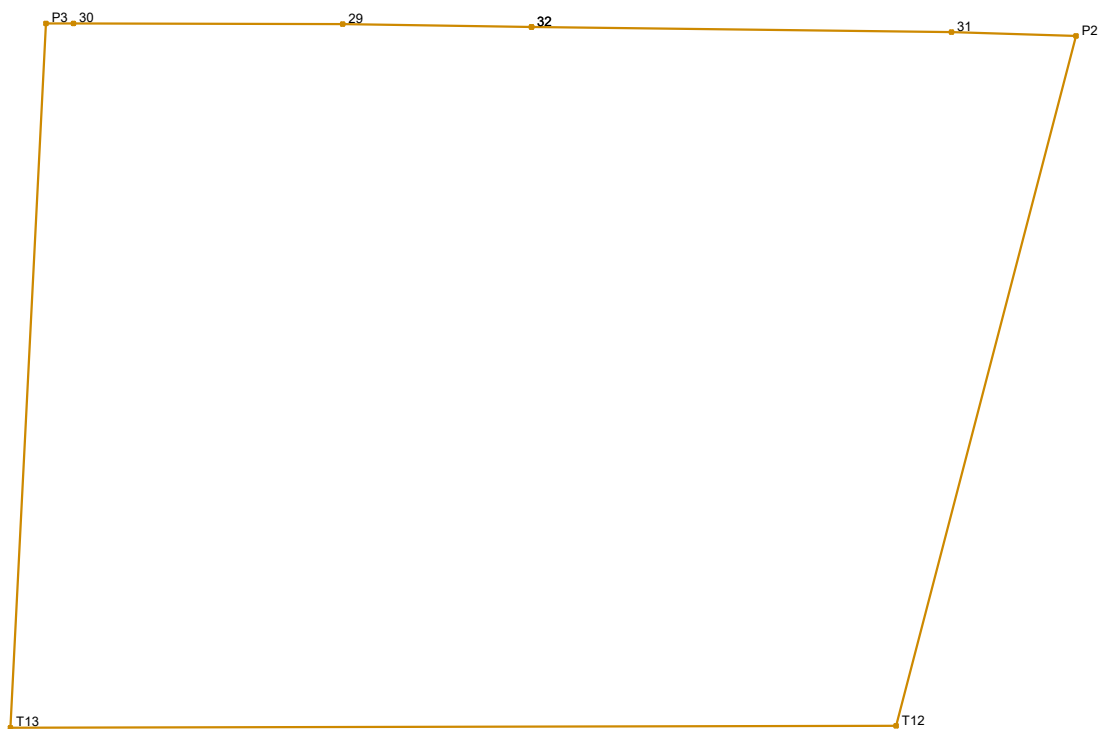

Νέα ιδιοκτησία εντός ΟΤ							
id1:1426		id2:09		Σημεία:8		Εμβαδό:244.20 m <sup>2</sup>	
Σημείο	X	Y	μήκος	Σημείο	X	Y	μήκος
32	500073.218	3929019.998	8.02	P3	500063.950	3929020.068	0.53
31	500081.235	3929019.906		2.38	30	500064.477	3929020.071
P2	500083.612	3929019.830	13.61		29	500069.612	3929020.053
T12	500080.178	3929006.663		16.90	32	500073.218	3929019.998
T13	500063.275	3929006.626	13.46				

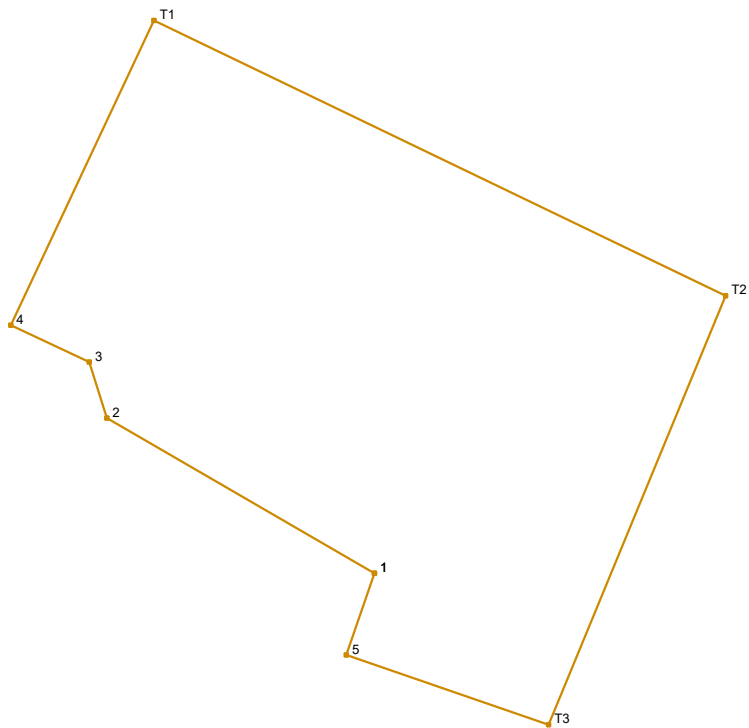

Νέα ιδιοκτησία εντός ΟΤ							
id1:1427		id2:01		Σημεία:8		Εμβαδό:2650.02 m <sup>2</sup>	
Σημείο	X	Y	μήκος	Σημείο	X	Y	μήκος
1	499992.217	3929090.000	31.01	T2	500027.401	3929117.810	46.51
2	499965.393	3929105.550	5.88	T3	500009.649	3929074.821	21.43
3	499963.623	3929111.155	8.67	5	499989.391	3929081.822	8.65
4	499955.774	3929114.833	33.75	1	499992.217	3929090.000	
T1	499970.097	3929145.397	63.60				

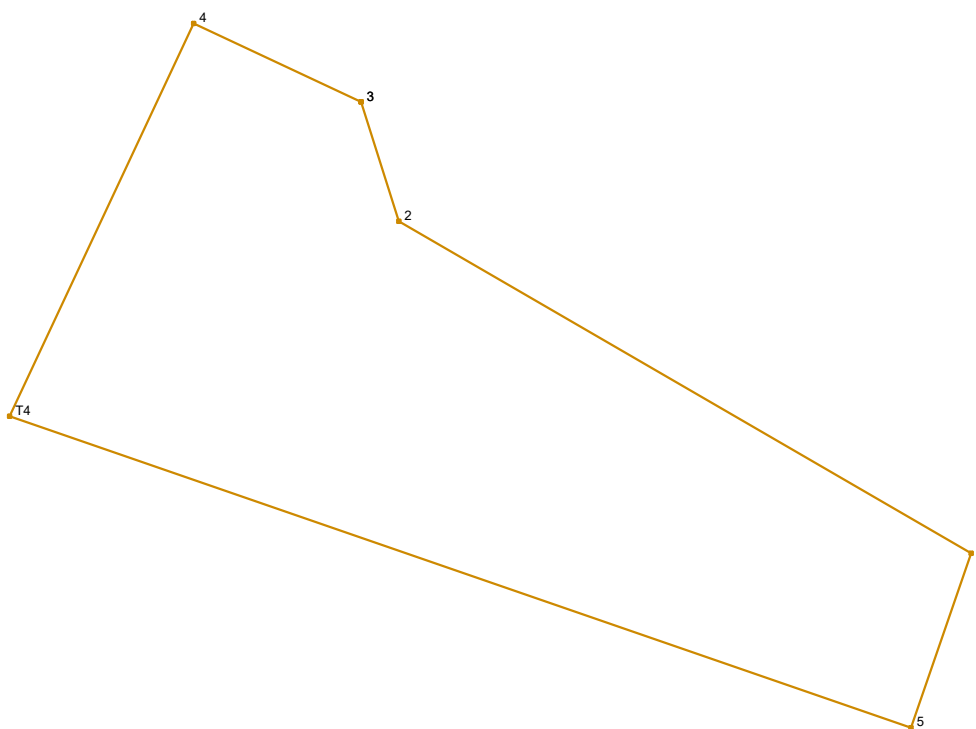

Νέα ιδιοκτησία εντός ΟΤ							
id1:1427		id2:02		Σημεία:6		Εμβαδό:605.00 m <sup>2</sup>	
Σημείο	X	Y	μήκος	Σημείο	X	Y	μήκος
3	499963.623	3929111.155	5.88	T4	499947.146	3929096.422	20.33
2	499965.393	3929105.550	31.01	4	499955.774	3929114.833	8.67
1	499992.217	3929090.000	8.65	3	499963.623	3929111.155	
5	499989.391	3929081.822	44.70				

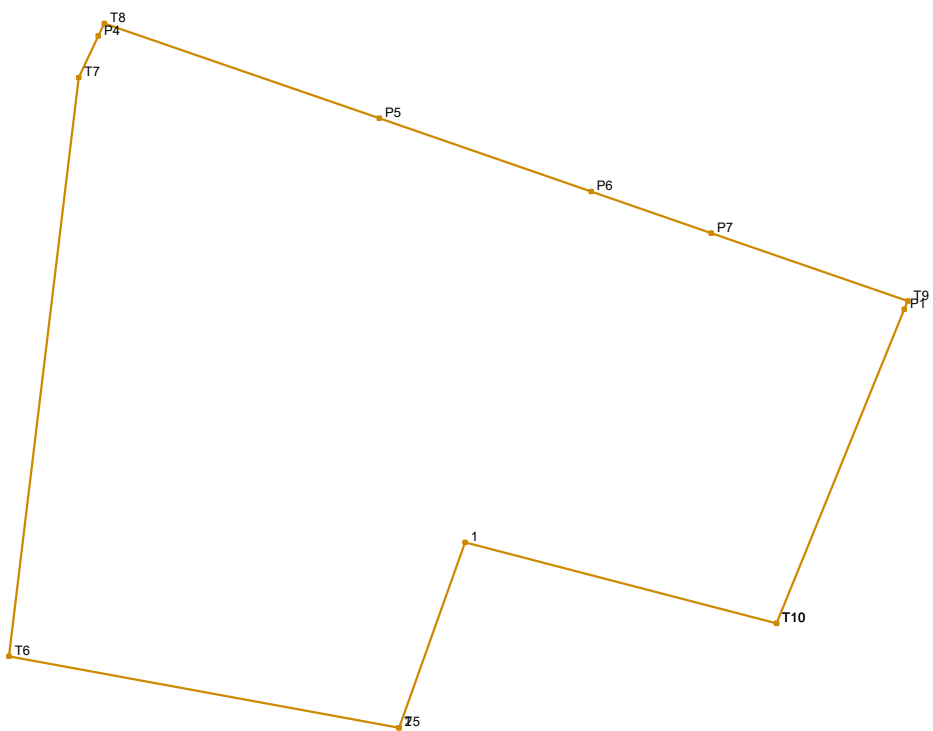

Νέα ιδιοκτησία εντός ΟΤ							
id1:1428		id2:01		Σημεία:13		Εμβαδό:2071.53 m <sup>2</sup>	
Σημείο	X	Y	μήκος	Σημείο	X	Y	μήκος
T10	499993.160	3929047.606		T8	499944.586	3929090.958	21.02
1	499970.652	3929053.463	23.26	P5	499964.453	3929084.092	16.21
2	499965.892	3929040.068	14.22	P6	499979.771	3929078.798	9.17
T5	499965.862	3929040.073	0.03	P7	499988.440	3929075.802	15.03
T6	499937.693	3929045.234	28.64	T9	500002.645	3929070.894	0.65
T7	499942.753	3929087.048	42.12	P1	500002.402	3929070.296	24.50
P4	499944.155	3929090.039	3.30	T10	499993.160	3929047.606	
			1.02				

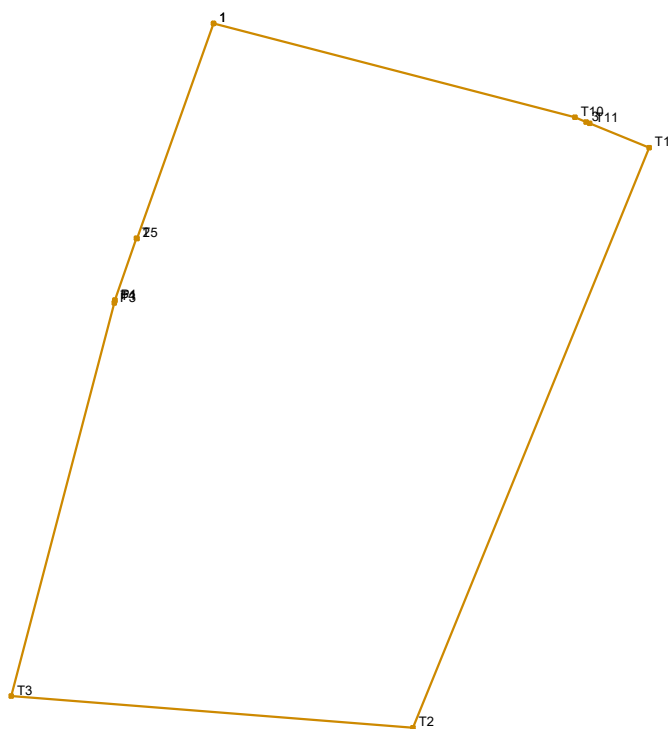

Νέα ιδιοκτησία εντός ΟΤ							
id1:1428		id2:02		Σημεία:12		Εμβαδό:1111.00 m <sup>2</sup>	
Σημείο	X	Y	μήκος	Σημείο	X	Y	μήκος
1	499970.652	3929053.463	23.26	P3	499964.474	3929036.051	0.10
T10	499993.160	3929047.606		0.75	T4	499964.500	3929036.150
3	499993.855	3929047.323	0.25	P1	499964.527	3929036.227	4.07
T11	499994.087	3929047.229		4.00	T5	499965.862	3929040.073
T1	499997.791	3929045.720	39.00	2	499965.892	3929040.068	14.22
T2	499983.081	3929009.601		25.09	1	499970.652	
T3	499958.067	3929011.578	25.30				

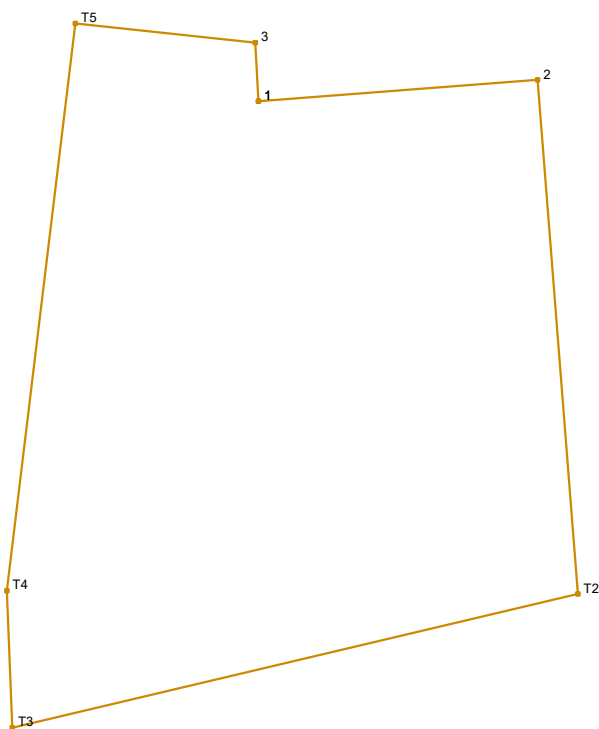

Νέα ιδιοκτησία εντός ΟΤ							
id1:1429		id2:01		Σημεία:7		Εμβαδό:4052.72 m <sup>2</sup>	
Σημείο	X	Y	μήκος	Σημείο	X	Y	μήκος
1	499949.946	3928965.052		T4	499921.235	3928909.215	65.20
2	499981.813	3928967.498	31.96	T5	499929.066	3928973.938	20.64
T2	499986.400	3928908.846	58.83	3	499949.591	3928971.722	6.68
T3	499921.888	3928893.577	66.29	1	499949.946	3928965.052	
			15.65				



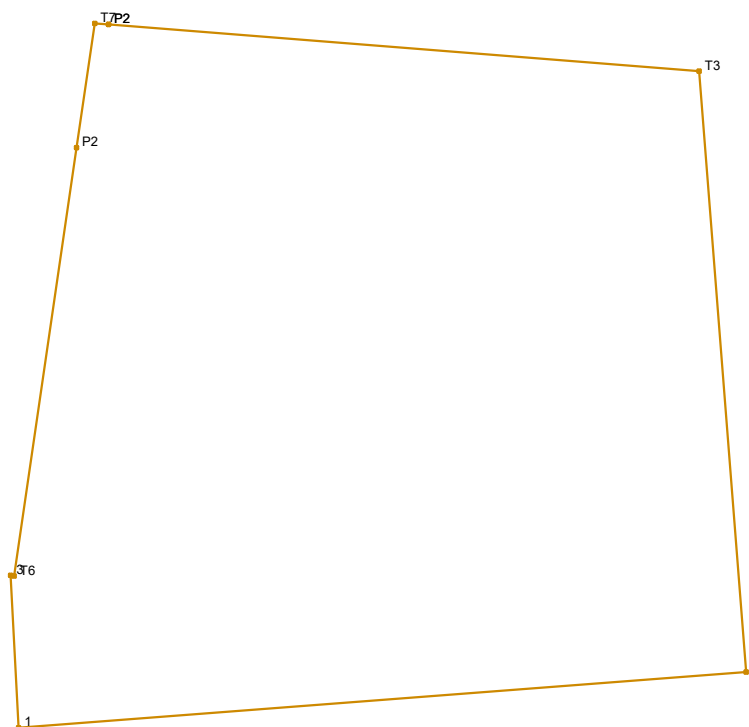

Νέα ιδιοκτησία εντός ΟΤ							
id1:1429		id2:02N		Σημεία:8		Εμβαδό:848.39 m <sup>2</sup>	
Σημείο	X	Y	μήκος	Σημείο	X	Y	μήκος
P2	499953.889	3928995.858		T6	499949.754	3928971.704	
			25.95				18.95
T3	499979.756	3928993.814		P2	499952.483	3928990.457	
			26.40				5.51
2	499981.813	3928967.498		T7	499953.277	3928995.907	
			31.96				0.61
1	499949.946	3928965.052		P2	499953.889	3928995.858	
			6.68				
3	499949.591	3928971.722					
			0.16				

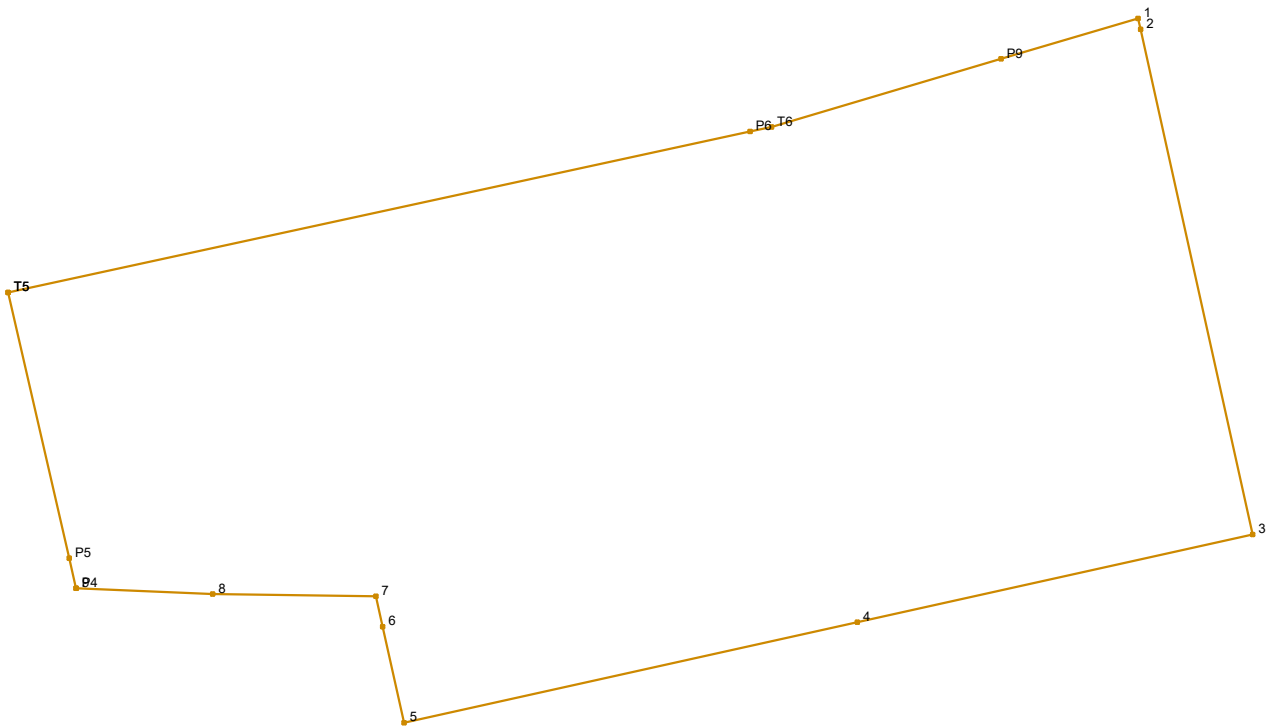

Νέα ιδιοκτησία εντός ΟΤ							
id1:1430		id2:01N		Σημεία:15		Εμβαδό:581.43 m <sup>2</sup>	
Σημείο	X	Y	μήκος	Σημείο	X	Y	μήκος
T5	499856.246	3928925.145	24.88	5	499869.223	3928911.050	3.22
P6	499880.563	3928930.423	0.72	6	499868.526	3928914.196	1.03
T6	499881.265	3928930.576	7.85	7	499868.303	3928915.199	5.35
P9	499888.794	3928932.805	4.68	8	499862.951	3928915.271	4.48
1	499893.280	3928934.133	0.37	9	499858.479	3928915.457	0.00
2	499893.360	3928933.774	16.96	P4	499858.475	3928915.456	1.02
3	499897.032	3928917.219	13.26	P5	499858.248	3928916.446	8.93
4	499884.083	3928914.346	15.22	T5	499856.246	3928925.145	

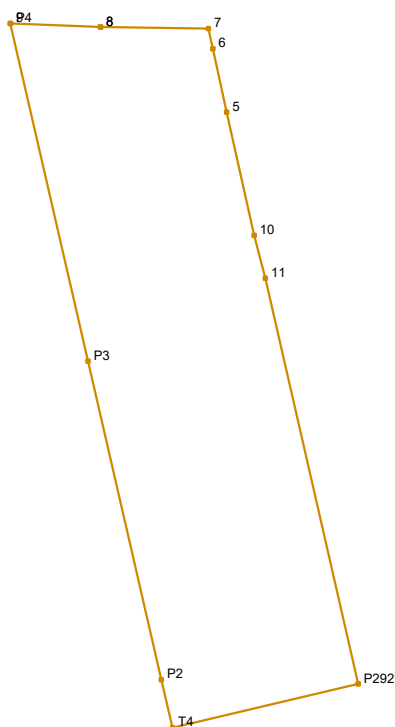

Νέα ιδιοκτησία εντός ΟΤ							
id1:1430		id2:02		Σημεία:12		Εμβαδό:328.27 m <sup>2</sup>	
Σημείο	X	Y	μήκος	Σημείο	X	Y	μήκος
8	499862.951	3928915.271	5.35	T4	499866.527	3928880.473	2.46
7	499868.303	3928915.199	1.03	P2	499865.976	3928882.865	16.23
6	499868.526	3928914.196	3.22	P3	499862.336	3928898.683	17.21
5	499869.223	3928911.050	6.27	P4	499858.475	3928915.456	0.00
10	499870.581	3928904.931	2.21	9	499858.479	3928915.457	4.48
11	499871.138	3928902.791	20.66	8	499862.951	3928915.271	
P292	499875.753	3928882.657	9.48				

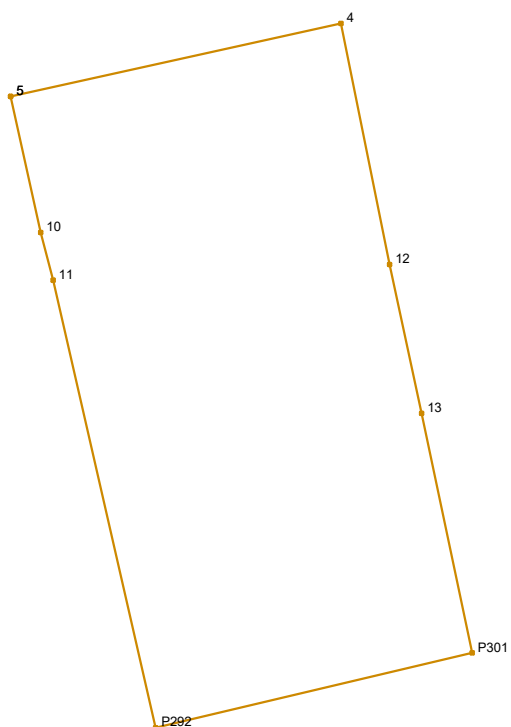

Νέα ιδιοκτησία εντός ΟΤ							
id1:1430		id2:03		Σημεία:8		Εμβαδό:432.48 m <sup>2</sup>	
Σημείο	X	Y	μήκος	Σημείο	X	Y	μήκος
5	499869.223	3928911.050	15.22	P292	499875.753	3928882.657	20.66
4	499884.083	3928914.346	11.07	11	499871.138	3928902.791	2.21
12	499886.280	3928903.497	6.86	10	499870.581	3928904.931	6.27
13	499887.719	3928896.794	11.00	5	499869.223	3928911.050	
P301	499889.983	3928886.025	14.62				

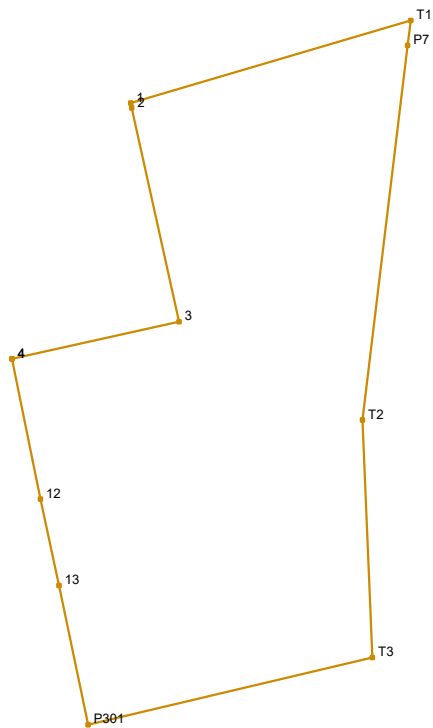

Νέα ιδιοκτησία εντός ΟΤ							
id1:1430		id2:04		Σημεία:11		Εμβαδό:1073.53 m <sup>2</sup>	
Σημείο	X	Y	μήκος	Σημείο	X	Y	μήκος
4	499884.083	3928914.346		T2	499911.209	3928909.610	
			13.26				18.40
3	499897.032	3928917.219		T3	499911.977	3928891.231	
			16.96				22.60
2	499893.360	3928933.774		P301	499889.983	3928886.025	
			0.37				11.00
1	499893.280	3928934.133		13	499887.719	3928896.794	
			22.60				6.86
T1	499914.953	3928940.551		12	499886.280	3928903.497	
			1.96				11.07
P7	499914.718	3928938.605		4	499884.083	3928914.346	
			29.21				

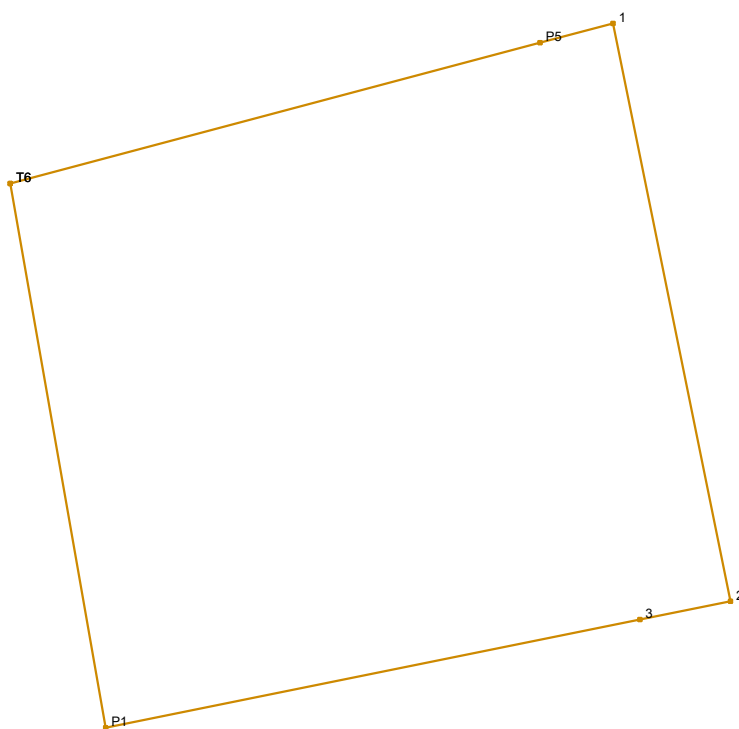

Νέα ιδιοκτησία εντός ΟΤ							
id1:1431		id2:01		Σημεία:6		Εμβαδό:217.84 m <sup>2</sup>	
Σημείο	X	Y	μήκος	Σημείο	X	Y	μήκος
T6	499843.882	3928998.195	13.49	3	499859.379	3928987.460	13.42
P5	499856.919	3929001.658		P1	499846.229	3928984.801	
1	499858.716	3929002.135	1.86	T6	499843.882	3928998.195	13.60
2	499861.607	3928987.910	14.52				
			2.27				

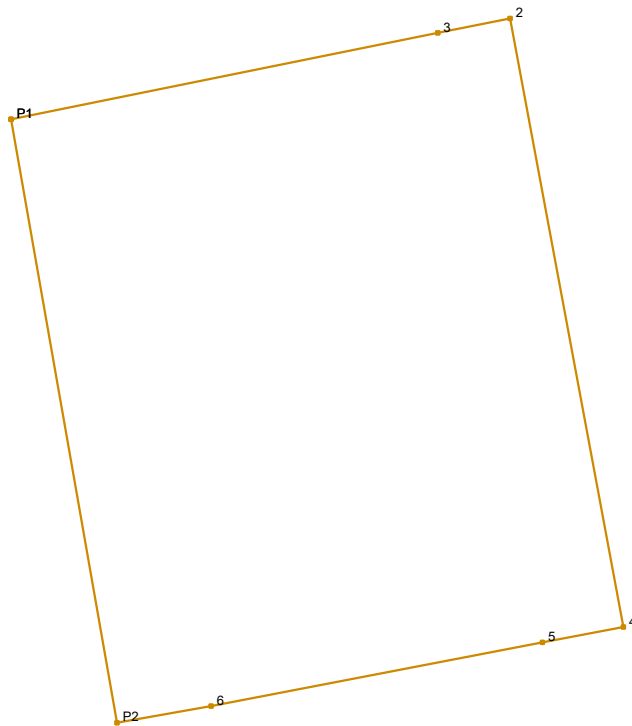

Νέα ιδιοκτησία εντός ΟΤ							
id1:1431		id2:02		Σημεία:7		Εμβαδό:300.00 m <sup>2</sup>	
Σημείο	X	Y	μήκος	Σημείο	X	Y	μήκος
P1	499846.229	3928984.801	13.42	5	499862.602	3928968.670	10.40
3	499859.379	3928987.460		2.27	6	499852.389	3928966.711
2	499861.607	3928987.910	19.08	P2	499849.490	3928966.196	18.89
4	499865.104	3928969.150	2.55	P1	499846.229	3928984.801	

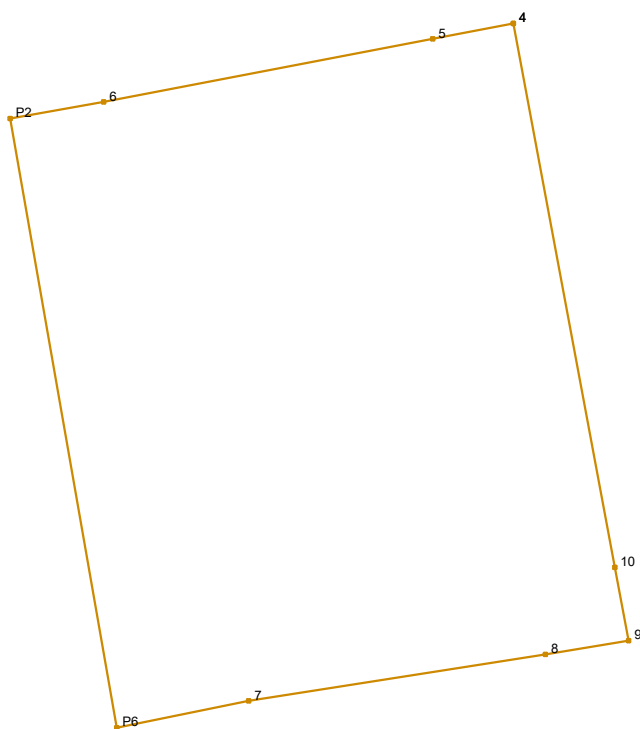

Νέα ιδιοκτησία εντός ΟΤ							
id1:1431		id2:03		Σημεία:9		Εμβαδό:307.98 m <sup>2</sup>	
Σημείο	X	Y	μήκος	Σημείο	X	Y	μήκος
4	499865.104	3928969.150	17.16	P6	499852.802	3928947.298	19.19
10	499868.249	3928952.277	2.31	P2	499849.490	3928966.196	2.94
9	499868.672	3928950.002	2.61	6	499852.389	3928966.711	10.40
8	499866.099	3928949.574	9.32	5	499862.602	3928968.670	2.55
7	499856.894	3928948.129	4.18	4	499865.104	3928969.150	



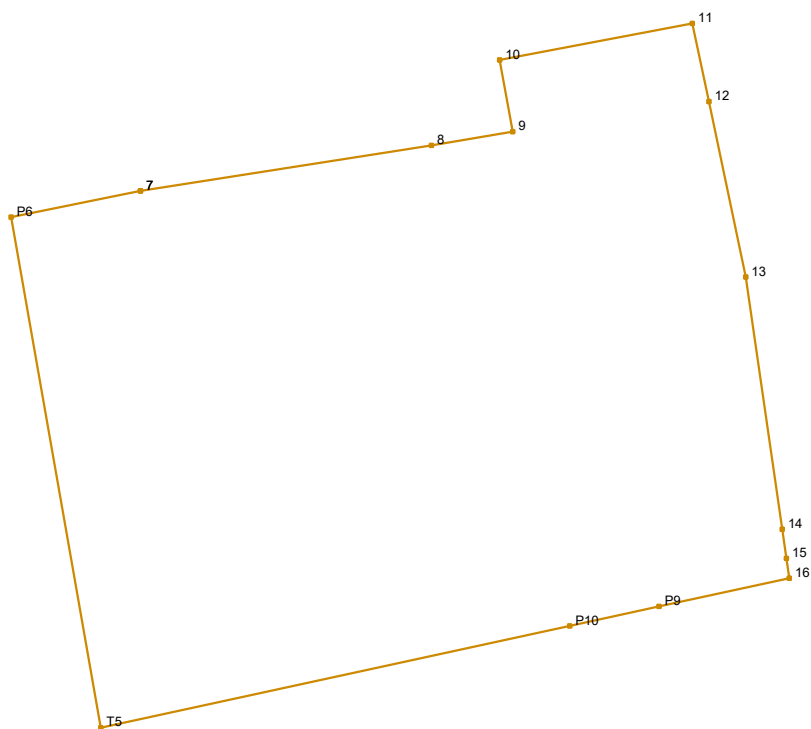

Νέα ιδιοκτησία εντός ΟΤ							
id1:1431		id2:04		Σημεία:14		Εμβαδό:372.24 m <sup>2</sup>	
Σημείο	X	Y	μήκος	Σημείο	X	Y	μήκος
7	499856.894	3928948.129	9.32	15	499877.329	3928936.509	0.63
8	499866.099	3928949.574		16	499877.420	3928935.881	
9	499868.672	3928950.002	2.61	P9	499873.291	3928934.985	4.22
10	499868.249	3928952.277	2.31	P10	499870.469	3928934.372	2.89
11	499874.343	3928953.432	6.20	T5	499855.632	3928931.151	15.18
12	499874.872	3928950.957	2.53	P6	499852.802	3928947.298	16.39
13	499876.042	3928945.409	5.67	7	499856.894	3928948.129	4.18
14	499877.196	3928937.427	8.07				
			0.93				

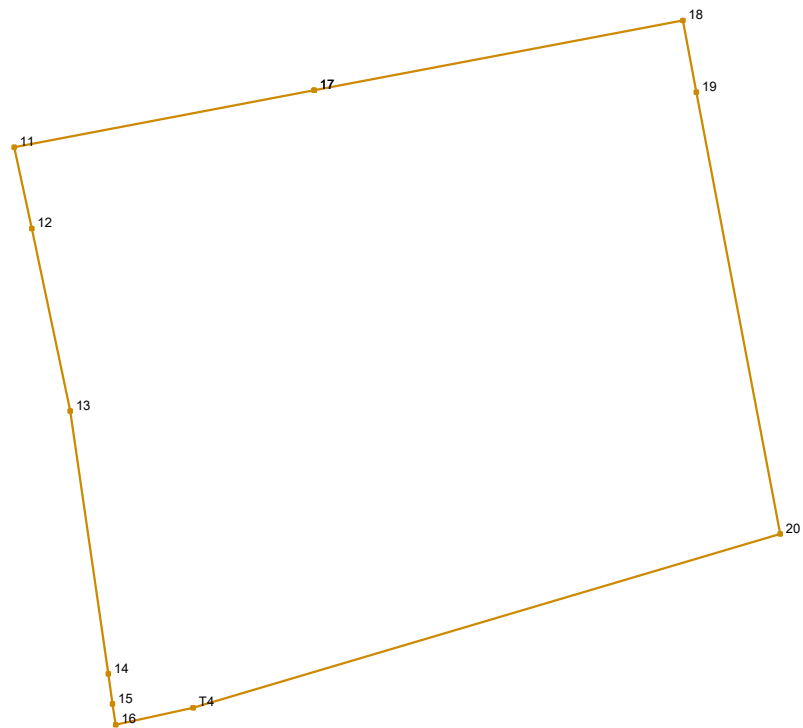

Νέα ιδιοκτησία εντός ΟΤ							
id1:1431		id2:05		Σημεία:11		Εμβαδό:349.46 m <sup>2</sup>	
Σημείο	X	Y	μήκος	Σημείο	X	Y	μήκος
17	499883.451	3928955.160	11.40	15	499877.329	3928936.509	0.93
18	499894.656	3928957.284		2.22	14	499877.196	3928937.427
19	499895.069	3928955.103	13.67	13	499876.042	3928945.409	5.67
20	499897.616	3928941.675	18.61	12	499874.872	3928950.957	2.53
Τ4	499879.775	3928936.392	2.41	11	499874.343	3928953.432	9.27
16	499877.420	3928935.881	0.63	17	499883.451	3928955.160	

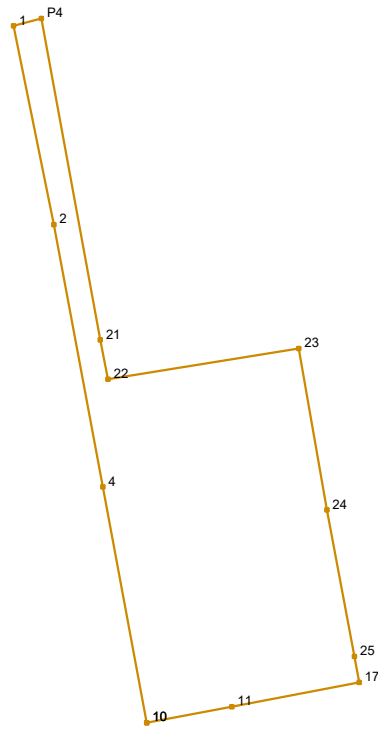

Νέα ιδιοκτησία εντός ΟΤ							
id1:1431		id2:06		Σημεία:12		Εμβαδό:427.96 m <sup>2</sup>	
Σημείο	X	Y	μήκος	Σημείο	X	Y	μήκος
10	499868.249	3928952.277	17.16	23	499879.129	3928979.041	11.71
4	499865.104	3928969.150	19.08	24	499881.135	3928967.502	10.66
2	499861.607	3928987.910	14.52	25	499883.101	3928957.027	1.90
1	499858.716	3929002.135	2.07	17	499883.451	3928955.160	9.27
P4	499860.716	3929002.666	23.39	11	499874.343	3928953.432	6.20
21	499864.931	3928979.655	2.86	10	499868.249	3928952.277	
22	499865.475	3928976.842	13.83				

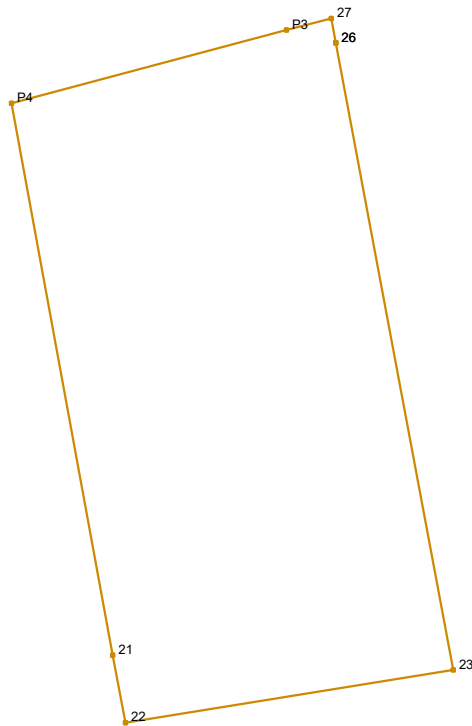

Νέα ιδιοκτησία εντός ΟΤ							
id1:1431		id2:07		Σημεία:7		Εμβαδό:371.88 m <sup>2</sup>	
Σημείο	X	Y	μήκος	Σημείο	X	Y	μήκος
26	499874.234	3929005.187		P4	499860.716	3929002.666	
			26.60				11.87
23	499879.129	3928979.041		P3	499872.185	3929005.712	
			13.83				1.92
22	499865.475	3928976.842		27	499874.044	3929006.205	
			2.86				1.04
21	499864.931	3928979.655		26	499874.234	3929005.187	
			23.39				

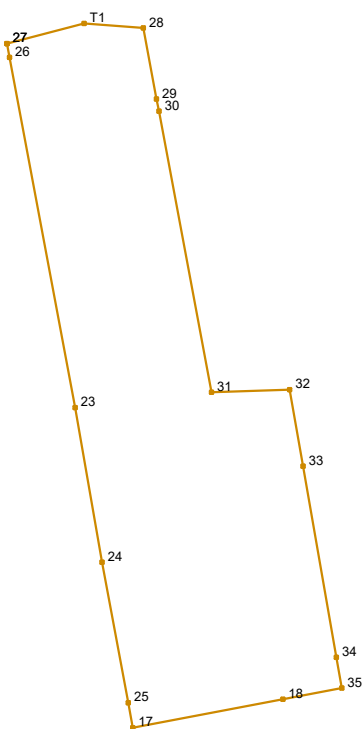

Νέα ιδιοκτησία εντός ΟΤ							
id1:1431		id2:08		Σημεία:16		Εμβαδό:663.99 m <sup>2</sup>	
Σημείο	X	Y	μήκος	Σημείο	X	Y	μήκος
27	499874.044	3929006.205	5.96	35	499899.037	3928958.115	4.46
T1	499879.800	3929007.734	4.44	18	499894.656	3928957.284	11.40
28	499884.226	3929007.384	5.40	17	499883.451	3928955.160	1.90
29	499885.220	3929002.071	0.92	25	499883.101	3928957.027	10.66
30	499885.389	3929001.169	21.33	24	499881.135	3928967.502	11.71
31	499889.314	3928980.207	5.83	23	499879.129	3928979.041	26.60
32	499895.142	3928980.399	5.81	26	499874.234	3929005.187	1.04
33	499896.142	3928974.675	14.47	27	499874.044	3929006.205	
34	499898.635	3928960.418	2.34				

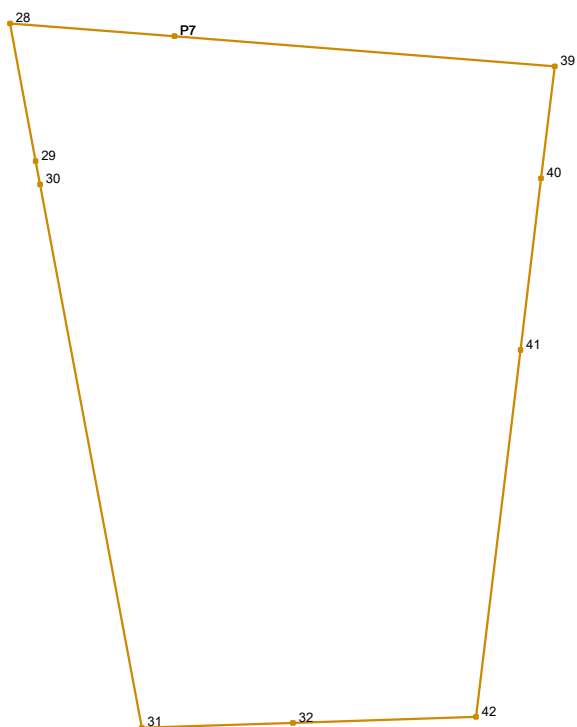

Νέα ιδιοκτησία εντός ΟΤ							
id1:1431		id2:09		Σημεία:10		Εμβαδό:442.49 m <sup>2</sup>	
Σημείο	X	Y	μήκος	Σημείο	X	Y	μήκος
P7	499890.577	3929006.882	14.71	31	499889.314	3928980.207	21.33
39	499905.243	3929005.722		4.35	30	499885.389	
40	499904.721	3929001.403	6.66	29	499885.220	3929002.071	5.40
41	499903.920	3928994.786	14.26	28	499884.226	3929007.384	6.37
42	499902.207	3928980.630	7.07	P7	499890.577	3929006.882	
32	499895.142	3928980.399	5.83				

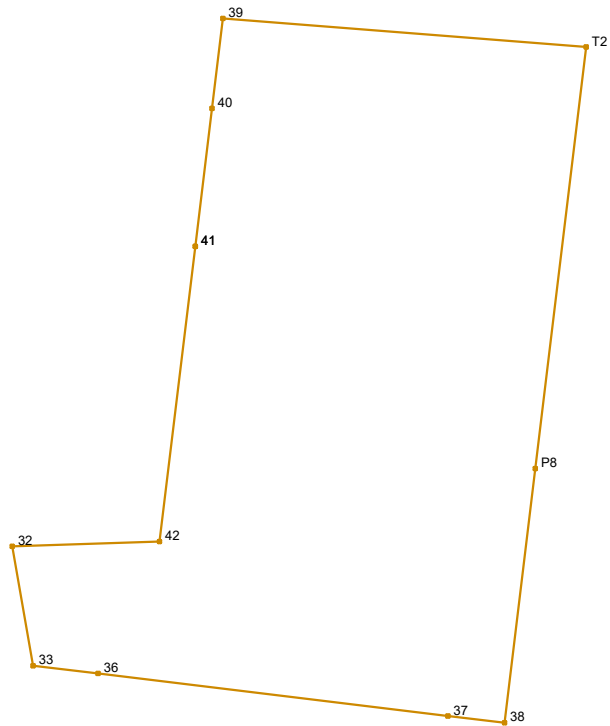

Νέα ιδιοκτησία εντός ΟΤ							
id1:1431		id2:10N		Σημεία:11		Εμβαδό:601.81 m <sup>2</sup>	
Σημείο	X	Y	μήκος	Σημείο	X	Y	μήκος
41	499903.920	3928994.786	6.66	37	499916.032	3928972.269	16.90
40	499904.721	3929001.403	4.35	36	499899.253	3928974.299	3.13
39	499905.243	3929005.722	17.48	33	499896.142	3928974.675	5.81
T2	499922.673	3929004.345	20.37	32	499895.142	3928980.399	7.07
P8	499920.226	3928984.126	12.28	42	499902.207	3928980.630	14.26
38	499918.752	3928971.939	2.74	41	499903.920	3928994.786	

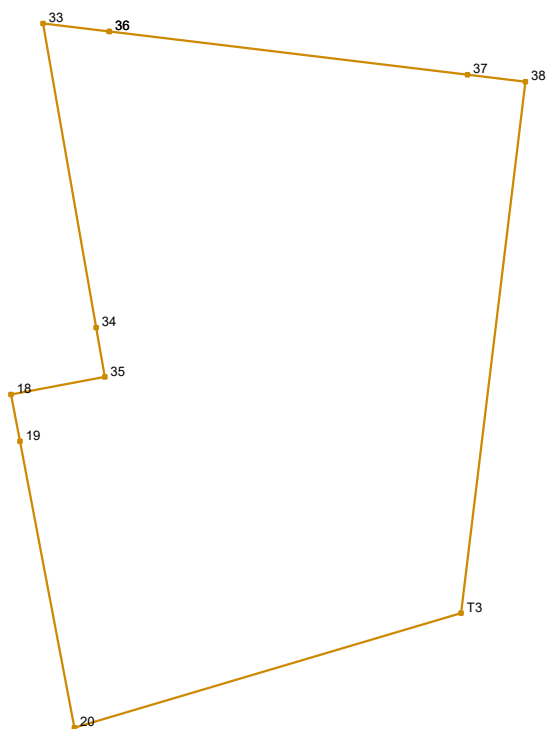

Νέα ιδιοκτησία εντός ΟΤ							
id1:1431		id2:11		Σημεία:10		Εμβαδό:588.44 m <sup>2</sup>	
Σημείο	X	Y	μήκος	Σημείο	X	Y	μήκος
36	499899.253	3928974.299		18	499894.656	3928957.284	
			16.90				4.46
37	499916.032	3928972.269		35	499899.037	3928958.115	
			2.74				2.34
38	499918.752	3928971.939		34	499898.635	3928960.418	
			25.08				14.47
T3	499915.739	3928947.041		33	499896.142	3928974.675	
			18.90				3.13
20	499897.616	3928941.675		36	499899.253	3928974.299	
			13.67				
19	499895.069	3928955.103					
			2.22				



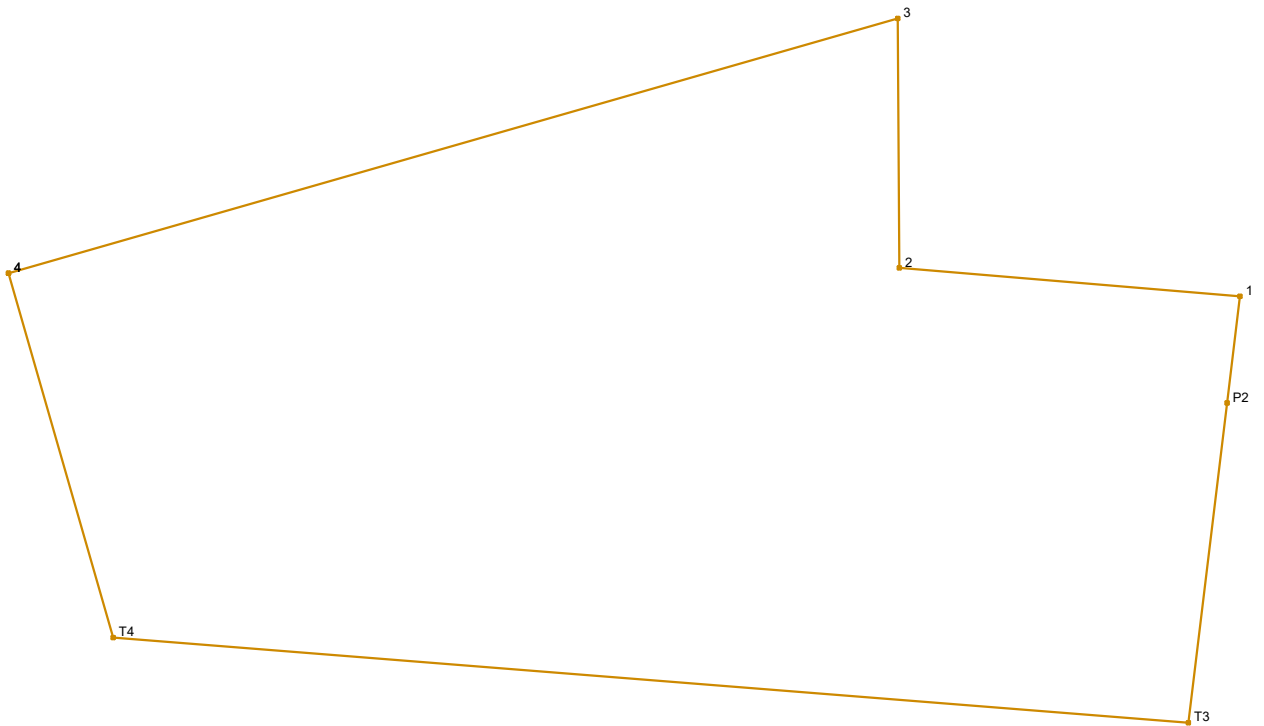

Νέα ιδιοκτησία εντός ΟΤ							
id1:1432		id2:01		Σημεία:7		Εμβαδό:1259.01 m <sup>2</sup>	
Σημείο	X	Y	μήκος	Σημείο	X	Y	μήκος
4	499868.872	3929035.228		P2	499925.679	3929029.187	
			43.12				15.01
3	499910.323	3929047.118		T3	499923.875	3929014.281	
			11.63				50.29
2	499910.396	3929035.484		T4	499873.744	3929018.244	
			15.94				17.67
1	499926.280	3929034.157		4	499868.872	3929035.228	
			5.01				

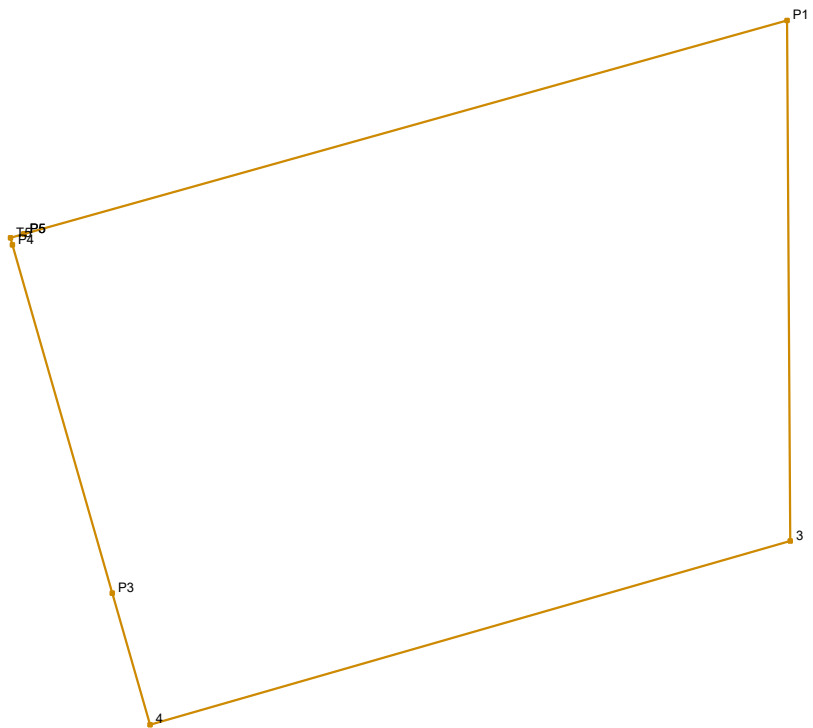

Νέα ιδιοκτησία εντός ΟΤ							
id1:1432		id2:02N		Σημεία:7		Εμβαδό:1556.23 m <sup>2</sup>	
Σημείο	X	Y	μήκος	Σημείο	X	Y	μήκος
P5	499860.705	3929066.998	51.31	P3	499866.431	3929043.737	23.46
P1	499910.110	3929080.833	33.72	P4	499859.962	3929066.291	0.48
3	499910.323	3929047.118	43.12	T5	499859.829	3929066.753	0.91
4	499868.872	3929035.228	8.85	P5	499860.705	3929066.998	

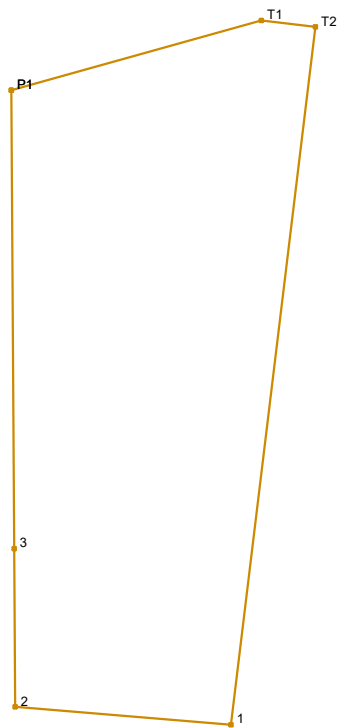

Νέα ιδιοκτησία εντός ΟΤ							
id1:1432		id2:03		Σημεία:6		Εμβαδό:934.81 m <sup>2</sup>	
Σημείο	X	Y	μήκος	Σημείο	X	Y	μήκος
P1	499910.110	3929080.833	19.12	2	499910.396	3929035.484	11.63
T1	499928.523	3929085.989	4.00	3	499910.323	3929047.118	33.72
T2	499932.492	3929085.495	51.71	P1	499910.110	3929080.833	
1	499926.280	3929034.157	15.94				

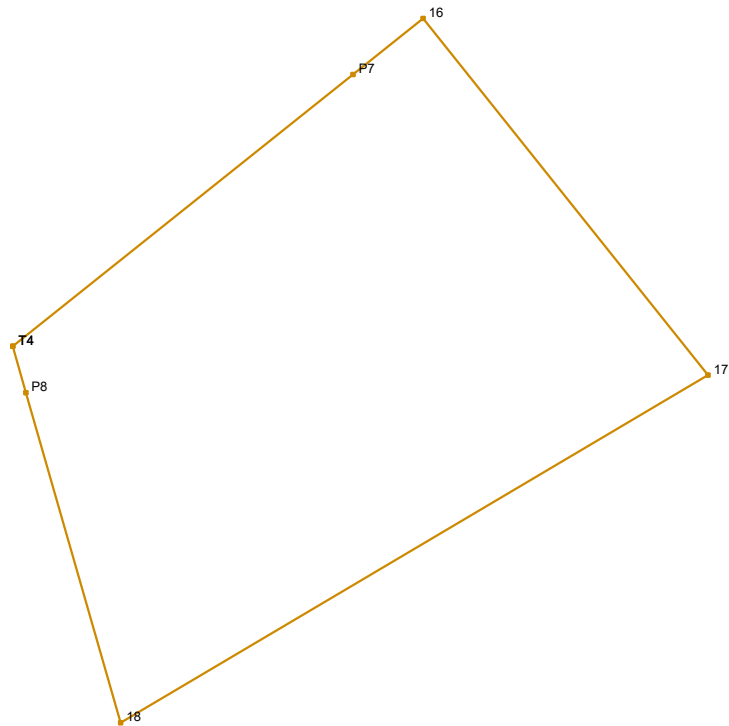

Νέα ιδιοκτησία εντός ΟΤ							
id1:1433		id2:01N		Σημεία:6		Εμβαδό:600.00 m <sup>2</sup>	
Σημείο	X	Y	μήκος	Σημείο	X	Y	μήκος
T4	499848.495	3929106.268	21.37	18	499853.794	3929087.794	16.85
P7	499865.191	3929119.606		4.40	P8	499849.149	3929103.987
16	499868.633	3929122.356	22.39	T4	499848.495	3929106.268	
17	499882.611	3929104.859	33.49				

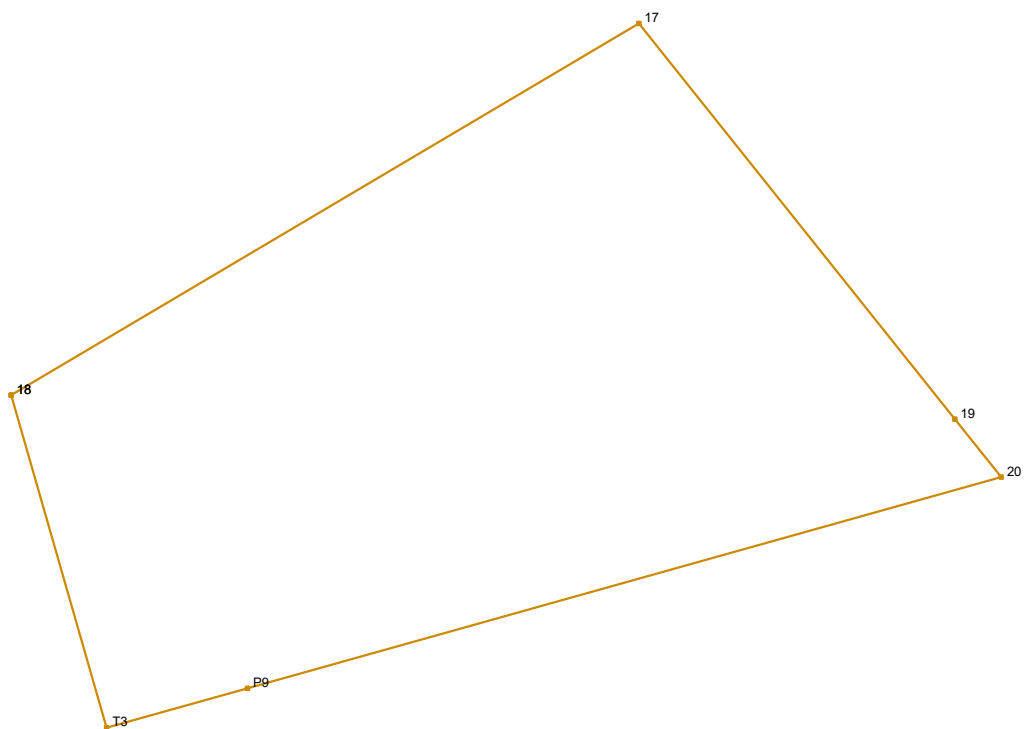

Νέα ιδιοκτησία εντός ΟΤ							
id1:1433		id2:02		Σημεία:6		Εμβαδό:781.14 m <sup>2</sup>	
Σημείο	X	Y	μήκος	Σημείο	X	Y	μήκος
18	499853.794	3929087.794	33.49	P9	499864.639	3929074.331	6.71
17	499882.611	3929104.859		T3	499858.175	3929072.520	15.89
19	499897.123	3929086.692	23.25	18	499853.794	3929087.794	
20	499899.255	3929084.024	3.42				
			35.95				

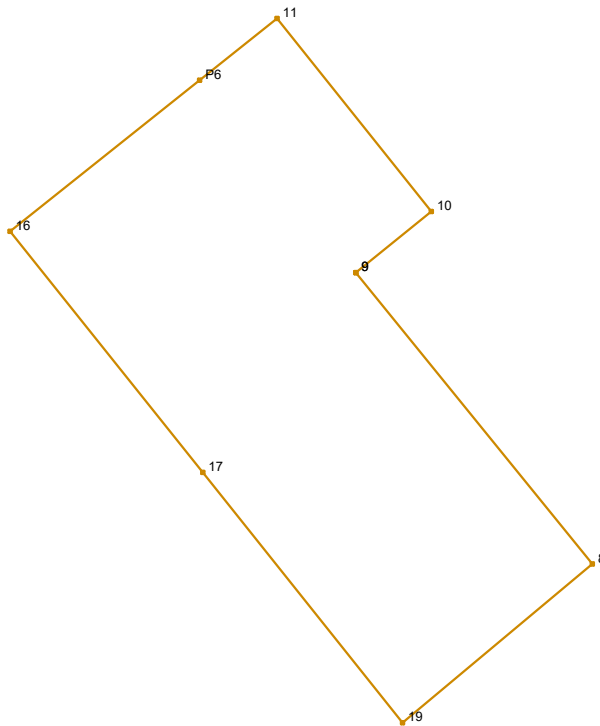

Νέα ιδιοκτησία εντός ΟΤ							
id1:1433		id2:03		Σημεία:8		Εμβαδό:935.76 m <sup>2</sup>	
Σημείο	X	Y	μήκος	Σημείο	X	Y	μήκος
9	499893.723	3929119.362		P6	499882.377	3929133.336	
			27.25				7.20
8	499910.899	3929098.209		11	499888.001	3929137.828	
			17.96				17.94
19	499897.123	3929086.692		10	499899.200	3929123.809	
			23.25				7.06
17	499882.611	3929104.859		9	499893.723	3929119.362	
			22.39				
16	499868.633	3929122.356					
			17.59				

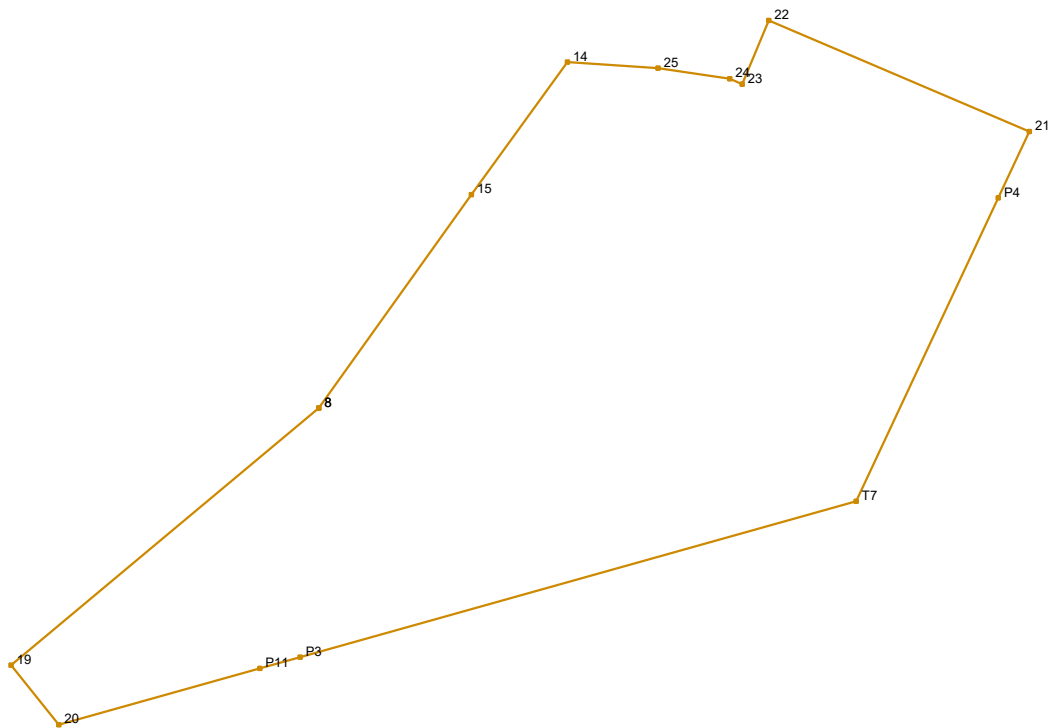

Νέα ιδιοκτησία εντός ΟΤ							
id1:1433		id2:04N		Σημεία:14		Εμβαδό:642.47 m <sup>2</sup>	
Σημείο	X	Y	μήκος	Σημείο	X	Y	μήκος
8	499910.899	3929098.209	11.75	P4	499941.355	3929107.630	15.02
15	499917.739	3929107.767	7.34	T7	499934.981	3929094.029	25.87
14	499922.042	3929113.713	4.08	P3	499910.071	3929087.053	1.87
25	499926.114	3929113.436	3.24	P11	499908.270	3929086.549	9.36
24	499929.321	3929112.968	0.61	20	499899.255	3929084.024	3.42
23	499929.879	3929112.721	3.10	19	499897.123	3929086.692	17.96
22	499931.073	3929115.583	12.69	8	499910.899	3929098.209	
21	499942.749	3929110.606	3.29				

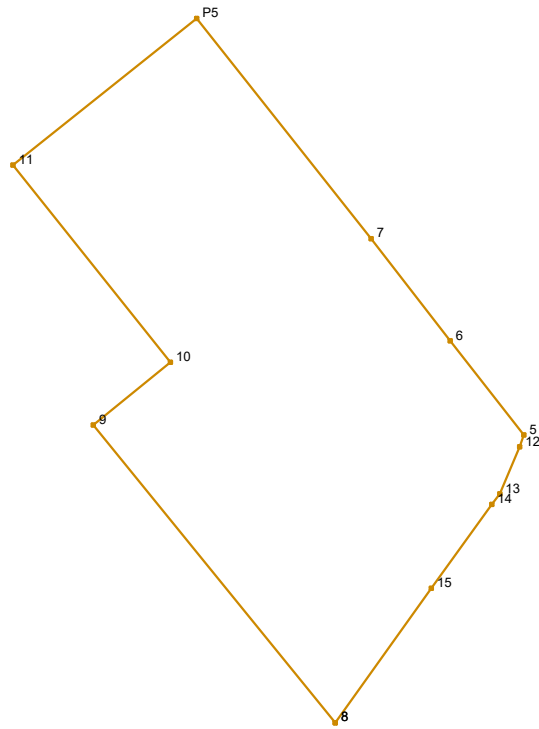

Νέα ιδιοκτησία εντός ΟΤ							
id1:1433		id2:05		Σημεία:12		Εμβαδό:860.61 m <sup>2</sup>	
Σημείο	X	Y	μήκος	Σημείο	X	Y	μήκος
8	499910.899	3929098.209	27.25	5	499924.302	3929118.661	0.90
9	499893.723	3929119.362	7.06	12	499924.001	3929117.813	3.63
10	499899.200	3929123.809	17.94	13	499922.603	3929114.464	0.94
11	499888.001	3929137.828	16.71	14	499922.042	3929113.713	7.34
P5	499901.054	3929148.256	19.98	15	499917.739	3929107.767	11.75
7	499913.461	3929132.590	9.17	8	499910.899	3929098.209	
6	499919.080	3929125.345	8.48				



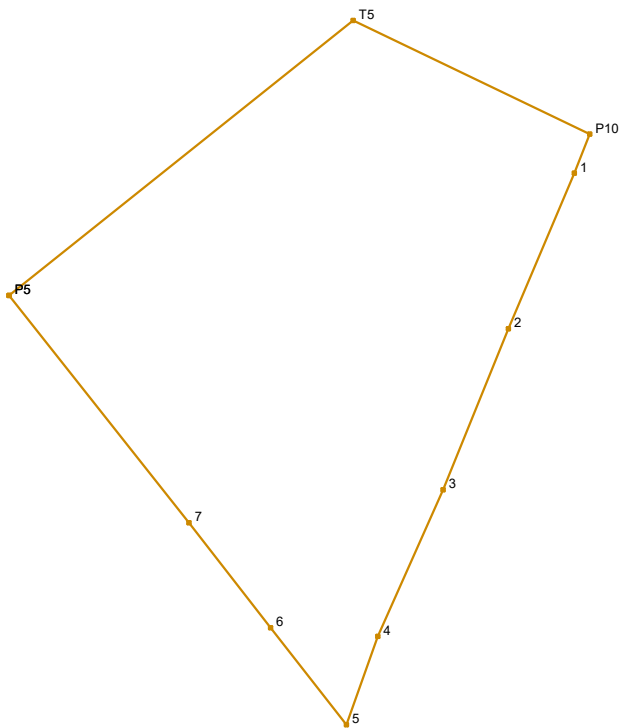

Νέα ιδιοκτησία εντός ΟΤ							
id1:1433		id2:06		Σημεία:10		Εμβαδό:964.32 m <sup>2</sup>	
Σημείο	X	Y	μήκος	Σημείο	X	Y	μήκος
P5	499901.054	3929148.256	30.37	4	499926.469	3929124.758	6.47
T5	499924.782	3929167.213		18.08	5	499924.302	3929118.661
P10	499941.069	3929159.372	2.89	6	499919.080	3929125.345	9.17
1	499940.019	3929156.680	11.65	7	499913.461	3929132.590	19.98
2	499935.472	3929145.955	11.97	P5	499901.054	3929148.256	
3	499930.982	3929134.854	11.06				

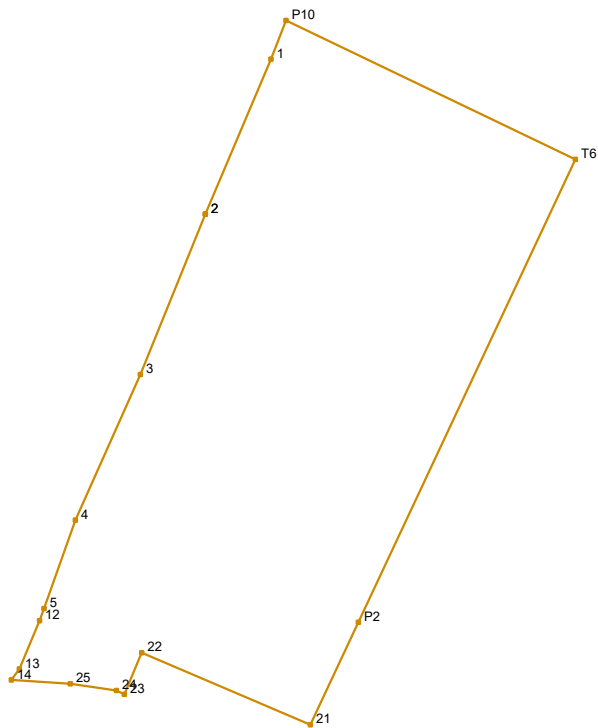

Νέα ιδιοκτησία εντός ΟΤ							
id1:1433		id2:07		Σημεία:16		Εμβαδό:957.42 m <sup>2</sup>	
Σημείο	X	Y	μήκος	Σημείο	X	Y	μήκος
2	499935.472	3929145.955	11.65	25	499926.114	3929113.436	4.08
1	499940.019	3929156.680	2.89	14	499922.042	3929113.713	0.94
P10	499941.069	3929159.372	22.22	13	499922.603	3929114.464	3.63
T6	499961.087	3929149.735	35.38	12	499924.001	3929117.813	0.90
P2	499946.072	3929117.696	7.83	5	499924.302	3929118.661	6.47
21	499942.749	3929110.606	12.69	4	499926.469	3929124.758	11.06
22	499931.073	3929115.583	3.10	3	499930.982	3929134.854	11.97
23	499929.879	3929112.721	0.61	2	499935.472	3929145.955	
24	499929.321	3929112.968	3.24				

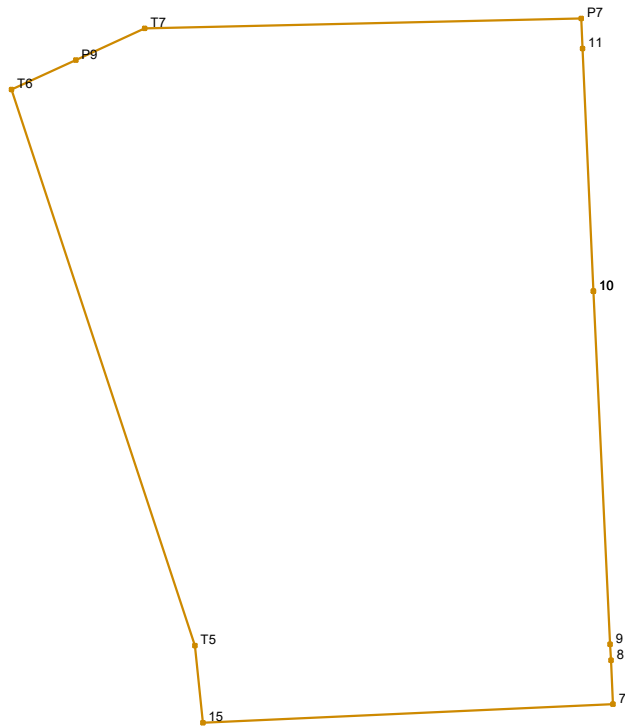

Νέα ιδιοκτησία εντός ΟΤ							
id1:1435		id2:01		Σημεία:11		Εμβαδό:600.00 m <sup>2</sup>	
Σημείο	X	Y	μήκος	Σημείο	X	Y	μήκος
10	499818.057	3929179.472	14.94	T6	499793.456	3929187.995	2.99
9	499818.761	3929164.551	0.68	P9	499796.172	3929189.242	3.20
8	499818.793	3929163.872	1.86	T7	499799.082	3929190.579	18.46
7	499818.880	3929162.017	17.36	P7	499817.536	3929191.010	1.28
15	499801.540	3929161.233	3.27	11	499817.595	3929189.733	10.27
T5	499801.208	3929164.490	24.75	10	499818.057	3929179.472	

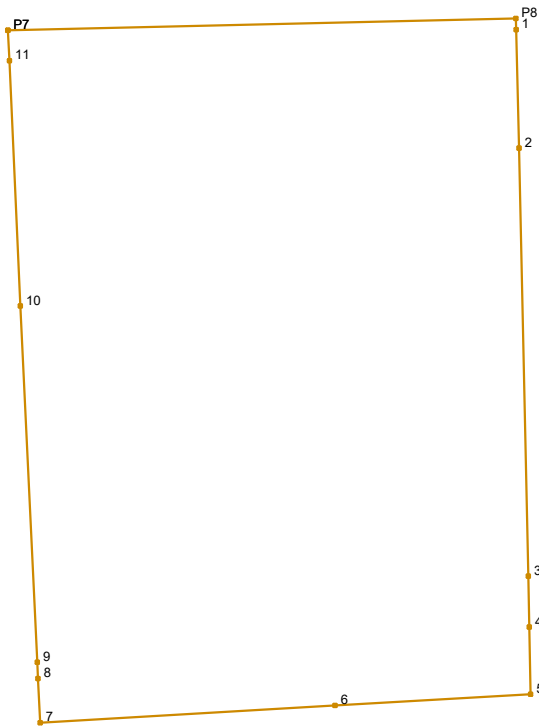

Νέα ιδιοκτησία εντός ΟΤ							
id1:1435		id2:02		Σημεία:13		Εμβαδό:600.00 m <sup>2</sup>	
Σημείο	X	Y	μήκος	Σημείο	X	Y	μήκος
P7	499817.536	3929191.010	21.27	6	499831.232	3929162.738	12.37
P8	499838.800	3929191.506		7	499818.880	3929162.017	1.86
1	499838.810	3929191.034	0.47	8	499818.793	3929163.872	0.68
2	499838.933	3929186.074	4.96	9	499818.761	3929164.551	14.94
3	499839.326	3929168.161	17.92	10	499818.057	3929179.472	10.27
4	499839.366	3929166.018	2.14	11	499817.595	3929189.733	1.28
5	499839.418	3929163.216	2.80	P7	499817.536	3929191.010	8.20
			8.20				

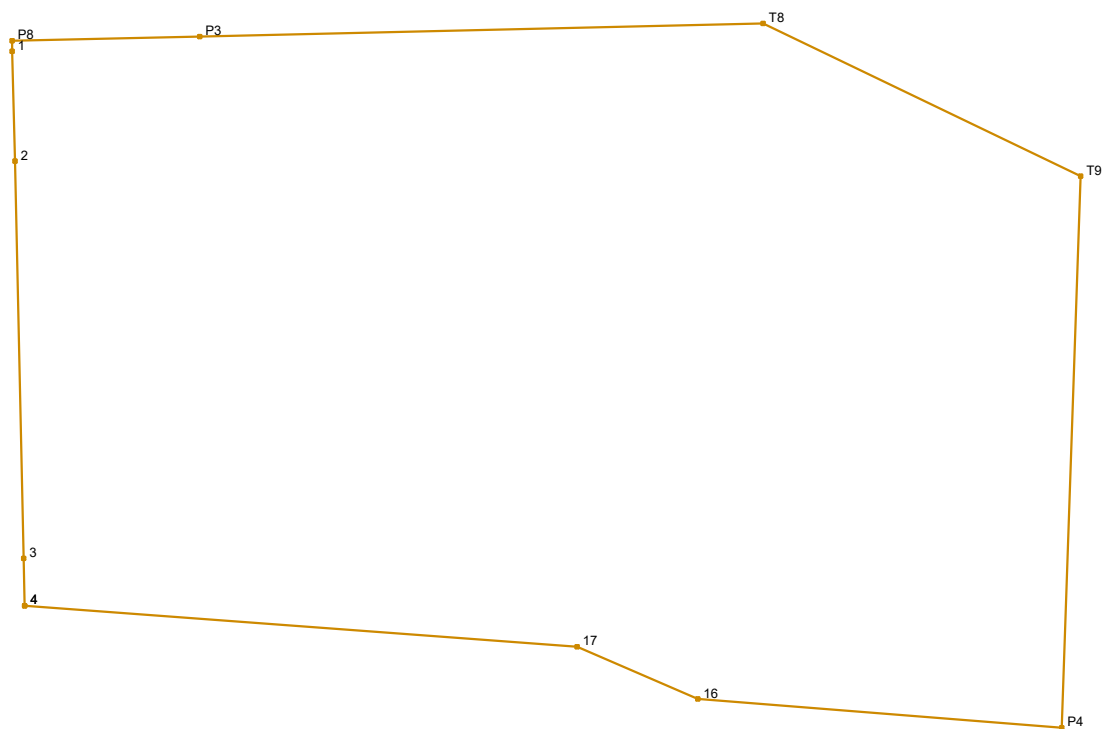

Νέα ιδιοκτησία εντός ΟΤ							
id1:1435		id2:03		Σημεία:11		Εμβαδό:1309.91 m <sup>2</sup>	
Σημείο	X	Y	μήκος	Σημείο	X	Y	μήκος
4	499839.366	3929166.018	2.14	T8	499872.679	3929192.296	15.90
3	499839.326	3929168.161	17.92	T9	499887.008	3929185.398	24.90
2	499838.933	3929186.074	4.96	P4	499886.154	3929160.517	16.47
1	499838.810	3929191.034	0.47	16	499869.732	3929161.810	5.92
P8	499838.800	3929191.506	8.47	17	499864.297	3929164.166	25.00
P3	499847.268	3929191.703	25.42	4	499839.366	3929166.018	

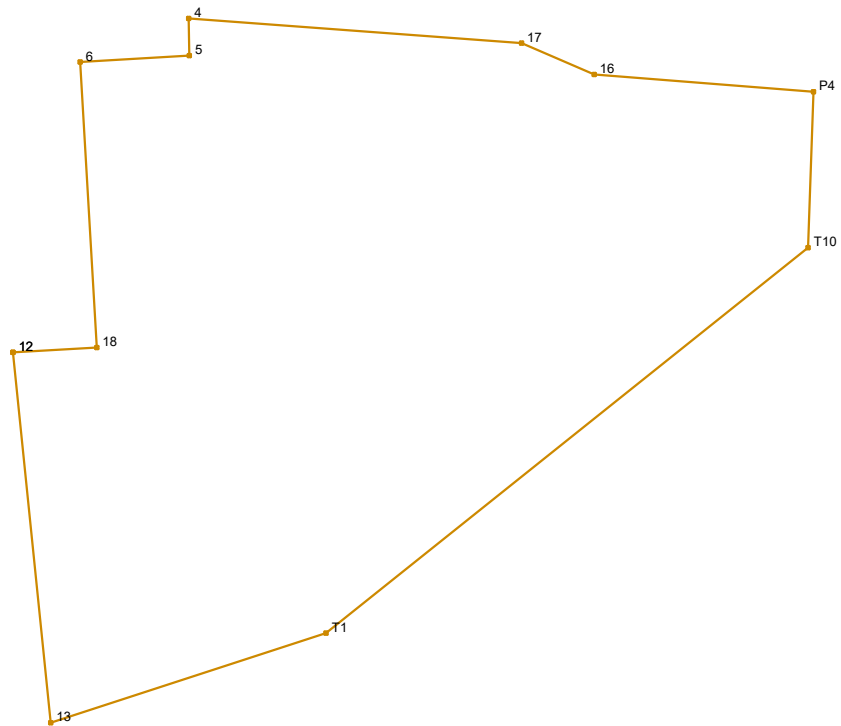

Νέα ιδιοκτησία εντός ΟΤ							
id1:1435		id2:04		Σημεία:11		Εμβαδό:1991.41 m <sup>2</sup>	
Σημείο	X	Y	μήκος	Σημείο	X	Y	μήκος
12	499826.208	3929140.994	6.28	16	499869.732	3929161.810	16.47
18	499832.479	3929141.359		P4	499886.154	3929160.517	11.69
6	499831.232	3929162.738	21.42	T10	499885.753	3929148.832	46.22
5	499839.418	3929163.216	8.20	T1	499849.644	3929119.985	21.68
4	499839.366	3929166.018	2.80	13	499829.026	3929113.268	27.87
17	499864.297	3929164.166	25.00	12	499826.208	3929140.994	
			5.92				

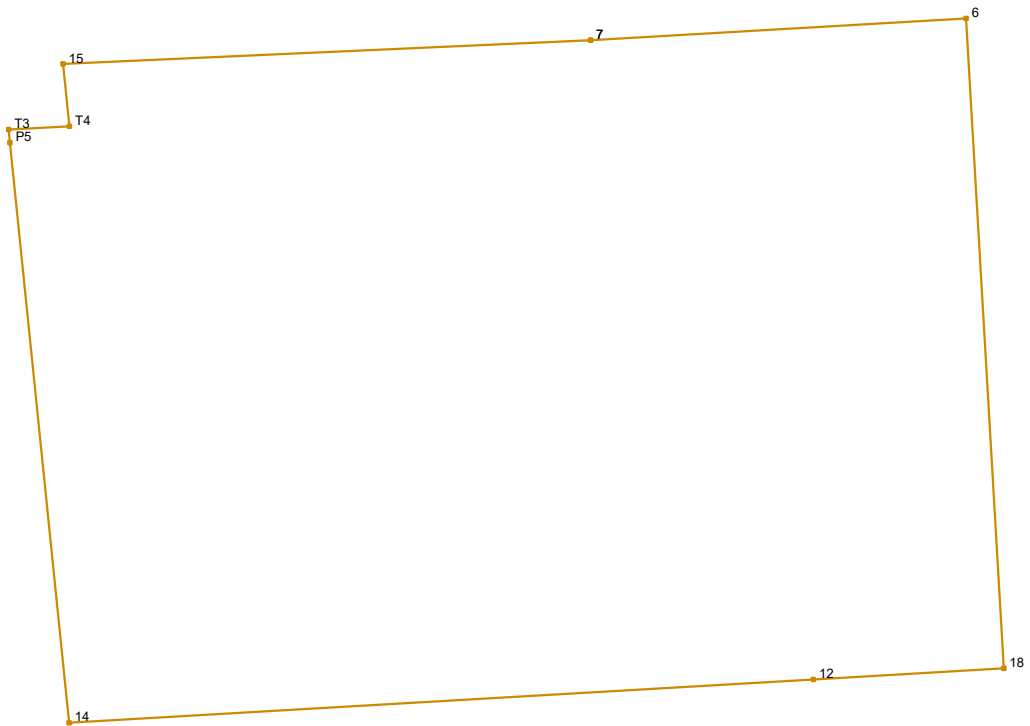

Νέα ιδιοκτησία εντός ΟΤ							
id1:1435		id2:05		Σημεία:9		Εμβαδό:667.68 m <sup>2</sup>	
Σημείο	X	Y	μήκος	Σημείο	X	Y	μήκος
7	499818.880	3929162.017	12.37	P5	499799.792	3929158.644	0.44
6	499831.232	3929162.738	21.42	T3	499799.748	3929159.082	2.00
18	499832.479	3929141.359	6.28	T4	499801.747	3929159.190	2.05
12	499826.208	3929140.994	24.52	15	499801.540	3929161.233	17.36
14	499801.731	3929139.572	19.17	7	499818.880	3929162.017	

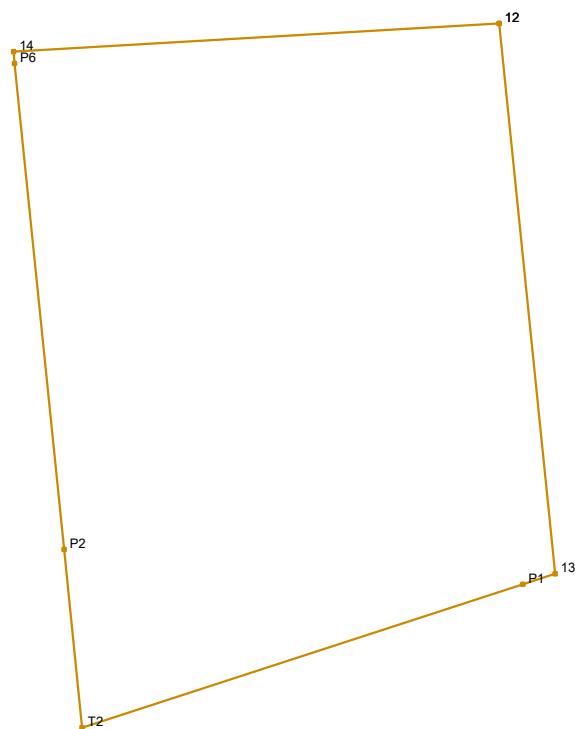

Νέα ιδιοκτησία εντός ΟΤ							
id1:1435		id2:06N		Σημεία:7		Εμβαδό:760.70 m <sup>2</sup>	
Σημείο	X	Y	μήκος	Σημείο	X	Y	μήκος
12	499826.208	3929140.994	27.87	P2	499804.281	3929114.491	24.60
13	499829.026	3929113.268		P6	499801.793	3929138.964	0.61
P1	499827.391	3929112.736	1.72	14	499801.731	3929139.572	24.52
T2	499805.195	3929105.505	23.34	12	499826.208	3929140.994	
			9.03				



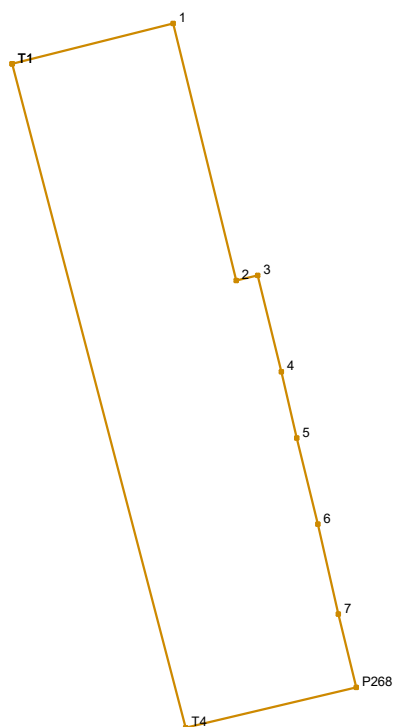

Νέα ιδιοκτησία εντός ΟΤ							
id1:1436		id2:01		Σημεία:10		Εμβαδό:362.25 m <sup>2</sup>	
Σημείο	X	Y	μήκος	Σημείο	X	Y	μήκος
T1	499832.734	3928911.290		6	499849.564	3928885.943	
			9.13				5.08
1	499841.588	3928913.528		7	499850.699	3928880.990	
			14.60				4.15
2	499845.078	3928899.355		P268	499851.685	3928876.960	
			1.20				9.66
3	499846.244	3928899.642		T4	499842.282	3928874.734	
			5.47				37.78
4	499847.551	3928894.331		T1	499832.734	3928911.290	
			3.74				
5	499848.409	3928890.688					
			4.88				

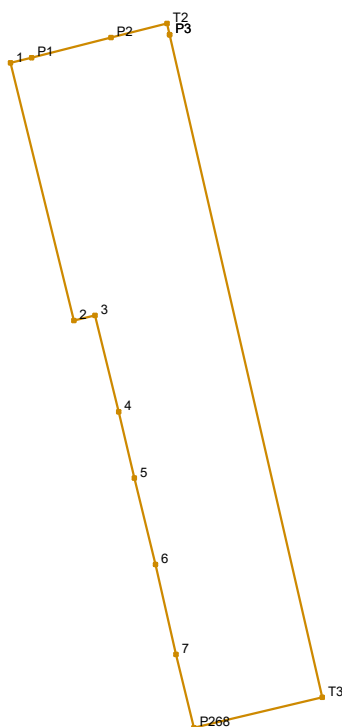

Νέα ιδιοκτησία εντός ΟΤ							
id1:1436		id2:02		Σημεία:13		Εμβαδό:300.00 m <sup>2</sup>	
Σημείο	X	Y	μήκος	Σημείο	X	Y	μήκος
P3	499850.354	3928915.077	37.40	3	499846.244	3928899.642	1.20
T3	499858.742	3928878.630		7.25	2	499845.078	3928899.355
P268	499851.685	3928876.960	4.15	1	499841.588	3928913.528	1.20
7	499850.699	3928880.990	5.08	P1	499842.752	3928913.823	4.50
6	499849.564	3928885.943	4.88	P2	499847.118	3928914.926	3.19
5	499848.409	3928890.688	3.74	T2	499850.209	3928915.707	0.65
4	499847.551	3928894.331	5.47	P3	499850.354	3928915.077	

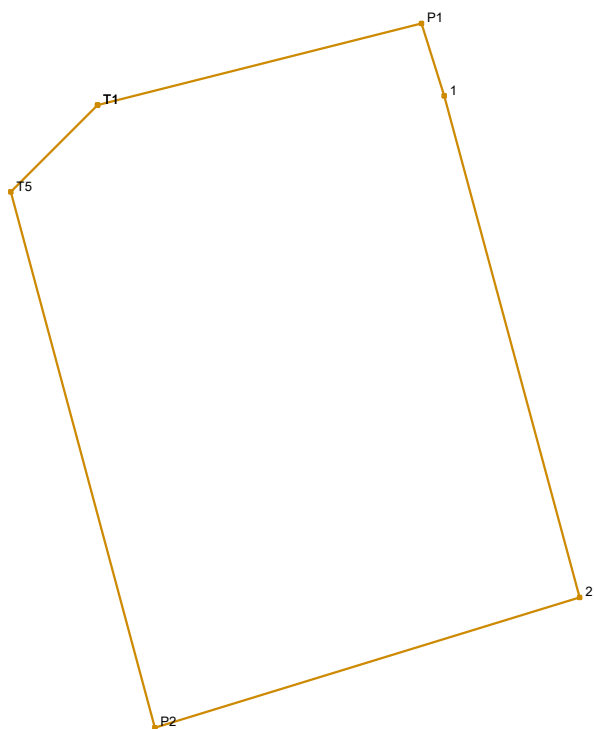

Νέα ιδιοκτησία εντός ΟΤ							
id1:1437		id2:01		Σημεία:6		Εμβαδό:223.22 m <sup>2</sup>	
Σημείο	X	Y	μήκος	Σημείο	X	Y	μήκος
T1	499799.315	3928908.001	9.69	P2	499800.971	3928889.957	16.09
P1	499808.708	3928910.375	2.20	T5	499796.803	3928905.493	3.55
1	499809.361	3928908.270	15.06	T1	499799.315	3928908.001	
2	499813.289	3928893.730	12.88				

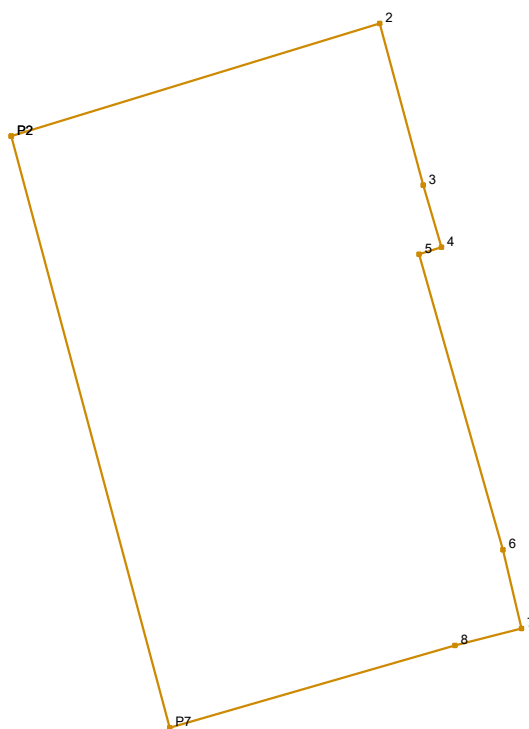

Νέα ιδιοκτησία εντός ΟΤ							
id1:1437		id2:02		Σημεία:9		Εμβαδό:256.86 m <sup>2</sup>	
Σημείο	X	Y	μήκος	Σημείο	X	Y	μήκος
P2	499800.971	3928889.957	12.88	6	499817.417	3928876.126	2.70
2	499813.289	3928893.730	5.60	7	499818.035	3928873.498	2.30
3	499814.750	3928888.324	2.17	8	499815.809	3928872.932	9.92
4	499815.357	3928886.244	0.78	P7	499806.277	3928870.180	20.48
5	499814.608	3928886.012	10.28	P2	499800.971	3928889.957	

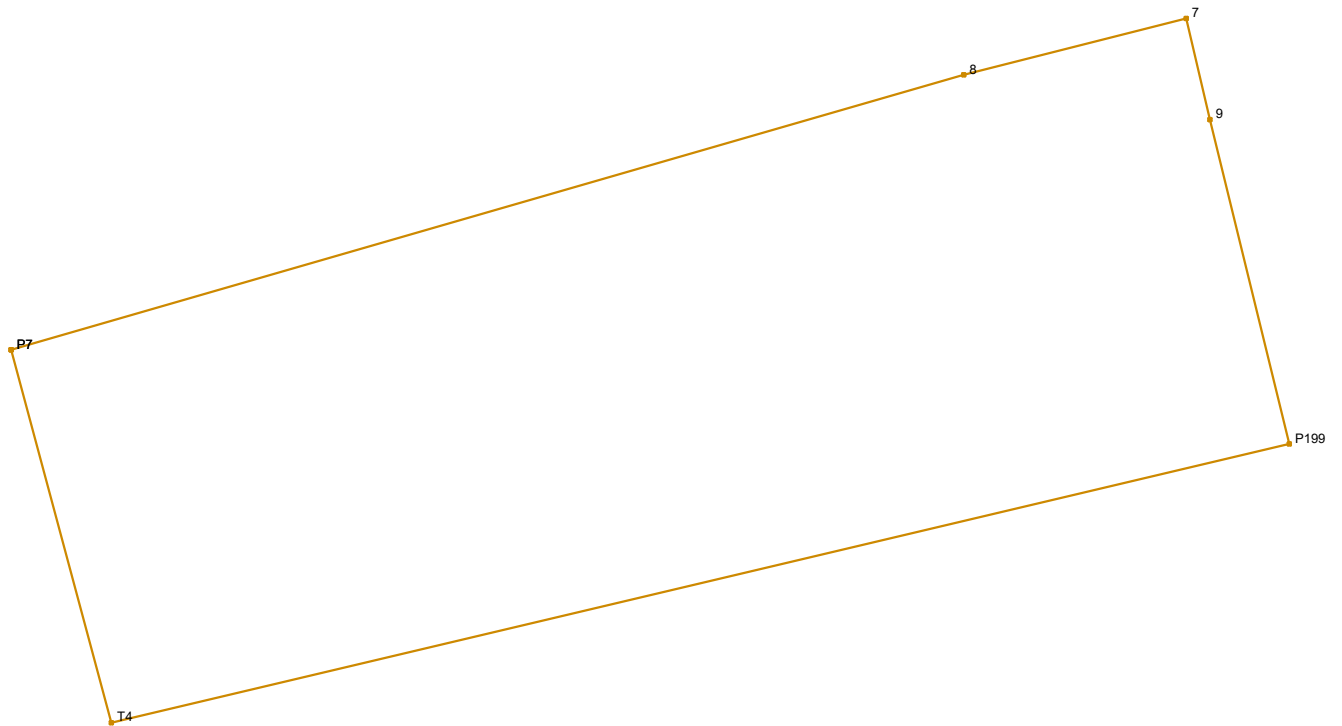

Νέα ιδιοκτησία εντός ΟΤ							
id1:1437		id2:03		Σημεία:6		Εμβαδό:50.49 m <sup>2</sup>	
Σημείο	X	Y	μήκος	Σημείο	X	Y	μήκος
P7	499806.277	3928870.180	9.92	P199	499819.069	3928869.240	12.12
8	499815.809	3928872.932		T4	499807.278	3928866.449	3.86
7	499818.035	3928873.498	2.30	P7	499806.277	3928870.180	
9	499818.274	3928872.484	1.04				
			3.34				

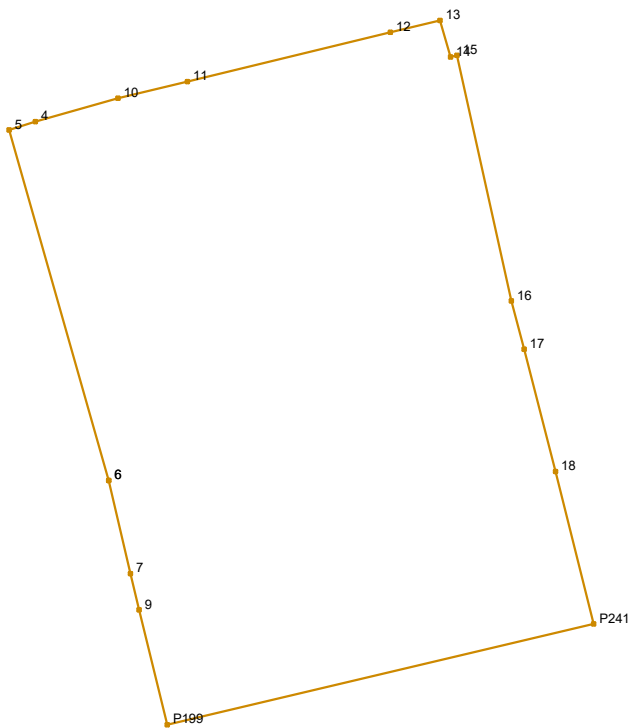

Νέα ιδιοκτησία εντός ΟΤ							
id1:1437		id2:04		Σημεία:16		Εμβαδό:217.49 m <sup>2</sup>	
Σημείο	X	Y	μήκος	Σημείο	X	Y	μήκος
6	499817.417	3928876.126		16	499828.774	3928881.190	1.41
5	499814.608	3928886.012	10.28	17	499829.141	3928879.826	3.56
4	499815.357	3928886.244	0.78	18	499830.023	3928876.380	4.43
10	499817.682	3928886.911	2.42	P241	499831.097	3928872.087	12.36
11	499819.638	3928887.374	2.01	P199	499819.069	3928869.240	3.34
12	499825.363	3928888.764	5.89	9	499818.274	3928872.484	1.04
13	499826.767	3928889.105	1.44	7	499818.035	3928873.498	2.70
14	499827.061	3928888.070	1.08	6	499817.417	3928876.126	
15	499827.246	3928888.116	0.19				
			7.09				

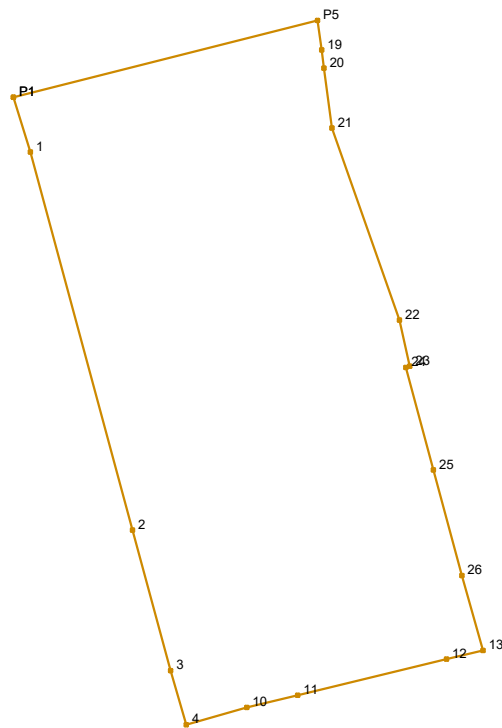

Νέα ιδιοκτησία εντός ΟΤ							
id1:1437		id2:05		Σημεία:18		Εμβαδό:294.12 m <sup>2</sup>	
Σημείο	X	Y	μήκος	Σημείο	X	Y	μήκος
P1	499808.708	3928910.375		13	499826.767	3928889.105	
			12.06				1.44
P5	499820.402	3928913.331		12	499825.363	3928888.764	
			1.15				5.89
19	499820.553	3928912.194		11	499819.638	3928887.374	
			0.71				2.01
20	499820.648	3928911.485		10	499817.682	3928886.911	
			2.31				2.42
21	499820.952	3928909.191		4	499815.357	3928886.244	
			7.83				2.17
22	499823.556	3928901.804		3	499814.750	3928888.324	
			1.81				5.60
23	499823.944	3928900.034		2	499813.289	3928893.730	
			0.15				15.06
24	499823.801	3928899.987		1	499809.361	3928908.270	
			4.09				2.20
25	499824.861	3928896.038		P1	499808.708	3928910.375	
			4.20				
26	499825.949	3928891.984					
			2.99				

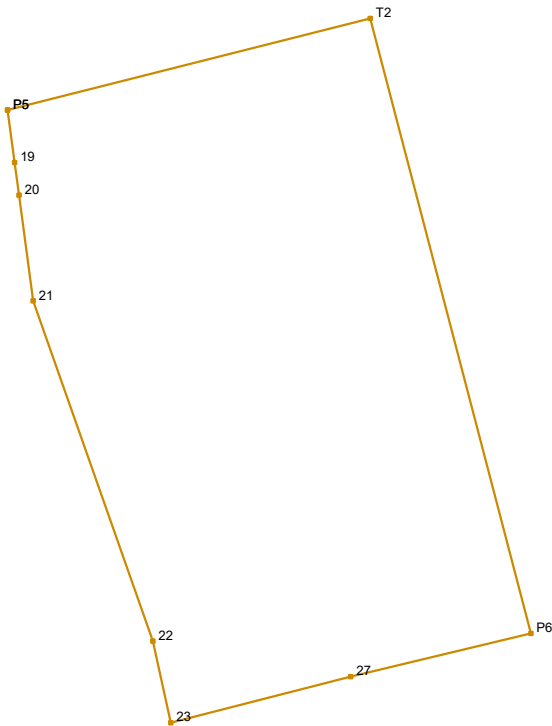

Νέα ιδιοκτησία εντός ΟΤ							
id1:1437		id2:06		Σημεία:9		Εμβαδό:114.03 m <sup>2</sup>	
Σημείο	X	Y	μήκος	Σημείο	X	Y	μήκος
P5	499820.402	3928913.331		22	499823.556	3928901.804	7.83
T2	499828.271	3928915.320	8.12	21	499820.952	3928909.191	2.31
P6	499831.757	3928901.971	13.80	20	499820.648	3928911.485	0.71
27	499827.845	3928901.036	4.02	19	499820.553	3928912.194	1.15
23	499823.944	3928900.034	4.03	P5	499820.402	3928913.331	
			1.81				



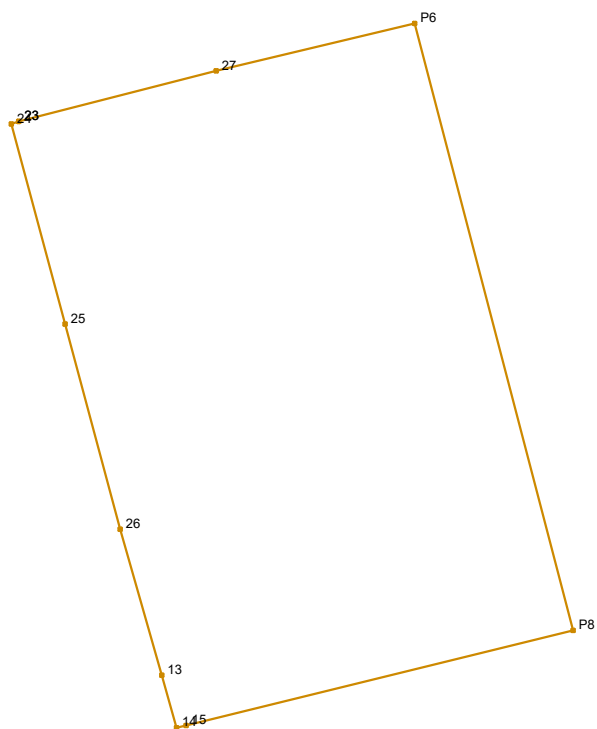

Νέα ιδιοκτησία εντός ΟΤ							
id1:1437		id2:07		Σημεία:10		Εμβαδό:100.95 m <sup>2</sup>	
Σημείο	X	Y	μήκος	Σημείο	X	Y	μήκος
23	499823.944	3928900.034	4.03	13	499826.767	3928889.105	2.99
27	499827.845	3928901.036		26	499825.949	3928891.984	4.20
P6	499831.757	3928901.971	12.38	25	499824.861	3928896.038	4.09
P8	499834.887	3928889.990		24	499823.801	3928899.987	
15	499827.246	3928888.116	7.87	23	499823.944	3928900.034	
14	499827.061	3928888.070	0.19				
			1.08				

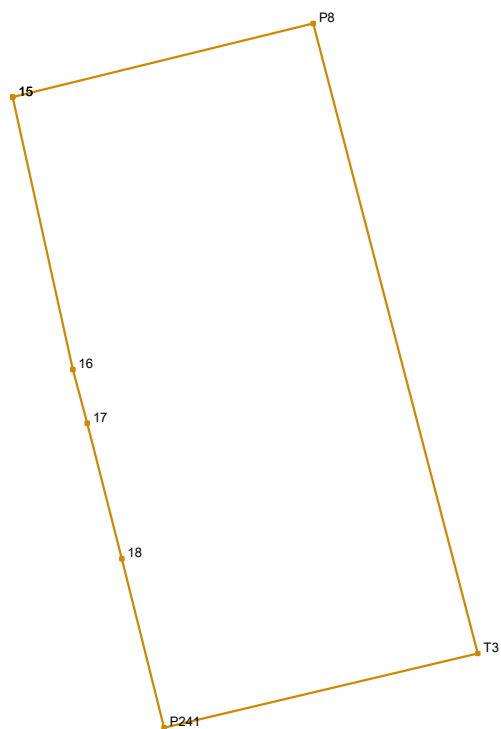

Νέα ιδιοκτησία εντός ΟΤ							
id1:1437		id2:08		Σημεία:7		Εμβαδό:133.60 m <sup>2</sup>	
Σημείο	X	Y	μήκος	Σημείο	X	Y	μήκος
15	499827.246	3928888.116	7.87	18	499830.023	3928876.380	3.56
P8	499834.887	3928889.990		16.55	17	499829.141	
T3	499839.070	3928873.974	8.19		16	499828.774	3928881.190
P241	499831.097	3928872.087		4.43	15	499827.246	3928888.116

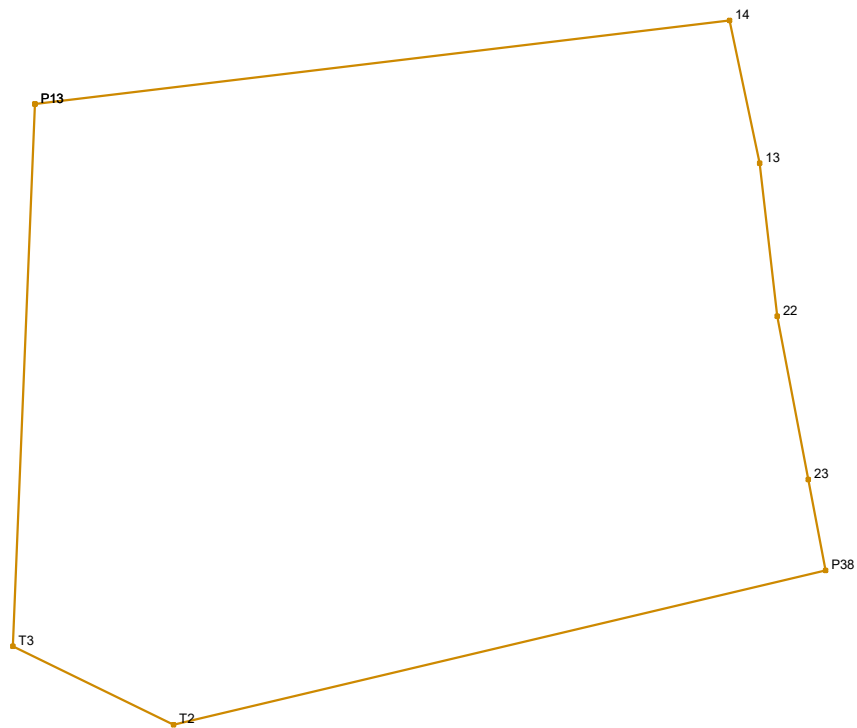

Νέα ιδιοκτησία εντός ΟΤ							
id1:1438		id2:01		Σημεία:8		Εμβαδό:296.43 m <sup>2</sup>	
Σημείο	X	Y	μήκος	Σημείο	X	Y	μήκος
P13	499721.677	3928862.912	17.91	P38	499741.918	3928850.978	17.15
14	499739.458	3928865.057	3.74	T2	499725.230	3928847.028	4.58
13	499740.229	3928861.399	3.94	T3	499721.117	3928849.032	13.89
22	499740.679	3928857.482	4.25	P13	499721.677	3928862.912	
23	499741.475	3928853.304	2.37				

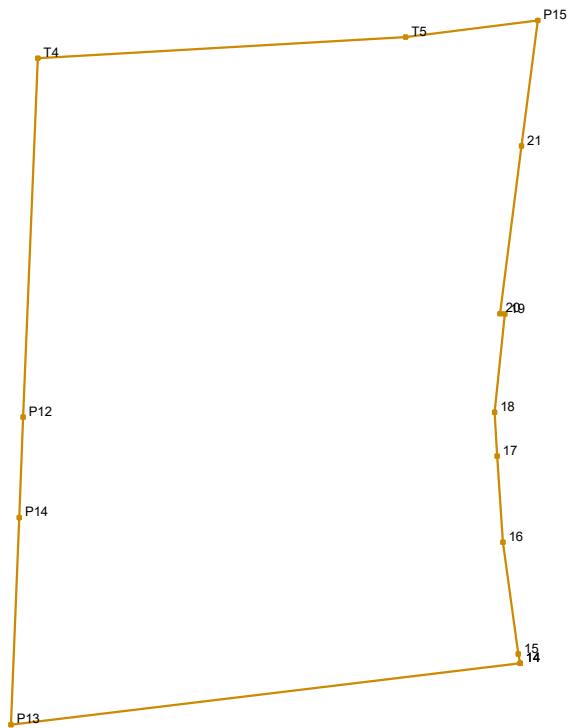

Νέα ιδιοκτησία εντός ΟΤ							
id1:1438		id2:02		Σημεία:14		Εμβαδό:384.68 m <sup>2</sup>	
Σημείο	X	Y	μήκος	Σημείο	X	Y	μήκος
14	499739.458	3928865.057		20	499738.756	3928877.263	
			17.91				0.16
P13	499721.677	3928862.912		19	499738.917	3928877.245	
			7.23				3.44
P14	499721.969	3928870.141		18	499738.567	3928873.823	
			3.52				1.54
P12	499722.110	3928873.655		17	499738.654	3928872.284	
			12.53				3.01
T4	499722.616	3928886.177		16	499738.859	3928869.279	
			12.87				3.93
T5	499735.462	3928886.912		15	499739.389	3928865.383	
			4.65				0.33
P15	499740.070	3928887.499		14	499739.458	3928865.057	
			4.42				
21	499739.507	3928883.111					
			5.90				

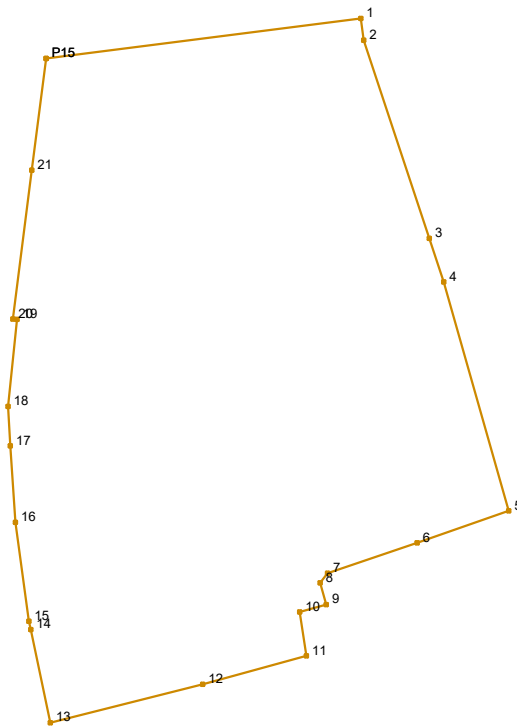

Νέα ιδιοκτησία εντός ΟΤ							
id1:1438		id2:03		Σημεία:22		Εμβαδό:392.18 m <sup>2</sup>	
Σημείο	X	Y	μήκος	Σημείο	X	Y	μήκος
P15	499740.070	3928887.499	12.47	12	499746.218	3928862.908	6.18
1	499752.436	3928889.077	0.86	13	499740.229	3928861.399	3.74
2	499752.546	3928888.220	8.20	14	499739.458	3928865.057	0.33
3	499755.129	3928880.433	1.80	15	499739.389	3928865.383	3.93
4	499755.692	3928878.720	9.35	16	499738.859	3928869.279	3.01
5	499758.240	3928869.721	3.80	17	499738.654	3928872.284	1.54
6	499754.646	3928868.474	3.72	18	499738.567	3928873.823	3.44
7	499751.120	3928867.279	0.48	19	499738.917	3928877.245	0.16
8	499750.831	3928866.894	0.89	20	499738.756	3928877.263	5.90
9	499751.071	3928866.035	1.08	21	499739.507	3928883.111	4.42
10	499750.025	3928865.746	1.74	P15	499740.070	3928887.499	
11	499750.292	3928864.030	4.23				

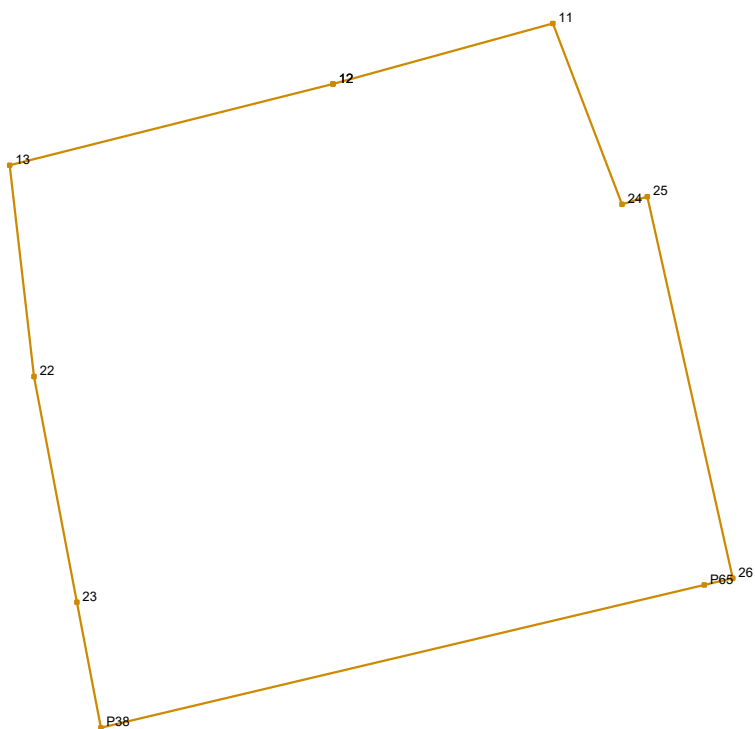

Νέα ιδιοκτησία εντός ΟΤ							
id1:1438		id2:04		Σημεία:10		Εμβαδό:122.91 m <sup>2</sup>	
Σημείο	X	Y	μήκος	Σημείο	X	Y	μήκος
12	499746.218	3928862.908	4.23	P38	499741.918	3928850.978	2.37
11	499750.292	3928864.030	3.59	23	499741.475	3928853.304	4.25
24	499751.575	3928860.675	0.49	22	499740.679	3928857.482	3.94
25	499752.043	3928860.821	7.25	13	499740.229	3928861.399	6.18
26	499753.628	3928853.750	0.54	12	499746.218	3928862.908	
P65	499753.099	3928853.625	11.49				

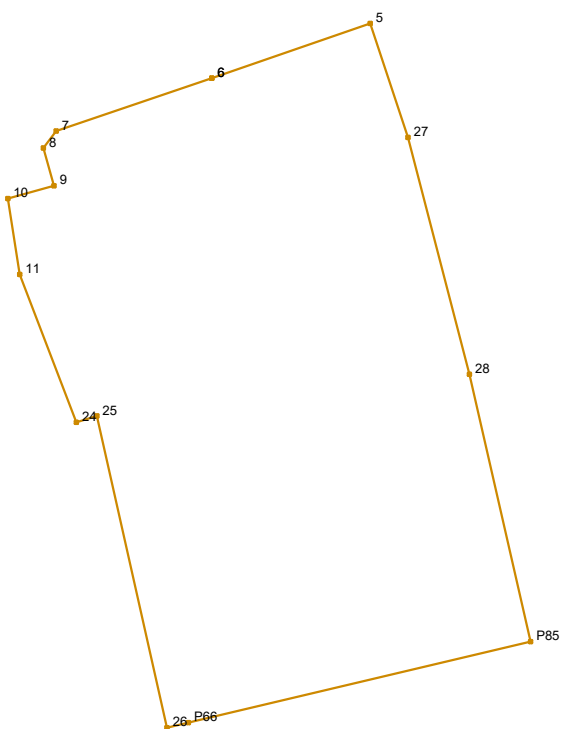

Νέα ιδιοκτησία εντός ΟΤ							
id1:1438		id2:05		Σημεία:14		Εμβαδό:121.93 m <sup>2</sup>	
Σημείο	X	Y	μήκος	Σημείο	X	Y	μήκος
6	499754.646	3928868.474		24	499751.575	3928860.675	
			3.80				3.59
5	499758.240	3928869.721		11	499750.292	3928864.030	
			2.72				1.74
27	499759.098	3928867.136		10	499750.025	3928865.746	
			5.55				1.08
28	499760.490	3928861.760		9	499751.071	3928866.035	
			6.21				0.89
P85	499761.876	3928855.702		8	499750.831	3928866.894	
			7.98				0.48
P66	499754.115	3928853.865		7	499751.120	3928867.279	
			0.50				3.72
26	499753.628	3928853.750		6	499754.646	3928868.474	
			7.25				
25	499752.043	3928860.821					
			0.49				

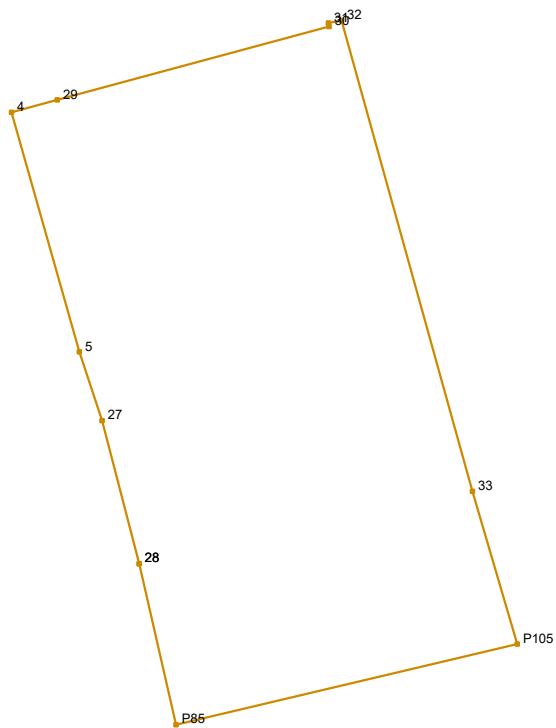

Νέα ιδιοκτησία εντός ΟΤ							
id1:1438		id2:06		Σημεία:11		Εμβαδό:308.99 m <sup>2</sup>	
Σημείο	X	Y	μήκος	Σημείο	X	Y	μήκος
28	499760.490	3928861.760		31	499767.604	3928882.070	
			5.55				0.50
27	499759.098	3928867.136		32	499768.095	3928882.177	
			2.72				18.38
5	499758.240	3928869.721		33	499773.014	3928864.469	
			9.35				5.97
4	499755.692	3928878.720		P105	499774.700	3928858.738	
			1.78				13.18
29	499757.413	3928879.185		P85	499761.876	3928855.702	
			10.58				6.21
30	499767.632	3928881.943		28	499760.490	3928861.760	
			0.13				



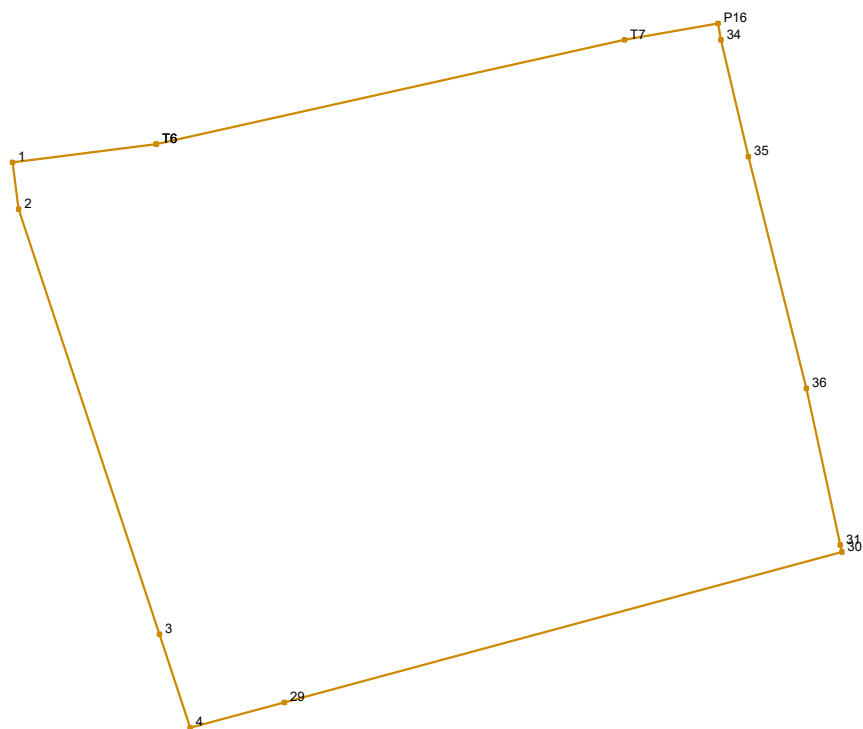

Νέα ιδιοκτησία εντός ΟΤ							
id1:1438		id2:07		Σημεία:13		Εμβαδό:132.61 m <sup>2</sup>	
Σημείο	X	Y	μήκος	Σημείο	X	Y	μήκος
T6	499755.068	3928889.413	8.79	30	499767.632	3928881.943	10.58
T7	499763.649	3928891.324	1.74	29	499757.413	3928879.185	1.78
P16	499765.361	3928891.626	0.31	4	499755.692	3928878.720	1.80
34	499765.414	3928891.323	2.20	3	499755.129	3928880.433	8.20
35	499765.916	3928889.182	4.38	2	499752.546	3928888.220	0.86
36	499766.981	3928884.935	2.93	1	499752.436	3928889.077	2.65
31	499767.604	3928882.070	0.13	T6	499755.068	3928889.413	

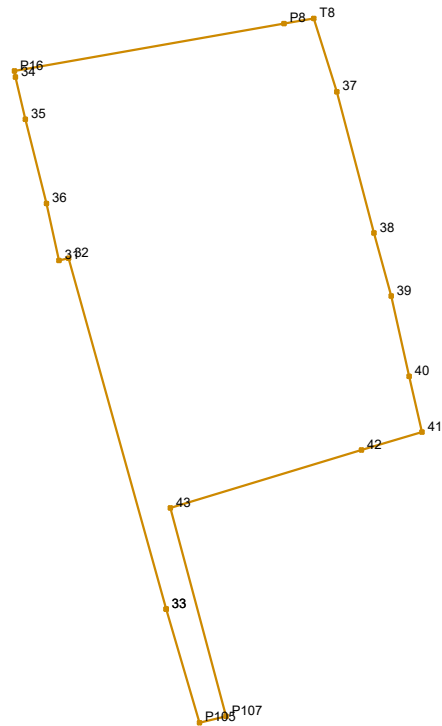

Νέα ιδιοκτησία εντός ΟΤ							
id1:1438		id2:08		Σημεία:18		Εμβαδό:359.54 m <sup>2</sup>	
Σημείο	X	Y	μήκος	Σημείο	X	Y	μήκος
33	499773.014	3928864.469	18.38	38	499783.501	3928883.451	3.29
32	499768.095	3928882.177	0.50	39	499784.371	3928880.280	4.17
31	499767.604	3928882.070	2.93	40	499785.285	3928876.211	2.88
36	499766.981	3928884.935	4.38	41	499785.933	3928873.406	3.19
35	499765.916	3928889.182	2.20	42	499782.871	3928872.495	10.07
34	499765.414	3928891.323	0.31	43	499773.230	3928869.580	10.89
P16	499765.361	3928891.626	13.82	P107	499776.044	3928859.056	1.38
P8	499778.970	3928894.022	1.52	P105	499774.700	3928858.738	5.97
T8	499780.471	3928894.286	3.89	33	499773.014	3928864.469	
37	499781.630	3928890.572	7.36				

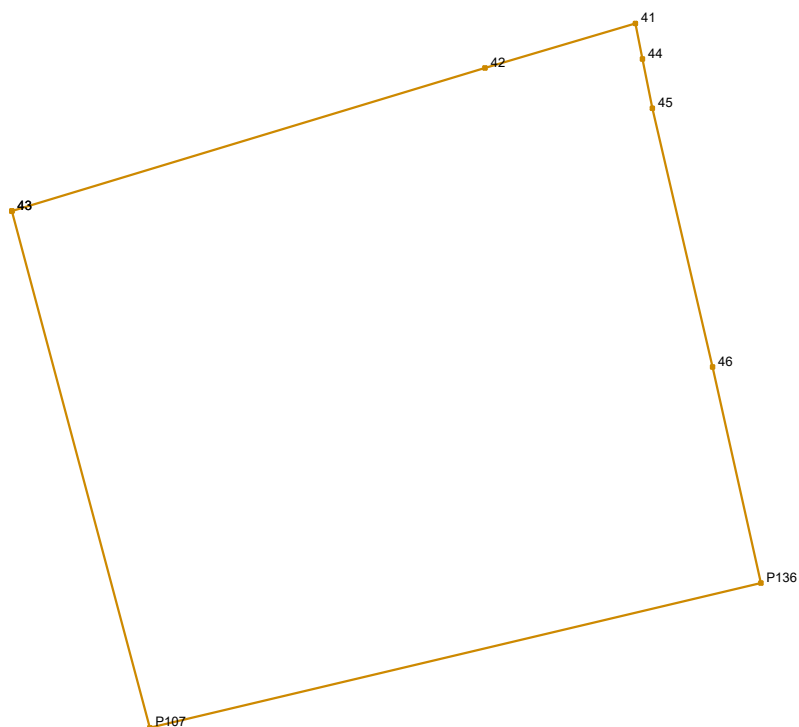

Νέα ιδιοκτησία εντός ΟΤ							
id1:1438		id2:09		Σημεία:8		Εμβαδό:146.91 m <sup>2</sup>	
Σημείο	X	Y	μήκος	Σημείο	X	Y	μήκος
43	499773.230	3928869.580	10.07	46	499787.505	3928866.407	4.51
42	499782.871	3928872.495		P136	499788.491	3928862.002	
41	499785.933	3928873.406	3.19	P107	499776.044	3928859.056	12.79
44	499786.079	3928872.679	0.74	43	499773.230	3928869.580	10.89
45	499786.282	3928871.674	1.03				
			5.41				

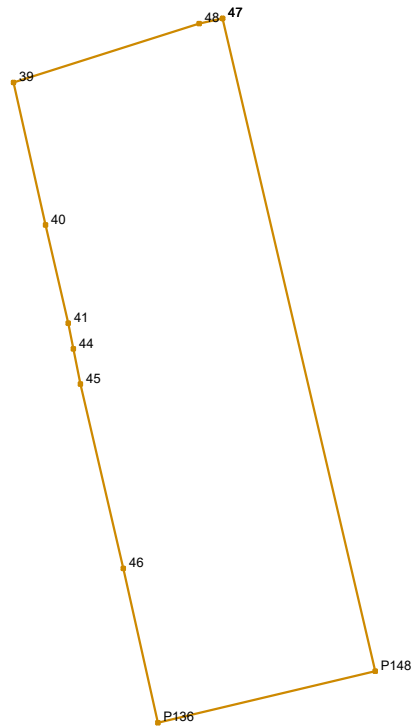

Νέα ιδιοκτησία εντός ΟΤ							
id1:1438		id2:10		Σημεία:10		Εμβαδό:119.51 m <sup>2</sup>	
Σημείο	X	Y	μήκος	Σημείο	X	Y	μήκος
47	499790.338	3928882.109	19.14	41	499785.933	3928873.406	2.88
P148	499794.693	3928863.470		40	499785.285	3928876.211	4.17
P136	499788.491	3928862.002	6.37	39	499784.371	3928880.280	5.56
46	499787.505	3928866.407	4.51	48	499789.674	3928881.960	0.68
			5.41	47	499790.338	3928882.109	
45	499786.282	3928871.674	1.03				
44	499786.079	3928872.679	0.74				

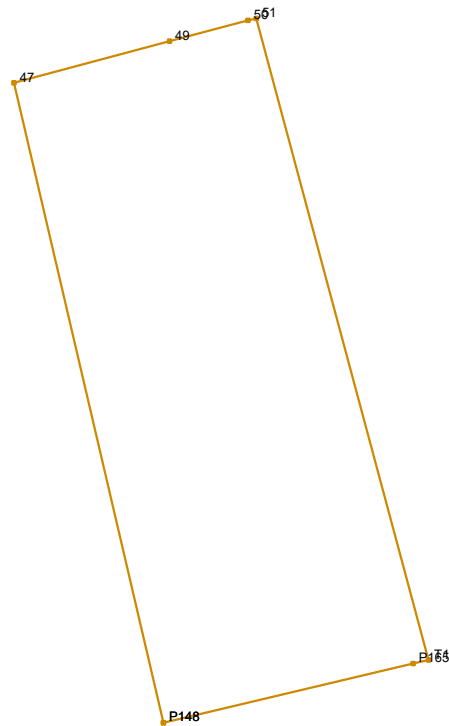

Νέα ιδιοκτησία εντός ΟΤ							
id1:1438		id2:11		Σημεία:7		Εμβαδό:146.58 m <sup>2</sup>	
Σημείο	X	Y	μήκος	Σημείο	X	Y	μήκος
P148	499794.693	3928863.470		51	499797.397	3928883.985	
			19.14				19.35
47	499790.338	3928882.109		T1	499802.410	3928865.297	
			4.69				0.46
49	499794.870	3928883.321		P165	499801.962	3928865.191	
			2.36				7.47
50	499797.154	3928883.921		P148	499794.693	3928863.470	
			0.25				

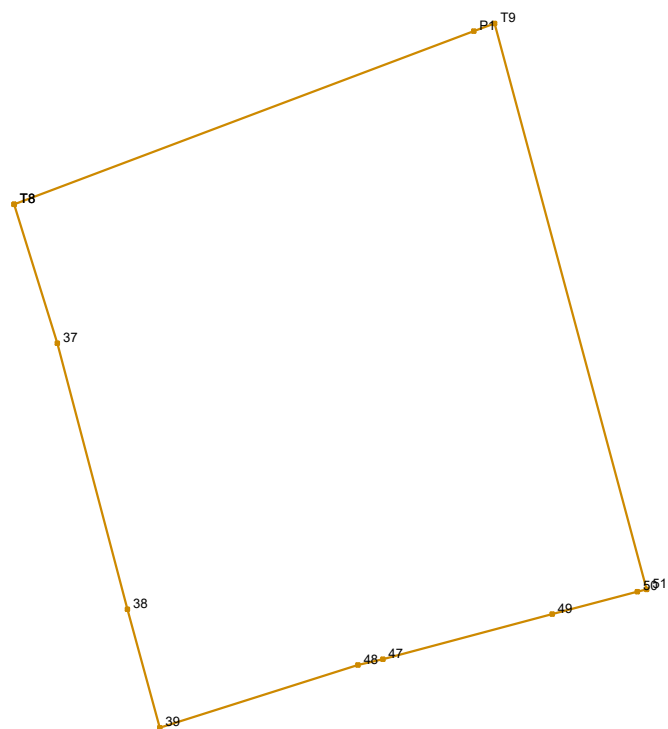

Νέα ιδιοκτησία εντός ΟΤ							
id1:1438		id2:12		Σημεία:11		Εμβαδό:203.91 m <sup>2</sup>	
Σημείο	X	Y	μήκος	Σημείο	X	Y	μήκος
T8	499780.471	3928894.286		47	499790.338	3928882.109	
			13.15				0.68
P1	499792.778	3928898.924		48	499789.674	3928881.960	
			0.59				5.56
T9	499793.333	3928899.133		39	499784.371	3928880.280	
			15.68				3.29
51	499797.397	3928883.985		38	499783.501	3928883.451	
			0.25				7.36
50	499797.154	3928883.921		37	499781.630	3928890.572	
			2.36				3.89
49	499794.870	3928883.321		T8	499780.471	3928894.286	
			4.69				

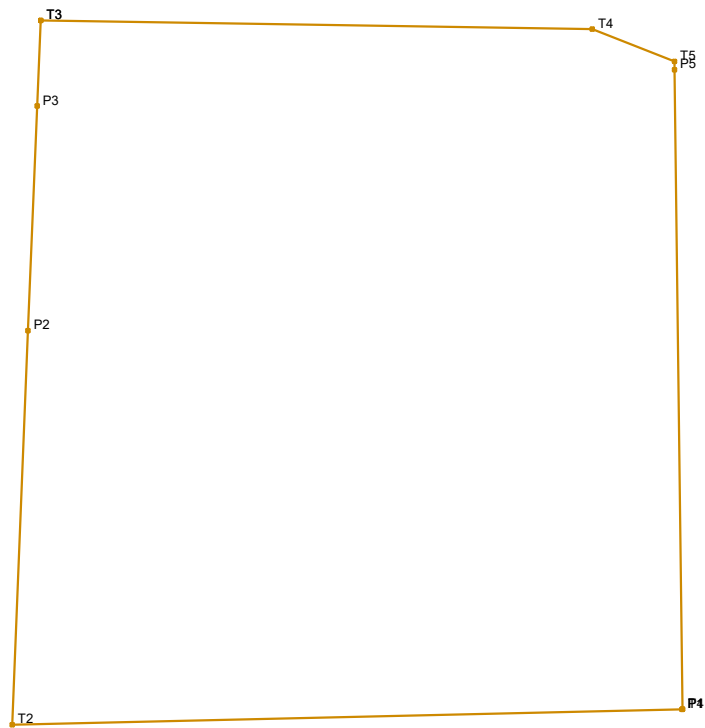

Νέα ιδιοκτησία εντός ΟΤ							
id1:1439		id2:01		Σημεία:10		Εμβαδό:247.25 m <sup>2</sup>	
Σημείο	X	Y	μήκος	Σημείο	X	Y	μήκος
T3	499723.454	3928906.948	12.94	P1	499738.495	3928890.791	15.71
T4	499736.394	3928906.740		T2	499722.787	3928890.429	
T5	499738.320	3928905.981	2.07	P2	499723.160	3928899.667	9.25
P5	499738.322	3928905.789	0.19	P3	499723.373	3928904.938	5.27
P4	499738.508	3928890.793	15.00	T3	499723.454	3928906.948	2.01
T1	499738.508	3928890.791	0.00				
			0.01				

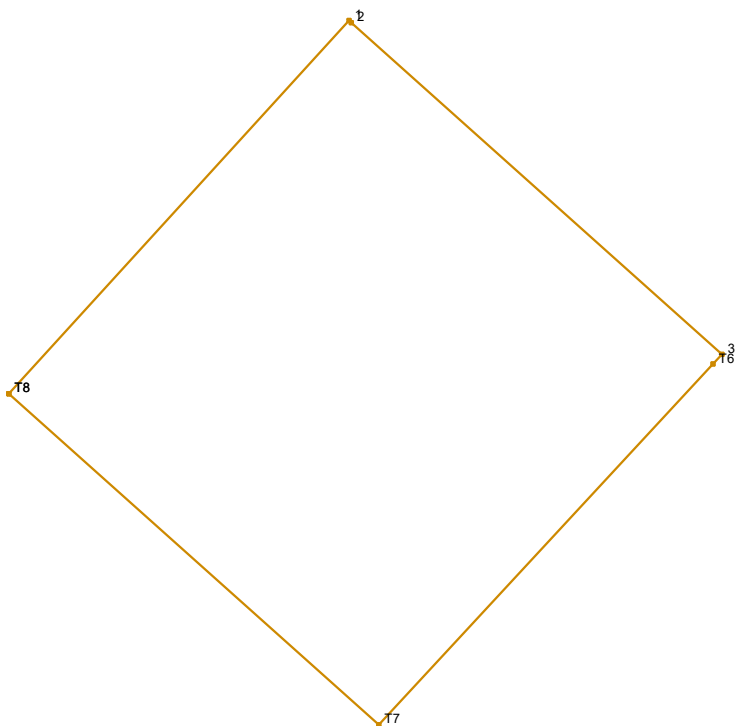

Νέα ιδιοκτησία εντός ΟΤ							
id1:1440		id2:01		Σημεία:6		Εμβαδό:72.43 m <sup>2</sup>	
Σημείο	X	Y	μήκος	Σημείο	X	Y	μήκος
T8	499760.946	3928909.869	8.57	T6	499772.889	3928910.371	8.34
1	499766.716	3928916.202		T7	499767.221	3928904.253	
2	499766.759	3928916.164	0.06	T8	499760.946	3928909.869	8.42
3	499773.041	3928910.535	8.44				
			0.22				



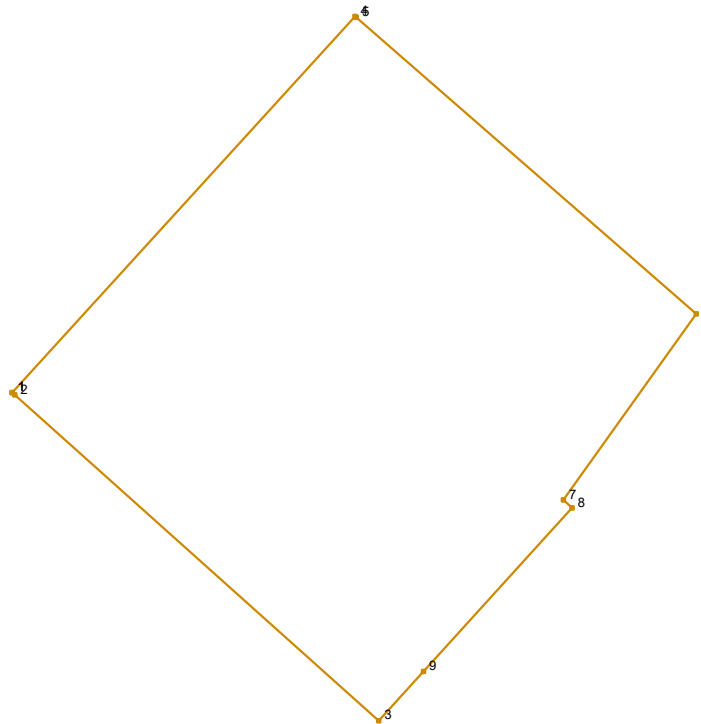

Νέα ιδιοκτησία εντός ΟΤ							
id1:1440		id2:02		Σημεία:9		Εμβαδό:73.36 m <sup>2</sup>	
Σημείο	X	Y	μήκος	Σημείο	X	Y	μήκος
1	499766.716	3928916.202	8.79	8	499776.382	3928914.210	3.81
4	499772.635	3928922.697	0.03	9	499773.817	3928911.388	1.15
5	499772.658	3928922.677	7.79	3	499773.041	3928910.535	8.44
6	499778.529	3928917.562	3.95	2	499766.759	3928916.164	0.06
7	499776.231	3928914.348	0.20	1	499766.716	3928916.202	

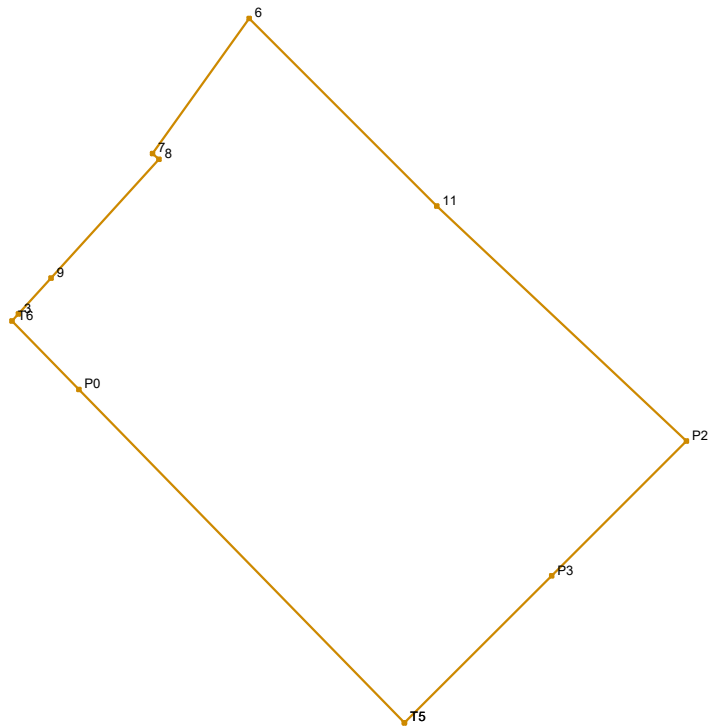

Νέα ιδιοκτησία εντός ΟΤ							
id1:1440		id2:03		Σημεία:11		Εμβαδό:126.76 m <sup>2</sup>	
Σημείο	X	Y	μήκος	Σημείο	X	Y	μήκος
T5	499782.214	3928900.822		7	499776.231	3928914.348	
			11.07				3.95
P0	499774.481	3928908.741		6	499778.529	3928917.562	
			2.28				6.31
T6	499772.889	3928910.371		11	499782.983	3928913.097	
			0.22				8.15
3	499773.041	3928910.535		P2	499788.920	3928907.515	
			1.15				4.53
9	499773.817	3928911.388		P3	499785.715	3928904.316	
			3.81				4.95
8	499776.382	3928914.210		T5	499782.214	3928900.822	
			0.20				

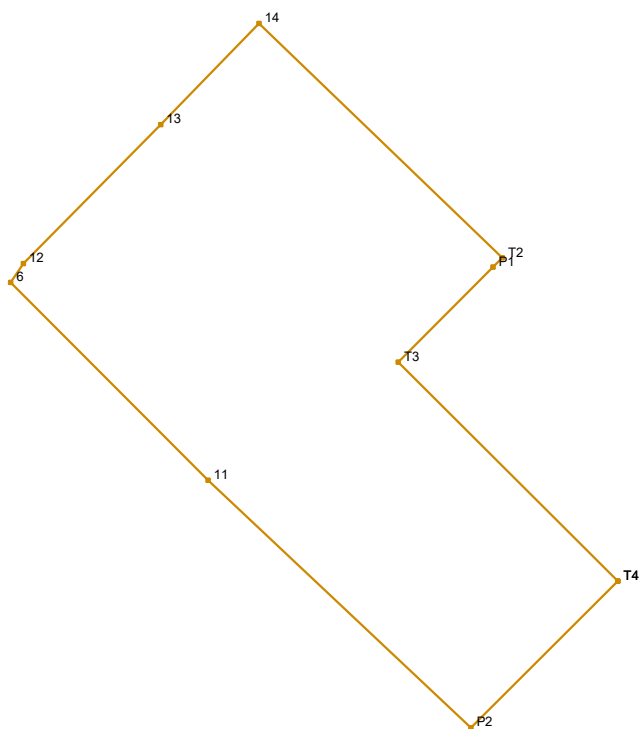

Νέα ιδιοκτησία εντός ΟΤ							
id1:1440		id2:04		Σημεία:10		Εμβαδό:95.46 m <sup>2</sup>	
Σημείο	X	Y	μήκος	Σημείο	X	Y	μήκος
T4	499792.238	3928910.827		14	499784.136	3928923.414	
			4.69				7.62
P2	499788.920	3928907.515		T2	499789.626	3928918.125	
			8.15				0.30
11	499782.983	3928913.097		P1	499789.415	3928917.913	
			6.31				3.03
6	499778.529	3928917.562		T3	499787.277	3928915.766	
			0.51				7.00
12	499778.815	3928917.989		T4	499792.238	3928910.827	
			4.41				
13	499781.918	3928921.130					
			3.18				

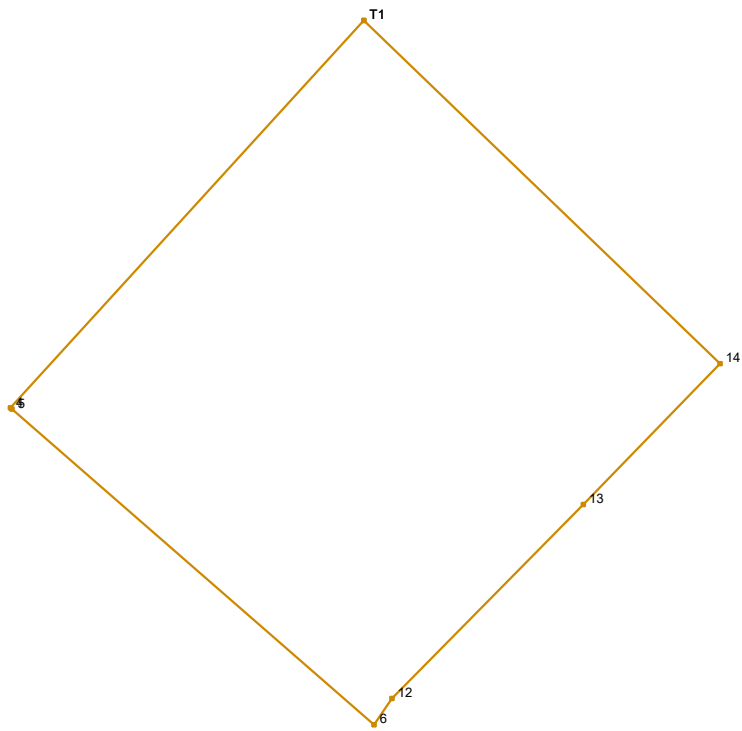

Νέα ιδιοκτησία εντός ΟΤ							
id1:1440		id2:05		Σημεία:7		Εμβαδό:65.41 m <sup>2</sup>	
Σημείο	X	Y	μήκος	Σημείο	X	Y	μήκος
T1	499778.359	3928928.979	8.02	6	499778.529	3928917.562	7.79
14	499784.136	3928923.414	3.18	5	499772.658	3928922.677	0.03
13	499781.918	3928921.130	4.41	4	499772.635	3928922.697	8.50
12	499778.815	3928917.989	0.51	T1	499778.359	3928928.979	

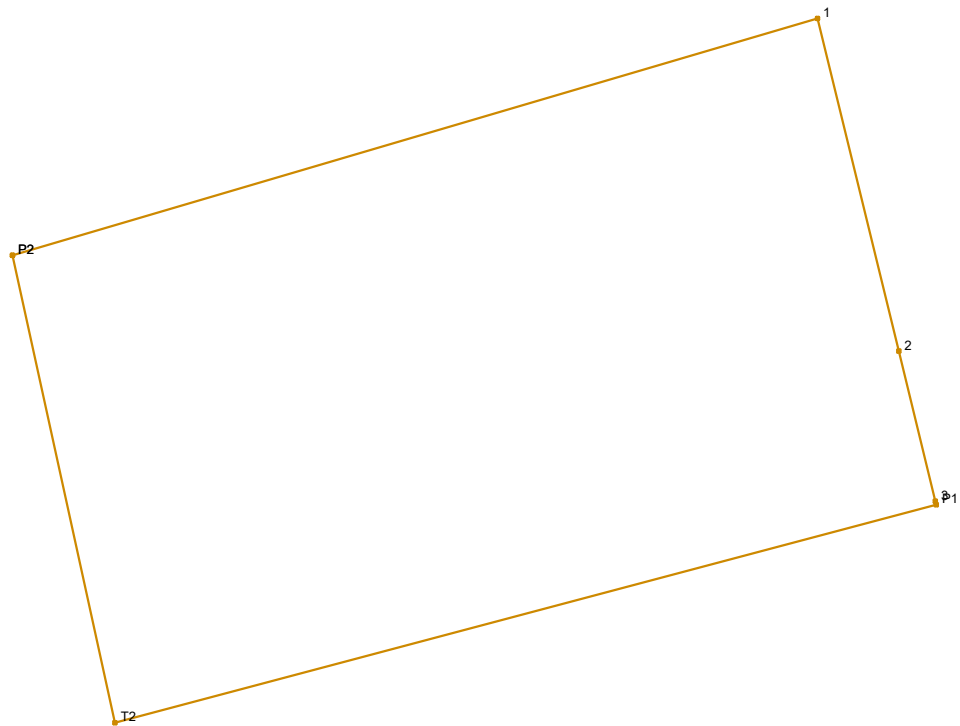

Νέα ιδιοκτησία εντός ΟΤ							
id1:1443		id2:01		Σημεία:6		Εμβαδό:270.22 m <sup>2</sup>	
Σημείο	X	Y	μήκος	Σημείο	X	Y	μήκος
P2	499808.643	3929011.839	21.47	P1	499832.275	3929005.460	21.73
1	499829.236	3929017.899		8.76	T2	499811.269	
2	499831.316	3929009.385	3.95	P2	499808.643	3929011.839	
3	499832.254	3929005.548	0.09				

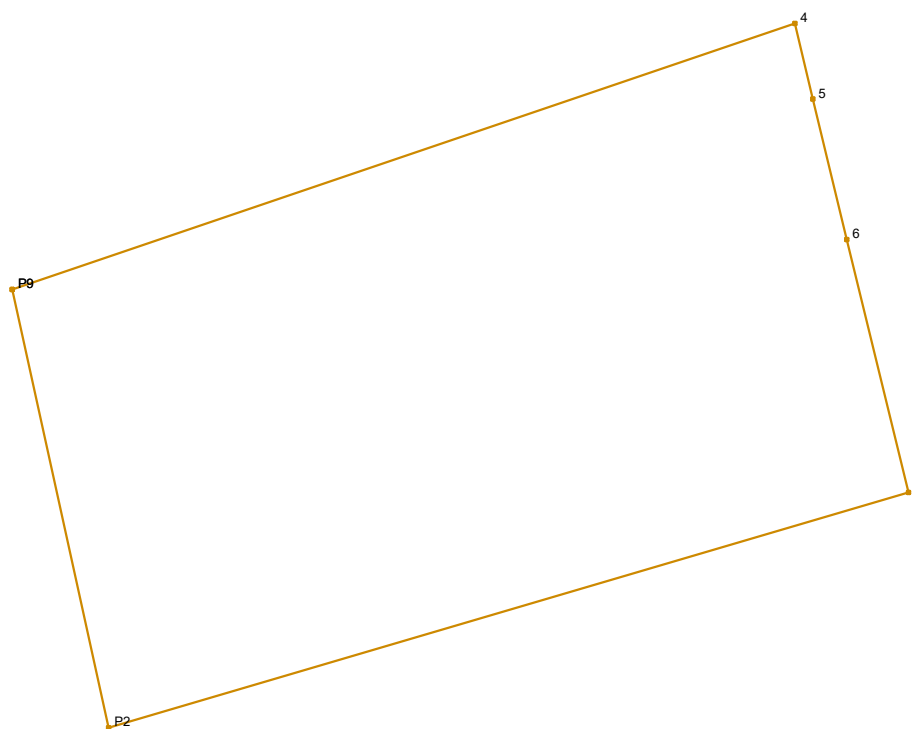

Νέα ιδιοκτησία εντός ΟΤ							
id1:1443		id2:02		Σημεία:6		Εμβαδό:255.21 m <sup>2</sup>	
Σημείο	X	Y	μήκος	Σημείο	X	Y	μήκος
P9	499806.164	3929023.121	21.28	1	499829.236	3929017.899	21.47
4	499826.309	3929029.971		P2	499808.643	3929011.839	11.55
5	499826.778	3929028.019	2.01	P9	499806.164	3929023.121	
6	499827.647	3929024.402	3.72				
			6.69				

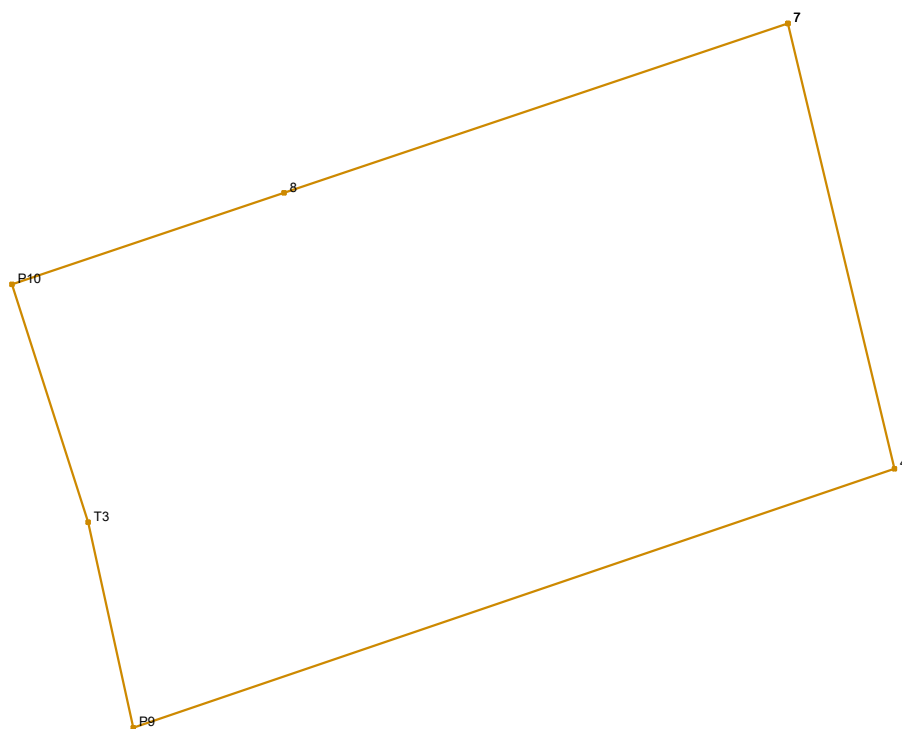

Νέα ιδιοκτησία εντός ΟΤ							
id1:1443		id2:03		Σημεία:6		Εμβαδό:258.18 m <sup>2</sup>	
Σημείο	X	Y	μήκος	Σημείο	X	Y	μήκος
7	499823.485	3929041.758	12.12	P10	499802.960	3929034.855	7.59
4	499826.309	3929029.971		21.28	8	499810.158	3929037.276
P9	499806.164	3929023.121	5.57	7	499823.485	3929041.758	
T3	499804.969	3929028.562	6.61				

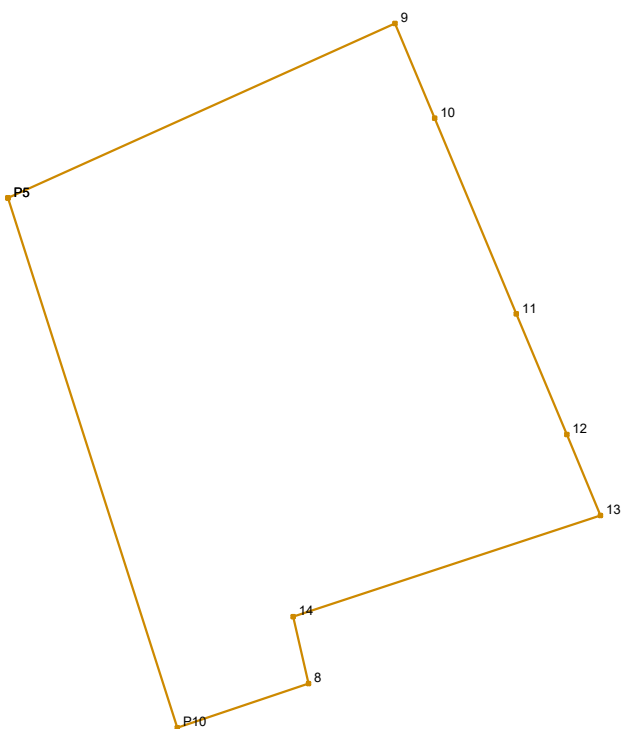

Νέα ιδιοκτησία εντός ΟΤ							
id1:1443		id2:04		Σημεία:9		Εμβαδό:712.27 m <sup>2</sup>	
Σημείο	X	Y	μήκος	Σημείο	X	Y	μήκος
P5	499793.678	3929063.916	23.28	13	499826.175	3929046.487	17.75
9	499814.896	3929073.484		5.64	14	499809.314	3929040.940
10	499817.071	3929068.282	11.62	8	499810.158	3929037.276	7.59
11	499821.553	3929057.559	7.18	P10	499802.960	3929034.855	30.51
12	499824.318	3929050.935	4.82	P5	499793.678	3929063.916	



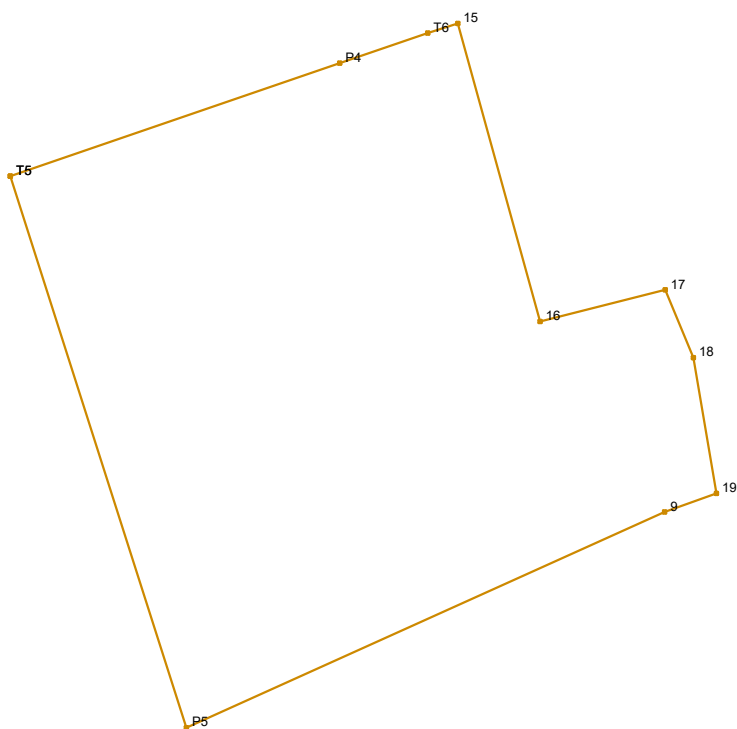

Νέα ιδιοκτησία εντός ΟΤ							
id1:1443		id2:05		Σημεία:10		Εμβαδό:563.22 m <sup>2</sup>	
Σημείο	X	Y	μήκος	Σημείο	X	Y	μήκος
T5	499785.864	3929088.381	15.45	18	499816.173	3929080.331	6.10
P4	499800.480	3929093.387		4.12	19	499817.187	
T6	499804.378	3929094.722	1.42	9	499814.896	3929073.484	23.28
15	499805.725	3929095.161	13.71	P5	499793.678	3929063.916	25.68
16	499809.371	3929081.941	5.72	T5	499785.864	3929088.381	
17	499814.919	3929083.333	3.25				

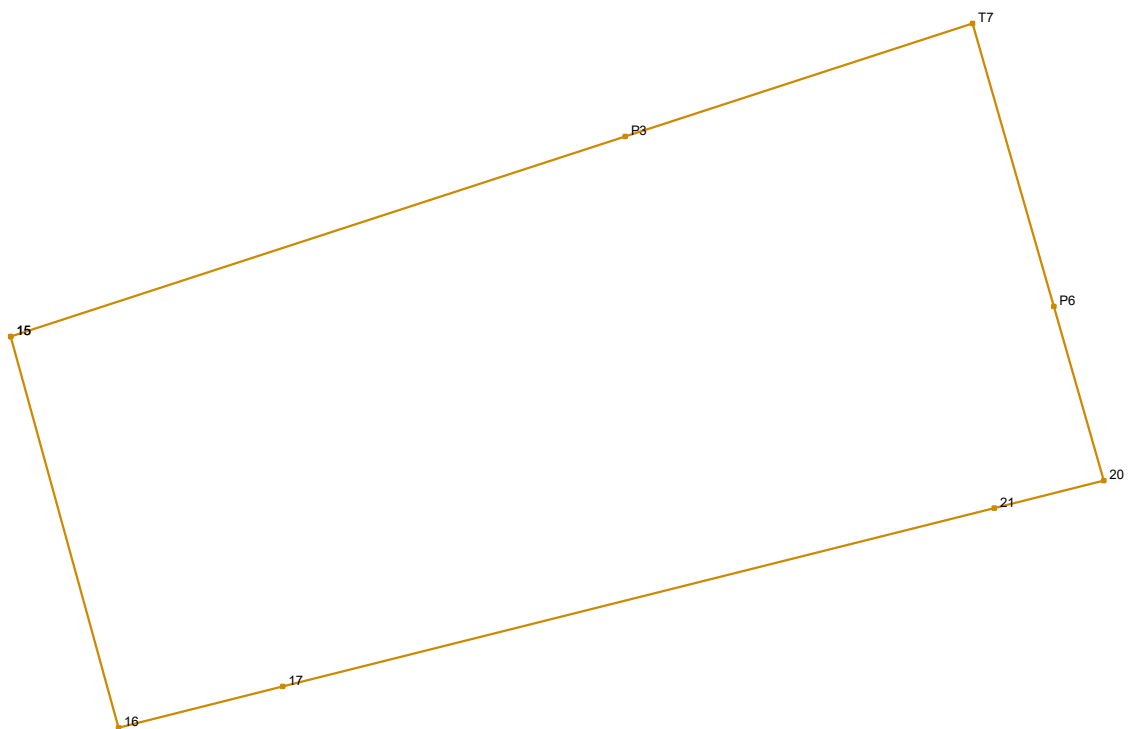

Νέα ιδιοκτησία εντός ΟΤ							
id1:1443		id2:06		Σημεία:8		Εμβαδό:510.14 m <sup>2</sup>	
Σημείο	X	Y	μήκος	Σημείο	X	Y	μήκος
15	499805.725	3929095.161	21.84	21	499838.972	3929089.365	24.80
P3	499826.492	3929101.926	12.35	17	499814.919	3929083.333	5.72
T7	499838.239	3929105.752	9.96	16	499809.371	3929081.941	13.71
P6	499840.985	3929096.180	6.12	15	499805.725	3929095.161	
20	499842.674	3929090.293	3.82				

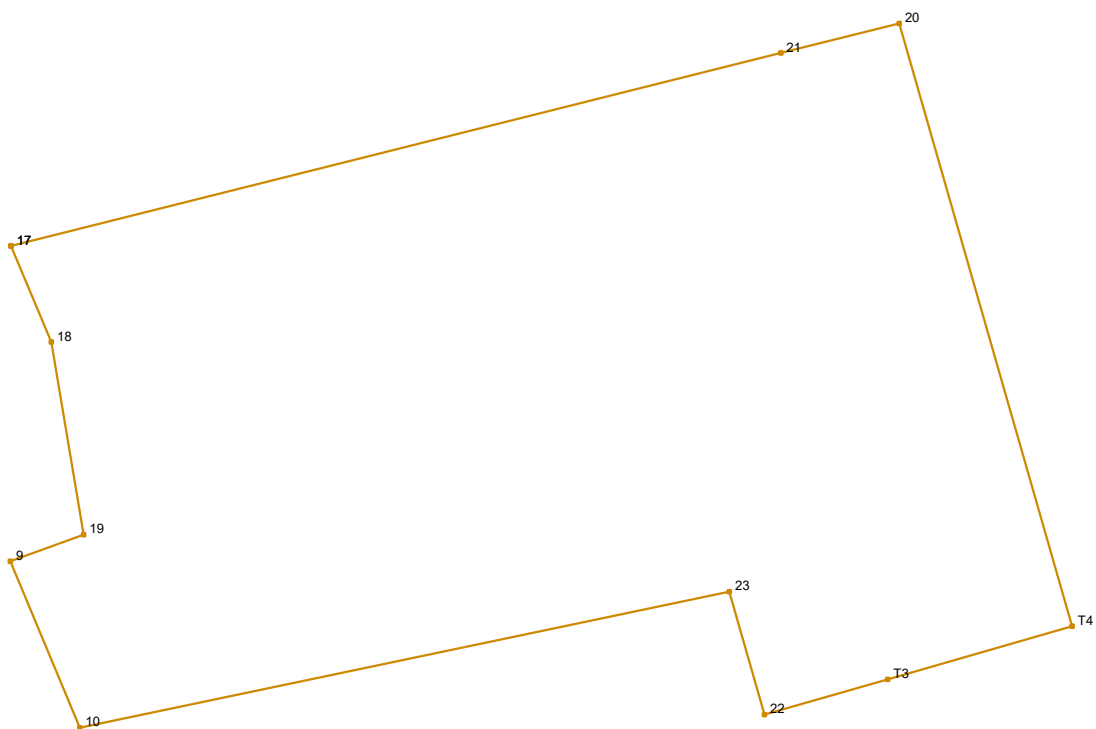

Νέα ιδιοκτησία εντός ΟΤ							
id1:1443		id2:07		Σημεία:11		Εμβαδό:500.50 m <sup>2</sup>	
Σημείο	X	Y	μήκος	Σημείο	X	Y	μήκος
17	499814.919	3929083.333	24.80	23	499837.364	3929072.537	20.73
21	499838.972	3929089.365	3.82	10	499817.071	3929068.282	5.64
20	499842.674	3929090.293	19.60	9	499814.896	3929073.484	2.44
T4	499848.079	3929071.449	6.00	19	499817.187	3929074.314	6.10
T3	499842.312	3929069.795	4.00	18	499816.173	3929080.331	3.25
22	499838.467	3929068.692	4.00	17	499814.919	3929083.333	

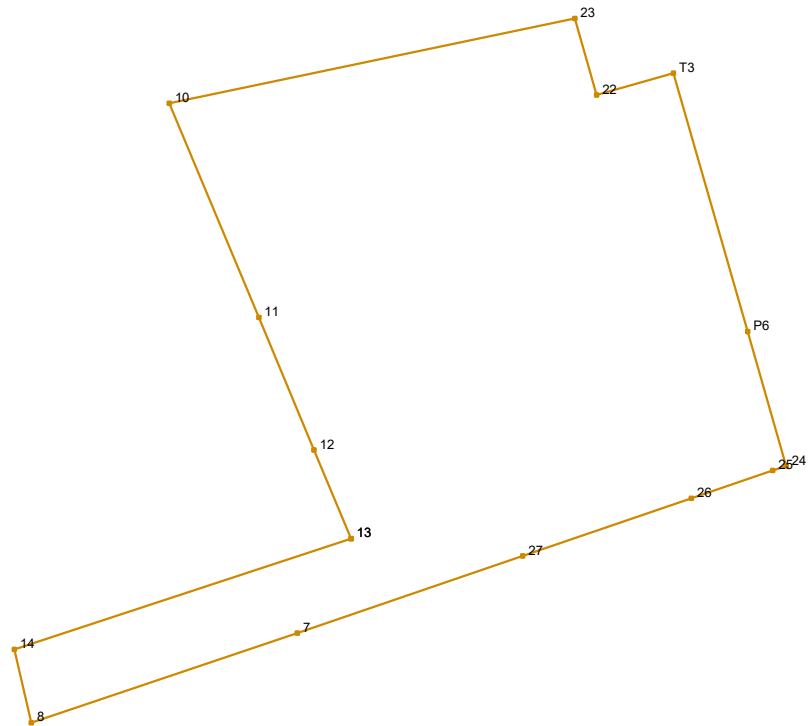

Νέα ιδιοκτησία εντός ΟΤ							
id1:1443		id2:08		Σημεία:15		Εμβαδό:641.89 m <sup>2</sup>	
Σημείο	X	Y	μήκος	Σημείο	X	Y	μήκος
13	499826.175	3929046.487		24	499847.952	3929050.131	
			4.82	25	499847.279	3929049.902	0.71
12	499824.318	3929050.935		26	499843.195	3929048.513	4.31
			7.18	27	499834.766	3929045.617	8.91
11	499821.553	3929057.559		7	499823.485	3929041.758	11.92
			11.62	8	499810.158	3929037.276	14.06
10	499817.071	3929068.282		14	499809.314	3929040.940	17.75
			20.73	13	499826.175	3929046.487	
23	499837.364	3929072.537					
			4.00				
22	499838.467	3929068.692					
			4.00				
T3	499842.312	3929069.795					
			13.46				
P6	499846.024	3929056.854					
			6.99				

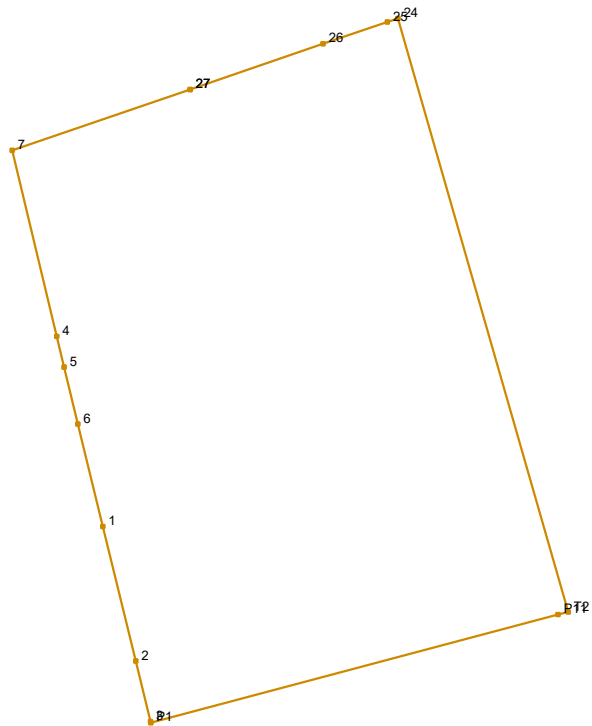

Νέα ιδιοκτησία εντός ΟΤ							
id1:1443		id2:09		Σημεία:14		Εμβαδό:1017.89 m <sup>2</sup>	
Σημείο	X	Y	μήκος	Σημείο	X	Y	μήκος
27	499834.766	3929045.617		2	499831.316	3929009.385	
			8.91				8.76
26	499843.195	3929048.513		1	499829.236	3929017.899	
			4.31				6.69
25	499847.279	3929049.902		6	499827.647	3929024.402	
			0.71				3.72
24	499847.952	3929050.131		5	499826.778	3929028.019	
			39.16				2.01
T2	499858.749	3929012.490		4	499826.309	3929029.971	
			0.69				12.12
P11	499858.086	3929012.314		7	499823.485	3929041.758	
			26.70				11.92
P1	499832.275	3929005.460		27	499834.766	3929045.617	
			0.09				
3	499832.254	3929005.548					
			3.95				

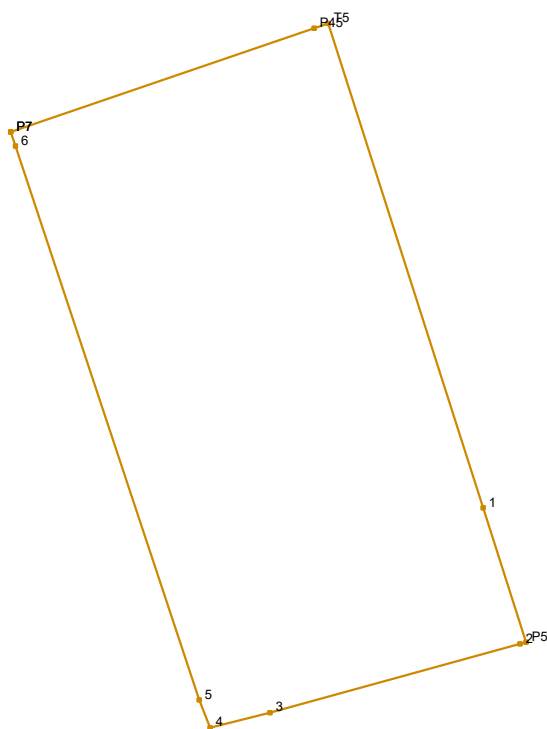

Νέα ιδιοκτησία εντός ΟΤ							
id1:1444		id2:01		Σημεία:10		Εμβαδό:573.05 m <sup>2</sup>	
Σημείο	X	Y	μήκος	Σημείο	X	Y	μήκος
P7	499761.783	3929080.134	16.67	3	499775.258	3929049.967	3.20
P45	499777.557	3929085.536	0.78	4	499772.158	3929049.185	1.55
T5	499778.294	3929085.789	26.44	5	499771.589	3929050.627	30.32
1	499786.337	3929060.606	7.32	6	499762.039	3929079.403	0.77
P5	499788.564	3929053.633	0.32	P7	499761.783	3929080.134	
2	499788.259	3929053.549	13.49				

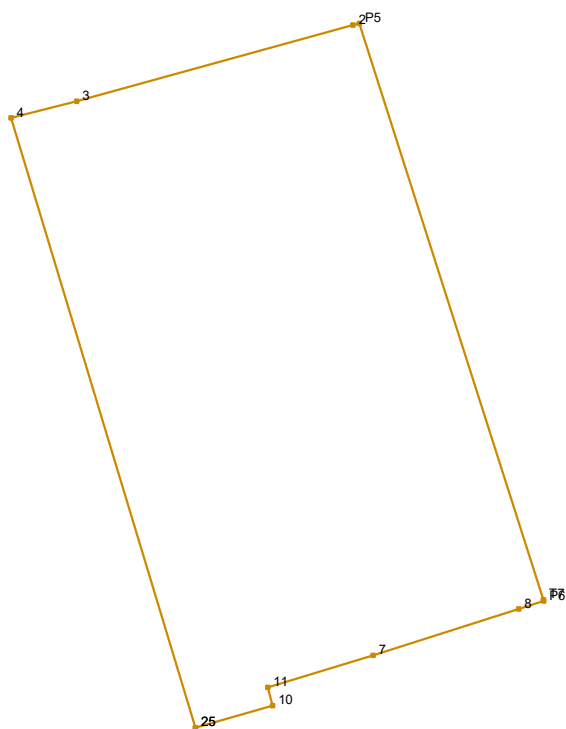

Νέα ιδιοκτησία εντός ΟΤ							
id1:1444		id2:02		Σημεία:11		Εμβαδό:500.00 m <sup>2</sup>	
Σημείο	X	Y	μήκος	Σημείο	X	Y	μήκος
25	499780.853	3929020.460	30.01	P6	499797.248	3929026.424	1.22
4	499772.158	3929049.185	3.20	8	499796.080	3929026.059	7.20
3	499775.258	3929049.967	13.49	7	499789.221	3929023.869	5.18
2	499788.259	3929053.549	0.32	11	499784.259	3929022.366	0.89
P5	499788.564	3929053.633	28.50	10	499784.480	3929021.507	3.77
T7	499797.235	3929026.482	0.06	25	499780.853	3929020.460	

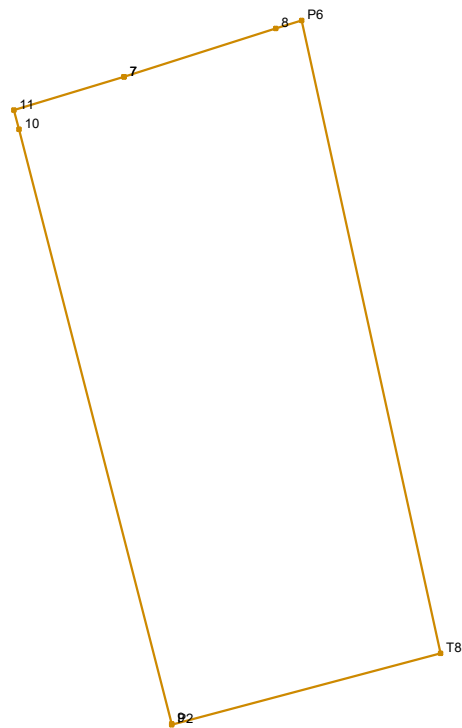

Νέα ιδιοκτησία εντός ΟΤ							
id1:1444		id2:03		Σημεία:8		Εμβαδό:378.25 m <sup>2</sup>	
Σημείο	X	Y	μήκος	Σημείο	X	Y	μήκος
7	499789.221	3929023.869	7.20	9	499791.378	3928994.640	27.74
8	499796.080	3929026.059	1.22	10	499784.480	3929021.507	0.89
P6	499797.248	3929026.424	29.28	11	499784.259	3929022.366	5.18
T8	499803.530	3928997.826	12.56	7	499789.221	3929023.869	
P2	499791.388	3928994.602	0.04				



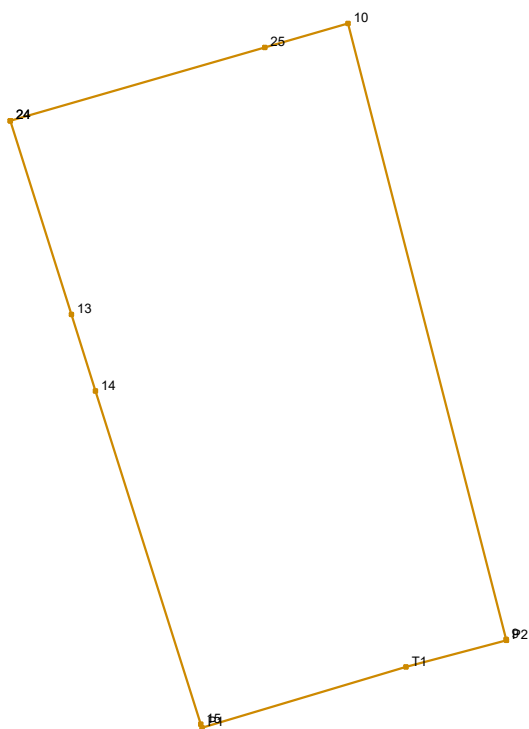

Νέα ιδιοκτησία εντός ΟΤ							
id1:1444		id2:04		Σημεία:10		Εμβαδό:403.76 m <sup>2</sup>	
Σημείο	X	Y	μήκος	Σημείο	X	Y	μήκος
24	499769.753	3929017.255	11.55	P1	499778.115	3928990.791	0.16
25	499780.853	3929020.460	3.77	15	499778.065	3928990.944	15.24
10	499784.480	3929021.507	27.74	14	499773.474	3929005.475	3.49
9	499791.378	3928994.640	0.04	13	499772.422	3929008.806	8.86
P2	499791.388	3928994.602	4.54	24	499769.753	3929017.255	
T1	499787.003	3928993.437	9.27				

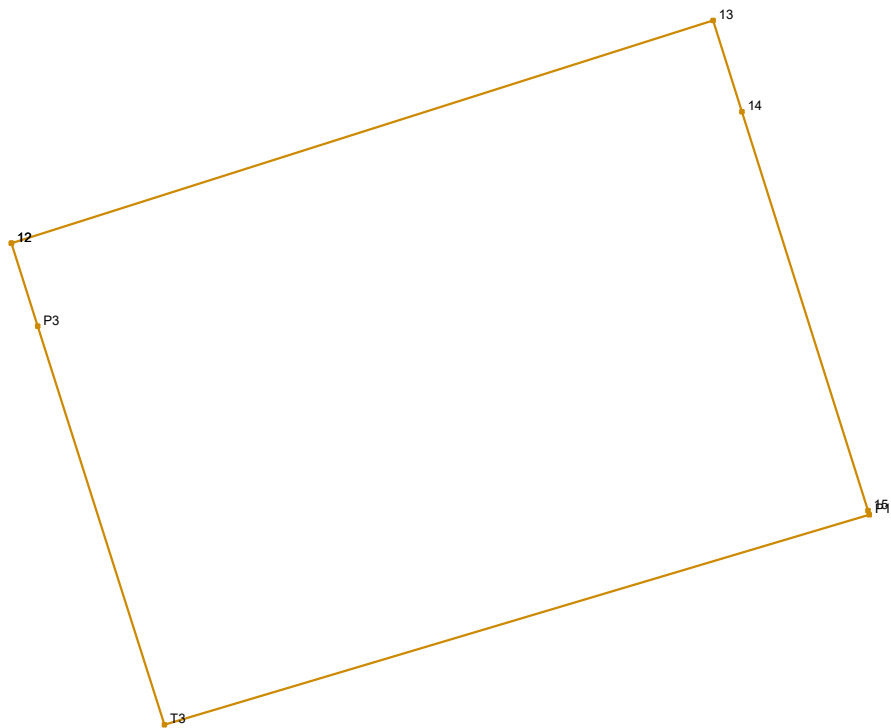

Νέα ιδιοκτησία εντός ΟΤ							
id1:1444		id2:05		Σημεία:7		Εμβαδό:500.00 m <sup>2</sup>	
Σημείο	X	Y	μήκος	Σημείο	X	Y	μήκος
12	499746.852	3929000.677	26.83	P1	499778.115	3928990.791	26.80
13	499772.422	3929008.806	3.49	T3	499752.427	3928983.141	15.23
14	499773.474	3929005.475	15.24	P3	499747.812	3928997.657	3.17
15	499778.065	3928990.944	0.16	12	499746.852	3929000.677	

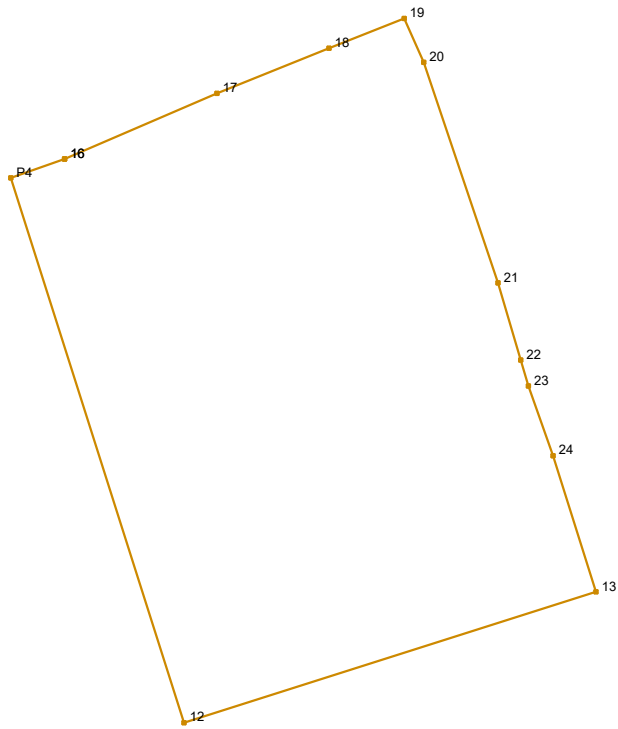

Νέα ιδιοκτησία εντός ΟΤ							
id1:1444		id2:06		Σημεία:12		Εμβαδό:976.24 m <sup>2</sup>	
Σημείο	X	Y	μήκος	Σημείο	X	Y	μήκος
16	499739.451	3929035.668	10.29	23	499768.234	3929021.577	4.58
17	499748.897	3929039.744	7.50	24	499769.753	3929017.255	8.86
18	499755.856	3929042.546	5.02	13	499772.422	3929008.806	26.83
19	499760.527	3929044.396	2.99	12	499746.852	3929000.677	35.49
20	499761.727	3929041.660	14.44	P4	499736.099	3929034.499	3.55
21	499766.339	3929027.980	5.00	16	499739.451	3929035.668	
22	499767.759	3929023.182	1.67				

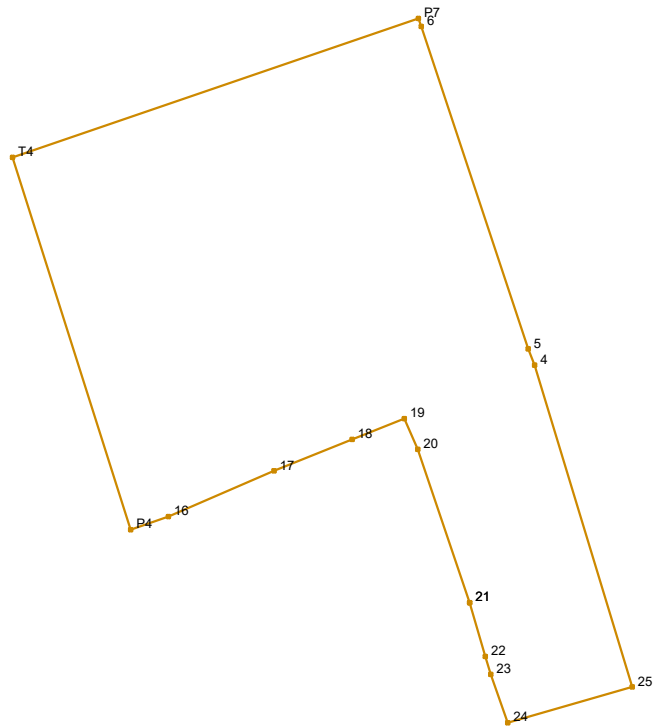

Νέα ιδιοκτησία εντός ΟΤ							
id1:1444		id2:07		Σημεία:16		Εμβαδό:1651.07 m <sup>2</sup>	
Σημείο	X	Y	μήκος	Σημείο	X	Y	μήκος
21	499766.339	3929027.980		6	499762.039	3929079.403	
			14.44				30.32
20	499761.727	3929041.660		5	499771.589	3929050.627	
			2.99				1.55
19	499760.527	3929044.396		4	499772.158	3929049.185	
			5.02				30.01
18	499755.856	3929042.546		25	499780.853	3929020.460	
			7.50				11.55
17	499748.897	3929039.744		24	499769.753	3929017.255	
			10.29				4.58
16	499739.451	3929035.668		23	499768.234	3929021.577	
			3.55				1.67
P4	499736.099	3929034.499		22	499767.759	3929023.182	
			34.86				5.00
T4	499725.538	3929067.721		21	499766.339	3929027.980	
			38.31				
P7	499761.783	3929080.134					
			0.77				

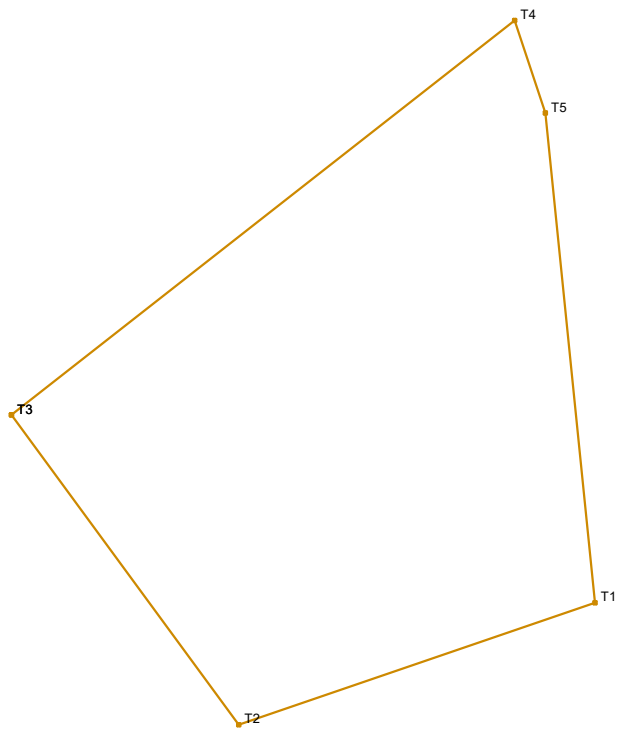

Νέα ιδιοκτησία εντός ΟΤ							
id1:1445		id2:01		Σημεία:5		Εμβαδό:4624.57 m <sup>2</sup>	
Σημείο	X	Y	μήκος	Σημείο	X	Y	μήκος
T3	499717.788	3929129.840	89.39	T1	499799.360	3929103.573	52.64
T4	499788.124	3929185.004		13.65	T2	499749.560	
T5	499792.399	3929172.043	68.82	T3	499717.788	3929129.840	

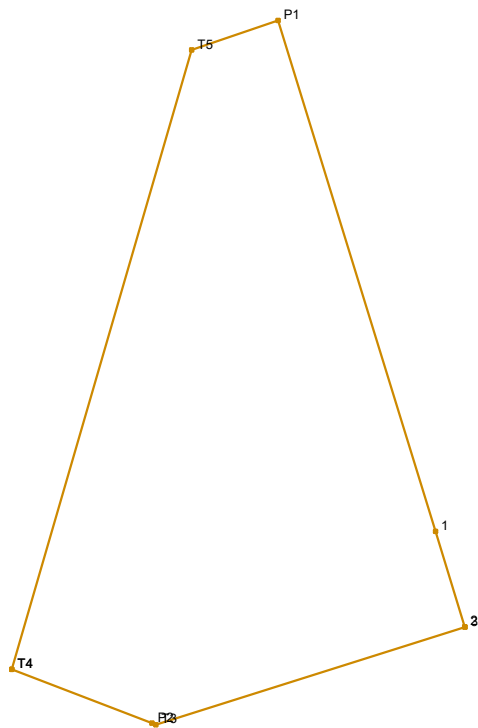

Νέα ιδιοκτησία εντός ΟΤ							
id1:1447		id2:01		Σημεία:8		Εμβαδό:787.67 m <sup>2</sup>	
Σημείο	X	Y	μήκος	Σημείο	X	Y	μήκος
T4	499658.394	3929007.937		3	499688.276	3929010.738	
			42.54				21.37
T5	499670.251	3929048.786		T3	499667.899	3929004.293	
			6.03				0.28
P1	499675.959	3929050.741		P2	499667.638	3929004.393	
			35.26				9.90
1	499686.335	3929017.040		T4	499658.394	3929007.937	
			6.57				
2	499688.269	3929010.759					
			0.02				

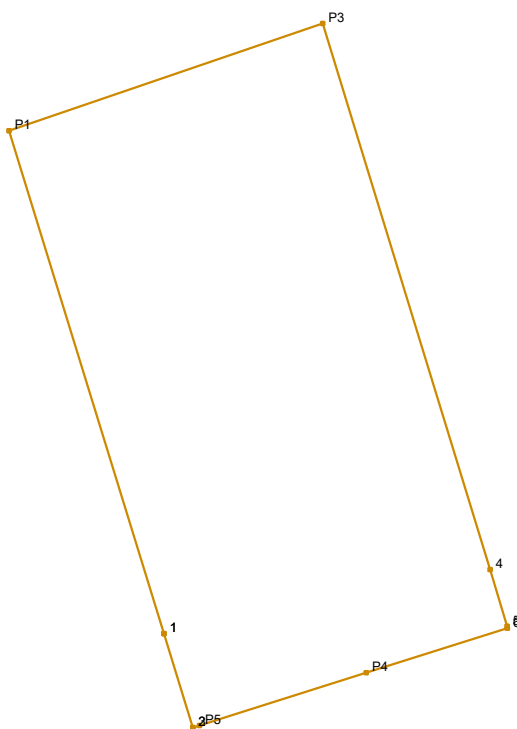

Νέα ιδιοκτησία εντός ΟΤ							
id1:1447		id2:02		Σημεία:10		Εμβαδό:934.26 m <sup>2</sup>	
Σημείο	X	Y	μήκος	Σημείο	X	Y	μήκος
1	499686.335	3929017.040	35.26	P4	499699.908	3929014.417	11.72
P1	499675.959	3929050.741		P5	499688.729	3929010.881	0.48
P3	499696.986	3929057.942	22.23	3	499688.276	3929010.738	0.02
4	499708.196	3929021.339	38.28	2	499688.269	3929010.759	6.57
5	499709.331	3929017.533	3.97	1	499686.335	3929017.040	
6	499709.368	3929017.409	0.13				
			9.92				

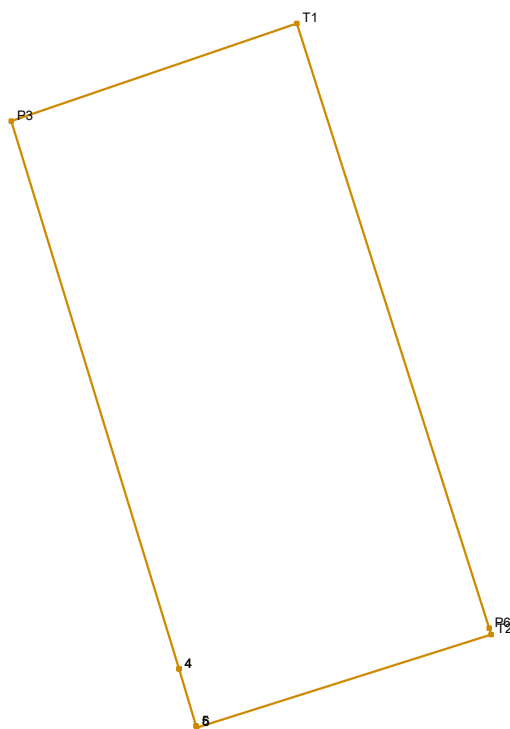

Νέα ιδιοκτησία εντός ΟΤ							
id1:1447		id2:03		Σημεία:7		Εμβαδό:869.33 m <sup>2</sup>	
Σημείο	X	Y	μήκος	Σημείο	X	Y	μήκος
4	499708.196	3929021.339	38.28	T2	499729.060	3929023.637	20.65
P3	499696.986	3929057.942	20.18	6	499709.368	3929017.409	0.13
T1	499716.075	3929064.480	42.42	5	499709.331	3929017.533	3.97
P6	499728.926	3929024.055	0.44	4	499708.196	3929021.339	



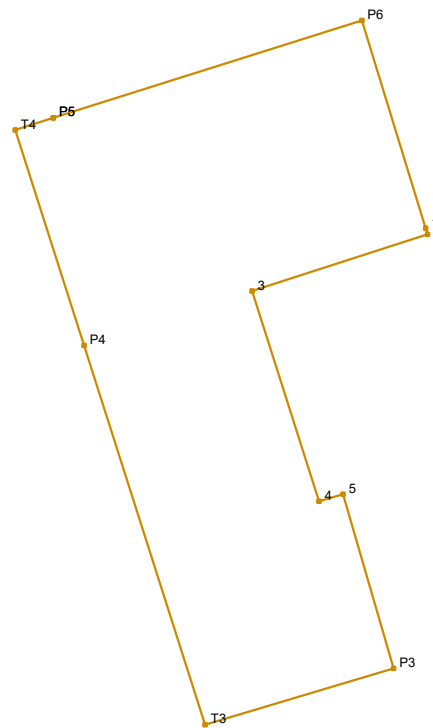

Νέα ιδιοκτησία εντός ΟΤ							
id1:1449		id2:01		Σημεία:11		Εμβαδό:589.09 m <sup>2</sup>	
Σημείο	X	Y	μήκος	Σημείο	X	Y	μήκος
P5	499667.583	3928997.900	19.86	5	499685.369	3928974.790	11.14
P6	499686.523	3929003.890	13.35	P3	499688.475	3928964.096	12.09
1	499690.429	3928991.128	0.39	T3	499676.884	3928960.644	24.45
2	499690.543	3928990.753	11.31	P4	499669.455	3928983.938	13.88
3	499679.783	3928987.283	13.56	T4	499665.239	3928997.159	2.46
4	499683.881	3928974.358	1.55	P5	499667.583	3928997.900	

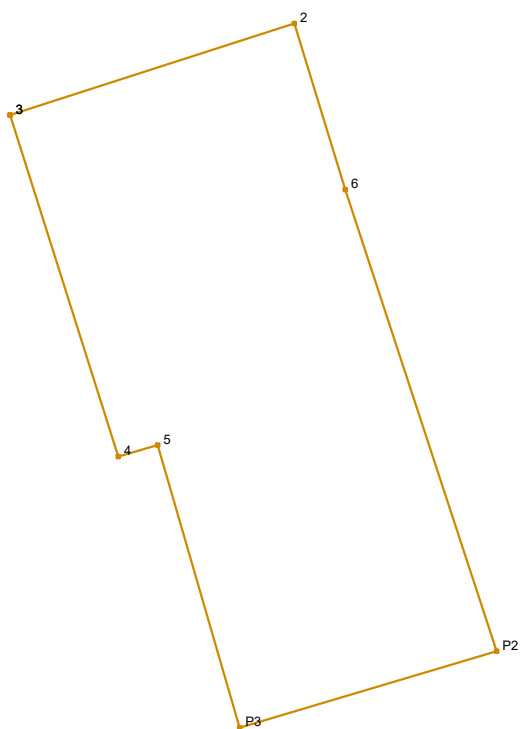

Νέα ιδιοκτησία εντός ΟΤ							
id1:1449		id2:02		Σημεία:7		Εμβαδό:265.26 m <sup>2</sup>	
Σημείο	X	Y	μήκος	Σημείο	X	Y	μήκος
3	499679.783	3928987.283	11.31	P3	499688.475	3928964.096	11.14
2	499690.543	3928990.753	6.58	5	499685.369	3928974.790	1.55
6	499692.469	3928984.460	18.38	4	499683.881	3928974.358	13.56
P2	499698.198	3928966.992	10.14	3	499679.783	3928987.283	

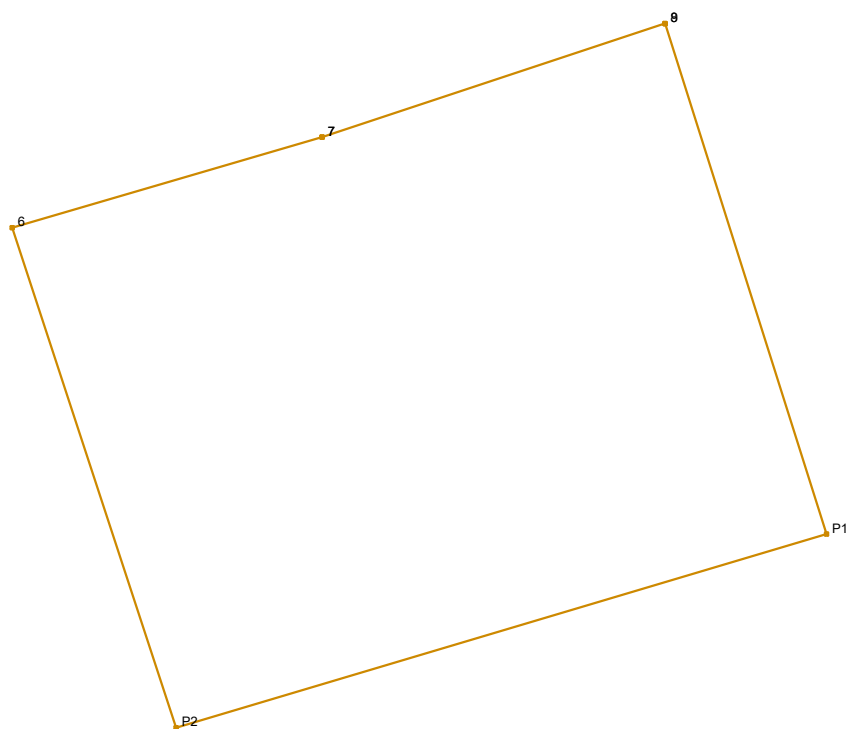

Νέα ιδιοκτησία εντός ΟΤ							
id1:1449		id2:03		Σημεία:6		Εμβαδό:438.68 m <sup>2</sup>	
Σημείο	X	Y	μήκος	Σημείο	X	Y	μήκος
7	499703.297	3928987.620	12.62	P2	499698.198	3928966.992	18.38
8	499715.273	3928991.595		0.02	6	499692.469	3928984.460
9	499715.279	3928991.574	18.69	7	499703.297	3928987.620	
P1	499720.912	3928973.756	23.70				

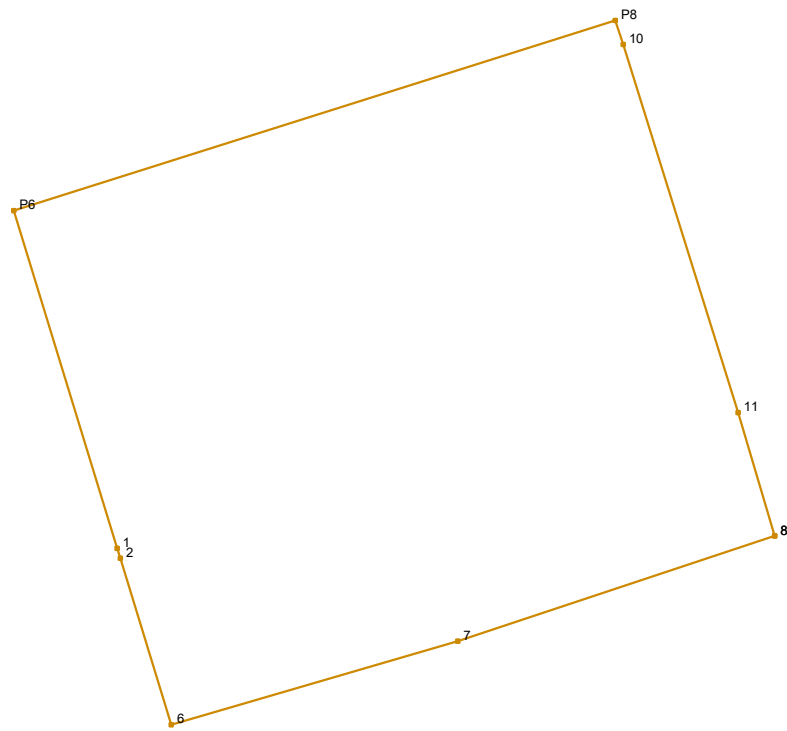

Νέα ιδιοκτησία εντός ΟΤ							
id1:1449		id2:04		Σημεία:9		Εμβαδό:489.11 m <sup>2</sup>	
Σημείο	X	Y	μήκος	Σημείο	X	Y	μήκος
8	499715.273	3928991.595	12.62	P6	499686.523	3929003.890	23.84
7	499703.297	3928987.620	11.28	P8	499709.252	3929011.079	0.96
6	499692.469	3928984.460	6.58	10	499709.556	3929010.164	14.57
2	499690.543	3928990.753	0.39	11	499713.890	3928996.254	4.86
1	499690.429	3928991.128	13.35	8	499715.273	3928991.595	

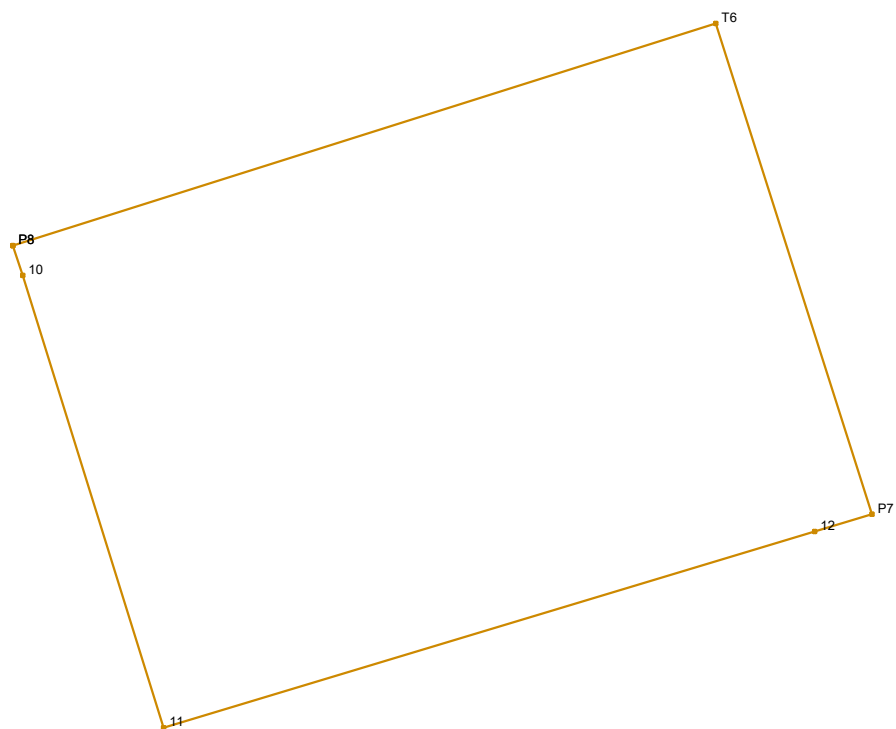

Νέα ιδιοκτησία εντός ΟΤ							
id1:1449		id2:05		Σημεία:6		Εμβαδό:356.23 m <sup>2</sup>	
Σημείο	X	Y	μήκος	Σημείο	X	Y	μήκος
P8	499709.252	3929011.079	22.68	11	499713.890	3928996.254	14.57
T6	499730.877	3929017.919		10	499709.556	3929010.164	
P7	499735.676	3929002.825	15.84	P8	499709.252	3929011.079	
			1.84				
12	499733.912	3929002.291	20.91				

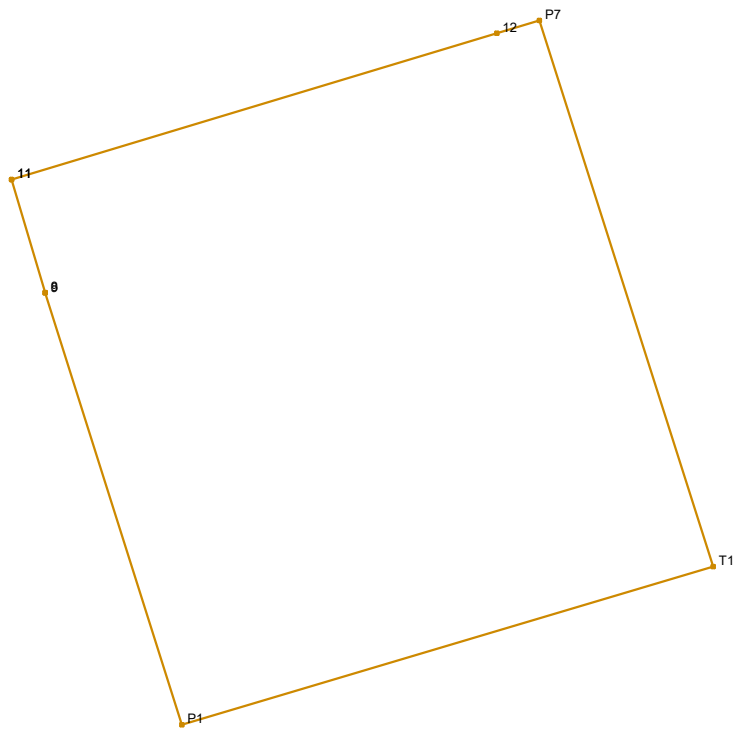

Νέα ιδιοκτησία εντός ΟΤ							
id1:1449		id2:06		Σημεία:7		Εμβαδό:539.46 m <sup>2</sup>	
Σημείο	X	Y	μήκος	Σημείο	X	Y	μήκος
11	499713.890	3928996.254	20.91	P1	499720.912	3928973.756	18.69
12	499733.912	3929002.291		1.84	9	499715.279	3928991.574
P7	499735.676	3929002.825	23.65	8	499715.273	3928991.595	4.86
T1	499742.841	3928980.286	22.88	11	499713.890	3928996.254	

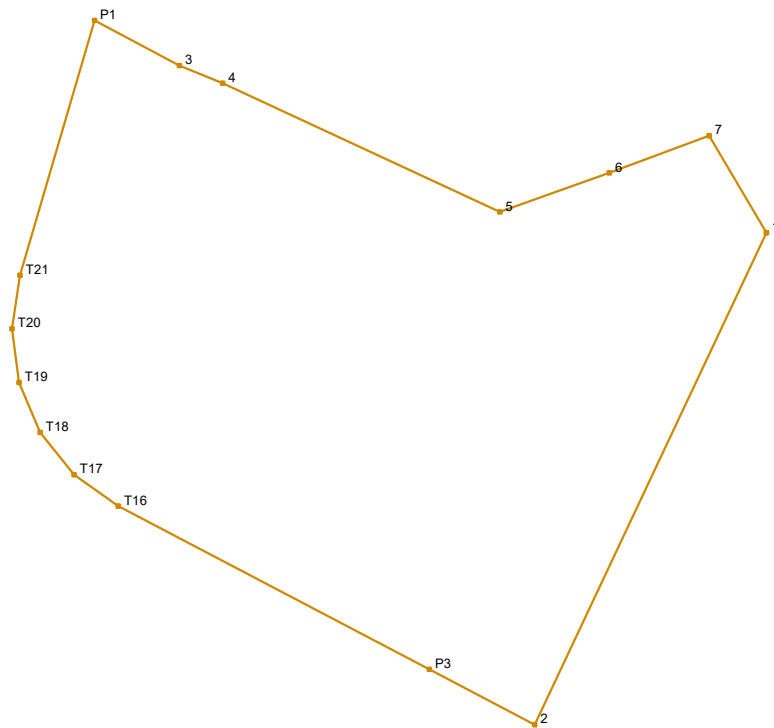

Νέα ιδιοκτησία εντός ΟΤ							
id1:1450		id2:01		Σημεία:15		Εμβαδό:501.22 m <sup>2</sup>	
Σημείο	X	Y	μήκος	Σημείο	X	Y	μήκος
1	499657.975	3928904.960	21.98	T21	499627.823	3928903.235	10.73
2	499648.611	3928885.080		P1	499630.831	3928913.535	3.88
P3	499644.354	3928887.313	4.81	3	499634.253	3928911.711	1.89
T16	499631.785	3928893.908	14.19	4	499636.003	3928910.992	12.35
T17	499630.005	3928895.180	2.19	5	499647.206	3928905.794	4.70
T18	499628.636	3928896.887	2.19	6	499651.631	3928907.367	4.31
T19	499627.781	3928898.900	2.19	7	499655.664	3928908.877	4.55
T20	499627.503	3928901.070	2.19	1	499657.975	3928904.960	
			2.19				

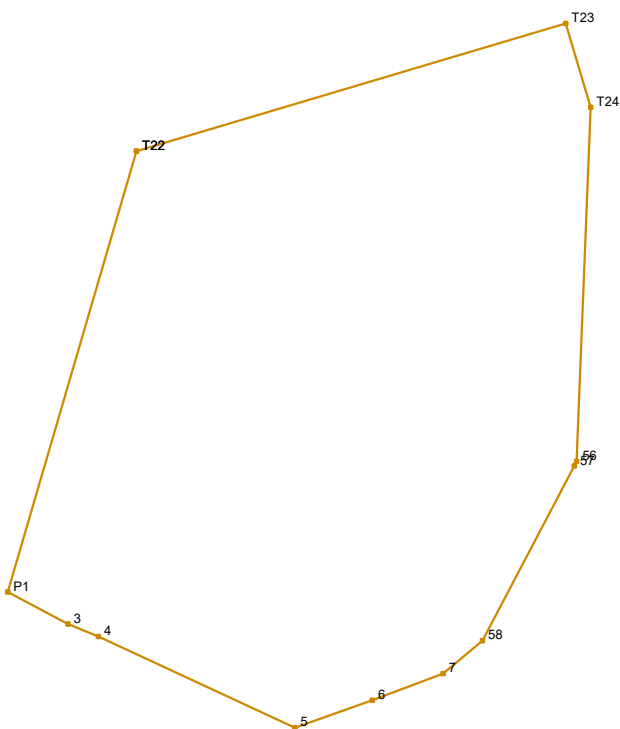

Νέα ιδιοκτησία εντός ΟΤ							
id1:1450		id2:02		Σημεία:12		Εμβαδό:938.95 m <sup>2</sup>	
Σημείο	X	Y	μήκος	Σημείο	X	Y	μήκος
T22	499638.174	3928938.682		6	499651.631	3928907.367	
			25.55				4.70
T23	499662.657	3928945.973		5	499647.206	3928905.794	
			5.00				12.35
T24	499664.084	3928941.181		4	499636.003	3928910.992	
			20.22				1.89
56	499663.279	3928920.979		3	499634.253	3928911.711	
			0.28				3.88
57	499663.150	3928920.733		P1	499630.831	3928913.535	
			11.26				26.20
58	499657.908	3928910.766		T22	499638.174	3928938.682	
			2.93				
7	499655.664	3928908.877					
			4.31				



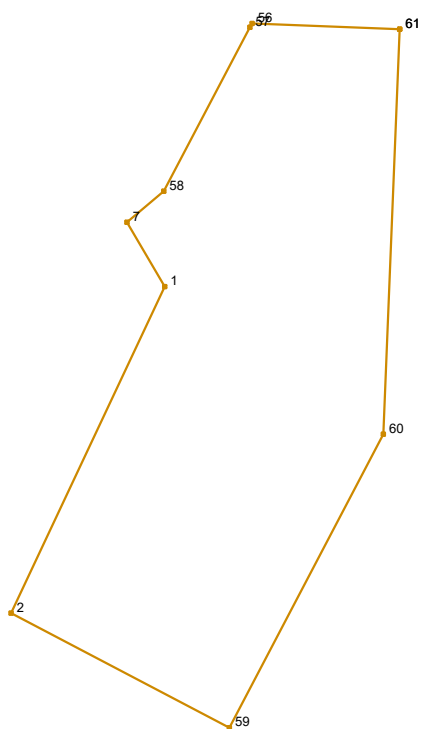

Νέα ιδιοκτησία εντός ΟΤ							
id1:1450		id2:03N		Σημεία:9		Εμβαδό:589.15 m <sup>2</sup>	
Σημείο	X	Y	μήκος	Σημείο	X	Y	μήκος
61	499672.261	3928920.616		7	499655.664	3928908.877	
			24.66				2.93
60	499671.267	3928895.973		58	499657.908	3928910.766	
			20.17				11.26
59	499661.894	3928878.110		57	499663.150	3928920.733	
			15.00				0.28
2	499648.611	3928885.080		56	499663.279	3928920.979	
			21.98				8.99
1	499657.975	3928904.960		61	499672.261	3928920.616	
			4.55				

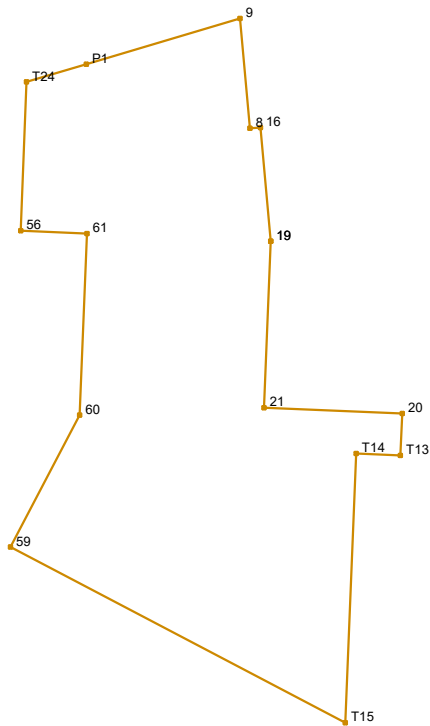

Νέα ιδιοκτησία εντός ΟΤ							
id1:1450		id2:04		Σημεία:15		Εμβαδό:2748.60 m <sup>2</sup>	
Σημείο	X	Y	μήκος	Σημείο	X	Y	μήκος
19	499697.178	3928919.582	22.61	61	499672.261	3928920.616	8.99
21	499696.266	3928896.987		18.76	56	499663.279	3928920.979
20	499715.015	3928896.231	5.69	T24	499664.084	3928941.181	8.44
T13	499714.786	3928890.543	6.00	P1	499672.169	3928943.589	21.77
T14	499708.790	3928890.785	36.54	9	499693.035	3928949.803	14.96
T15	499707.317	3928854.276	51.30	8	499694.378	3928934.899	1.41
59	499661.894	3928878.110	20.17	16	499695.789	3928934.996	15.48
60	499671.267	3928895.973	24.66	19	499697.178	3928919.582	

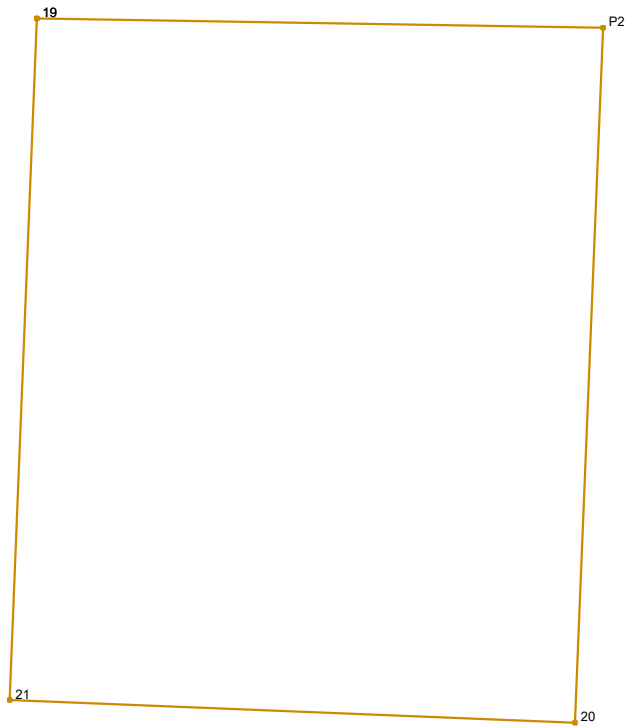

Νέα ιδιοκτησία εντός ΟΤ							
id1:1450		id2:05N		Σημεία:4		Εμβαδό:428.52 m <sup>2</sup>	
Σημείο	X	Y	μήκος	Σημείο	X	Y	μήκος
19	499697.178	3928919.582	18.77	21	499696.266	3928896.987	22.61
P2	499715.945	3928919.273		19	499697.178	3928919.582	
20	499715.015	3928896.231	23.06				
			18.76				

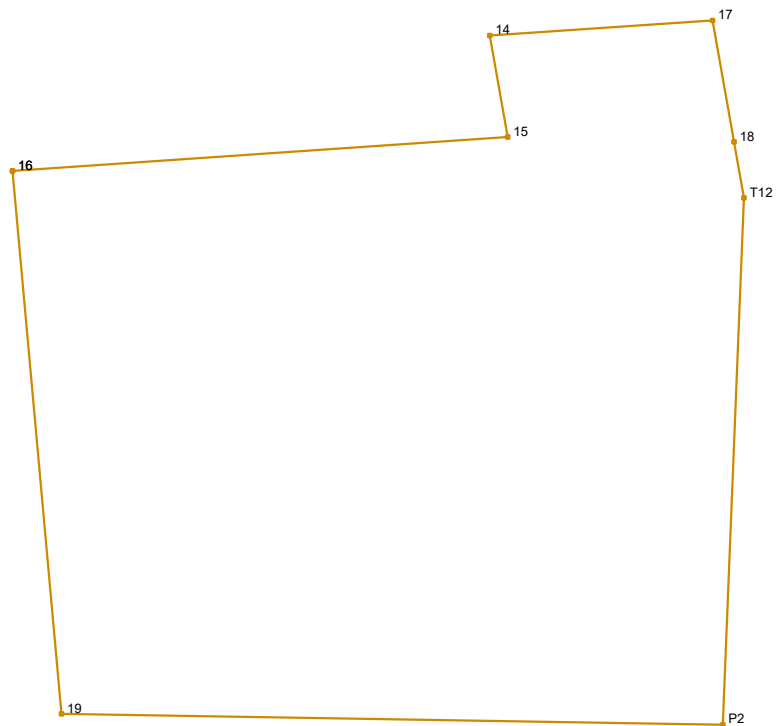

Νέα ιδιοκτησία εντός ΟΤ							
id1:1450		id2:06		Σημεία:8		Εμβαδό:340.59 m <sup>2</sup>	
Σημείο	X	Y	μήκος	Σημείο	X	Y	μήκος
16	499695.789	3928934.996	14.09	T12	499716.549	3928934.231	14.97
15	499709.844	3928935.958		2.92	P2	499715.945	3928919.273
14	499709.334	3928938.834	6.34		19	499697.178	3928919.582
17	499715.655	3928939.267		3.50	16	499695.789	3928934.996
18	499716.267	3928935.823	1.62				

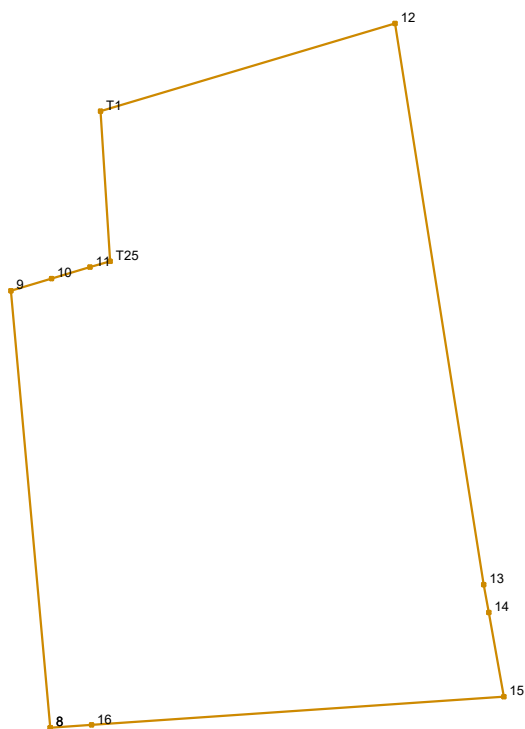

Νέα ιδιοκτησία εντός ΟΤ							
id1:1450		id2:07		Σημεία:11		Εμβαδό:300.00 m <sup>2</sup>	
Σημείο	X	Y	μήκος	Σημείο	X	Y	μήκος
8	499694.378	3928934.899	14.96	12	499706.139	3928958.922	19.38
9	499693.035	3928949.803	1.44	13	499709.165	3928939.784	0.96
10	499694.418	3928950.215	1.37	14	499709.334	3928938.834	2.92
11	499695.731	3928950.606	0.71	15	499709.844	3928935.958	14.09
T25	499696.416	3928950.810	5.13	16	499695.789	3928934.996	1.41
T1	499696.090	3928955.930	10.48	8	499694.378	3928934.899	

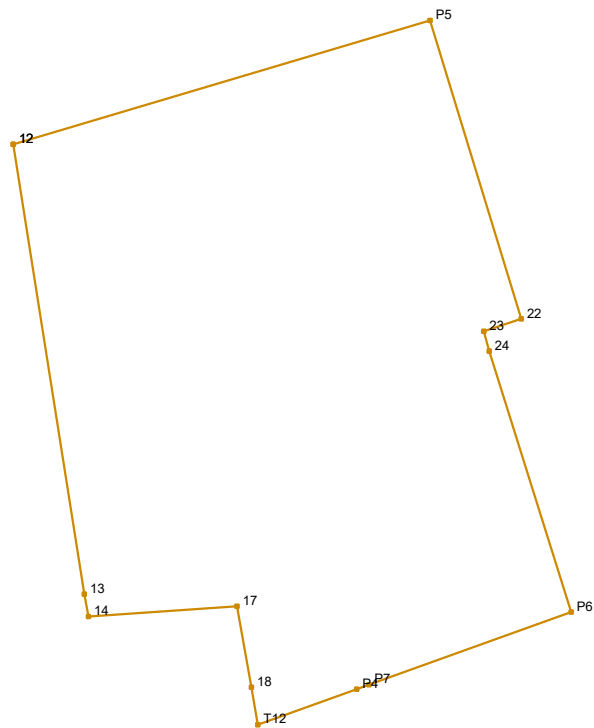

Νέα ιδιοκτησία εντός ΟΤ							
id1:1450		id2:08		Σημεία:13		Εμβαδό:477.79 m <sup>2</sup>	
Σημείο	X	Y	μήκος	Σημείο	X	Y	μήκος
12	499706.139	3928958.922	18.50	P4	499720.752	3928935.742	4.47
P5	499723.865	3928964.201		T12	499716.549	3928934.231	
22	499727.751	3928951.503	13.28	18	499716.267	3928935.823	3.50
23	499726.163	3928950.969		1.68	17	499715.655	
24	499726.388	3928950.127	0.87	14	499709.334	3928938.834	0.96
P6	499729.883	3928939.024	11.64	13	499709.165	3928939.784	
P7	499721.267	3928935.927	9.16	12	499706.139	3928958.922	
			0.55				

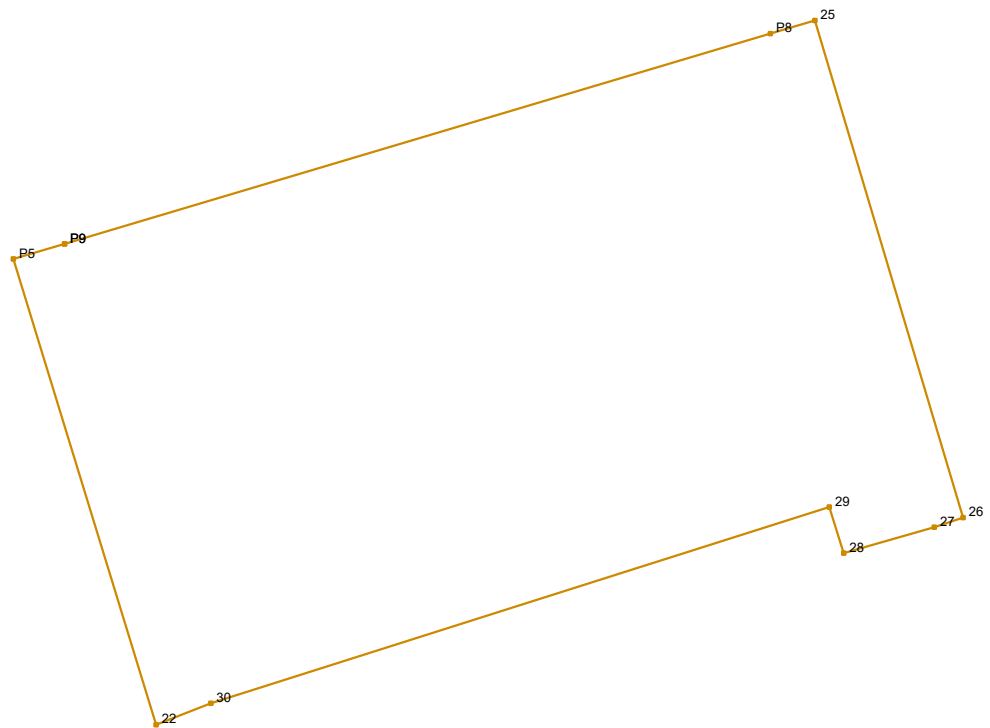

Νέα ιδιοκτησία εντός ΟΤ							
id1:1450		id2:09		Σημεία:10		Εμβαδό:300.00 m <sup>2</sup>	
Σημείο	X	Y	μήκος	Σημείο	X	Y	μήκος
P9	499725.256	3928964.615		29	499746.110	3928957.435	
			20.08				17.69
P8	499744.503	3928970.347		30	499729.250	3928952.084	
			1.27				1.61
25	499745.722	3928970.710		22	499727.751	3928951.503	
			14.15				13.28
26	499749.761	3928957.149		P5	499723.865	3928964.201	
			0.83				1.45
27	499748.978	3928956.887		P9	499725.256	3928964.615	
			2.57				
28	499746.503	3928956.178					
			1.32				

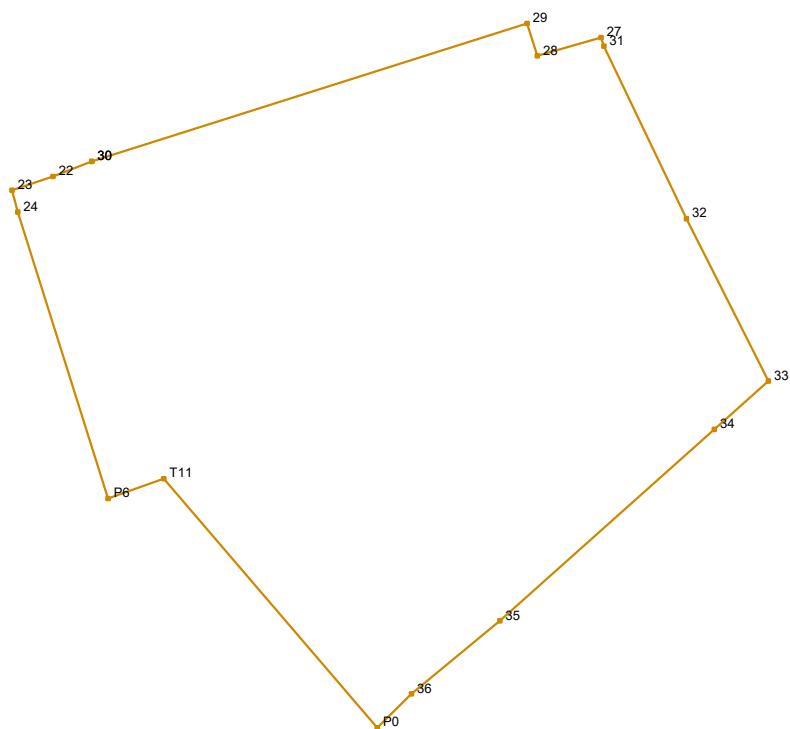

Νέα ιδιοκτησία εντός ΟΤ							
id1:1450		id2:10		Σημεία:16		Εμβαδό:469.32 m <sup>2</sup>	
Σημείο	X	Y	μήκος	Σημείο	X	Y	μήκος
30	499729.250	3928952.084	17.69	36	499741.632	3928931.471	1.87
29	499746.110	3928957.435		P0	499740.302	3928930.152	
28	499746.503	3928956.178	1.32	T11	499732.042	3928939.800	12.70
27	499748.978	3928956.887	2.57	P6	499729.883	3928939.024	2.29
31	499749.090	3928956.544	0.36	24	499726.388	3928950.127	11.64
32	499752.283	3928949.862	7.41	23	499726.163	3928950.969	0.87
33	499755.459	3928943.581	7.04	22	499727.751	3928951.503	1.68
34	499753.361	3928941.708	2.81	30	499729.250	3928952.084	1.61
35	499745.057	3928934.295	11.13				
			4.44				



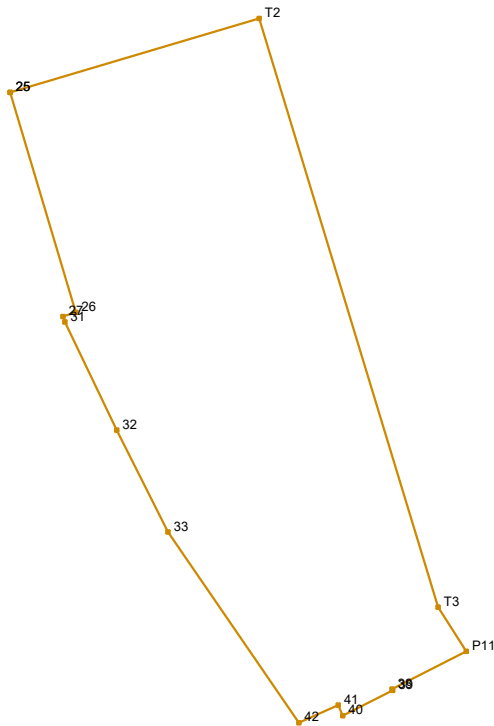

Νέα ιδιοκτησία εντός ΟΤ							
id1:1450		id2:11		Σημεία:14		Εμβαδό:625.82 m <sup>2</sup>	
Σημείο	X	Y	μήκος	Σημείο	X	Y	μήκος
25	499745.722	3928970.710	16.02	42	499763.523	3928931.814	14.26
T2	499761.078	3928975.283	37.98	33	499755.459	3928943.581	7.04
T3	499772.118	3928938.938	3.23	32	499752.283	3928949.862	7.41
P11	499773.866	3928936.222	5.14	31	499749.090	3928956.544	0.36
38	499769.284	3928933.896	0.10	27	499748.978	3928956.887	0.83
39	499769.326	3928933.804	3.45	26	499749.761	3928957.149	14.15
40	499766.238	3928932.256	0.71	25	499745.722	3928970.710	
41	499765.957	3928932.904	2.67				

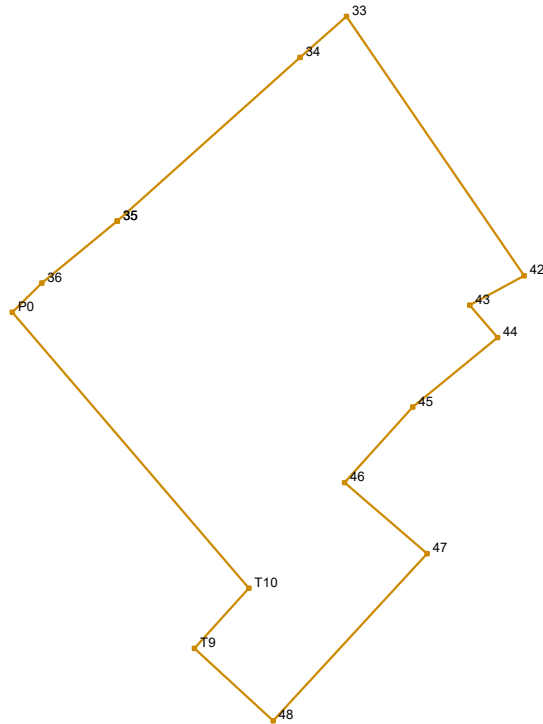

Νέα ιδιοκτησία εντός ΟΤ							
id1:1450		id2:12		Σημεία:14		Εμβαδό:349.81 m <sup>2</sup>	
Σημείο	X	Y	μήκος	Σημείο	X	Y	μήκος
35	499745.057	3928934.295	11.13	47	499759.117	3928919.203	10.31
34	499753.361	3928941.708		48	499752.130	3928911.619	
33	499755.459	3928943.581	2.81	T9	499748.566	3928914.906	3.67
42	499763.523	3928931.814	14.26	T10	499751.027	3928917.626	16.49
43	499761.051	3928930.478	2.81	P0	499740.302	3928930.152	1.87
44	499762.321	3928929.010	1.94	36	499741.632	3928931.471	4.44
45	499758.469	3928925.850	4.98	35	499745.057	3928934.295	
46	499755.367	3928922.423	4.62				
			4.94				

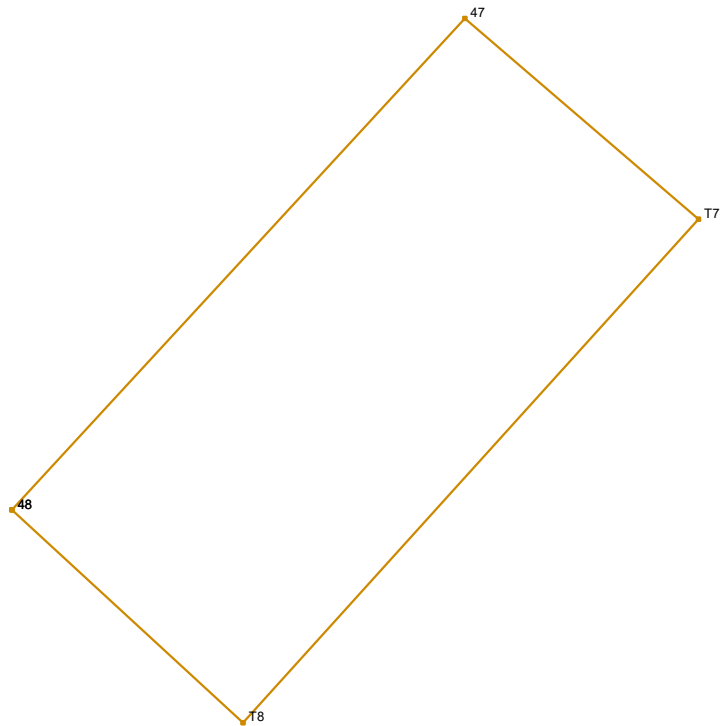

Νέα ιδιοκτησία εντός ΟΤ							
id1:1450		id2:13		Σημεία:4		Εμβαδό:49.92 m <sup>2</sup>	
Σημείο	X	Y	μήκος	Σημείο	X	Y	μήκος
48	499752.130	3928911.619	10.31	T8	499755.694	3928908.331	4.85
47	499759.117	3928919.203		4.76	48	499752.130	
T7	499762.726	3928916.103	10.48				

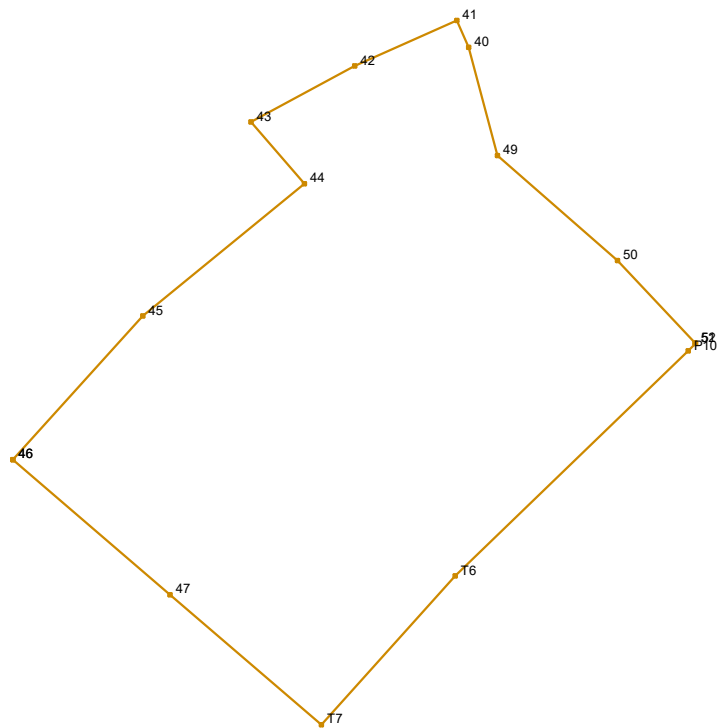

Νέα ιδιοκτησία εντός ΟΤ							
id1:1450		id2:14		Σημεία:15		Εμβαδό:131.77 m <sup>2</sup>	
Σημείο	X	Y	μήκος	Σημείο	X	Y	μήκος
46	499755.367	3928922.423		50	499769.792	3928927.173	
			4.62				2.69
45	499758.469	3928925.850		51	499771.637	3928925.214	
			4.98				0.03
44	499762.321	3928929.010		52	499771.655	3928925.195	
			1.94				0.25
43	499761.051	3928930.478		P10	499771.479	3928925.025	
			2.81				7.73
42	499763.523	3928931.814		T6	499765.917	3928919.651	
			2.67				4.77
41	499765.957	3928932.904		T7	499762.726	3928916.103	
			0.71				4.76
40	499766.238	3928932.256		47	499759.117	3928919.203	
			2.67				4.94
49	499766.929	3928929.681		46	499755.367	3928922.423	
			3.81				

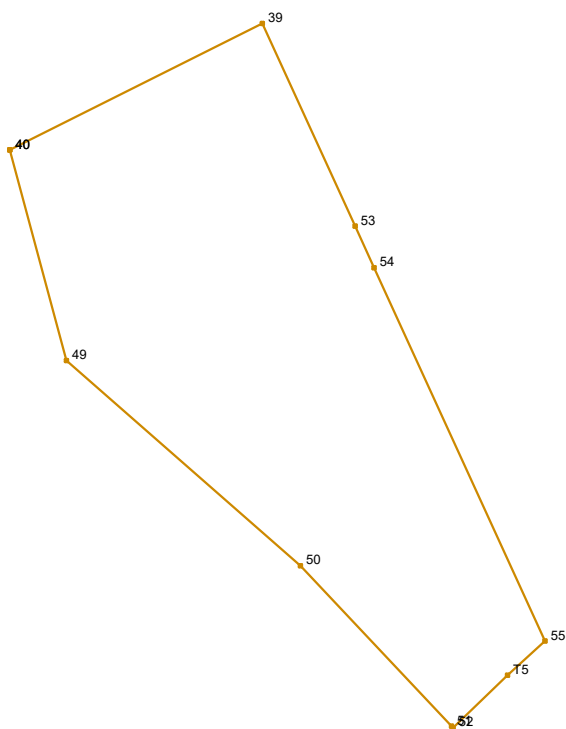

Νέα ιδιοκτησία εντός ΟΤ							
id1:1450		id2:15		Σημεία:10		Εμβαδό:25.20 m <sup>2</sup>	
Σημείο	X	Y	μήκος	Σημείο	X	Y	μήκος
40	499766.238	3928932.256		52	499771.655	3928925.195	
			3.45				0.03
39	499769.326	3928933.804		51	499771.637	3928925.214	
			2.72				2.69
53	499770.459	3928931.327		50	499769.792	3928927.173	
			0.56				3.81
54	499770.692	3928930.818		49	499766.929	3928929.681	
			5.02				2.67
55	499772.778	3928926.256		40	499766.238	3928932.256	
			0.62				
T5	499772.320	3928925.838					
			0.93				

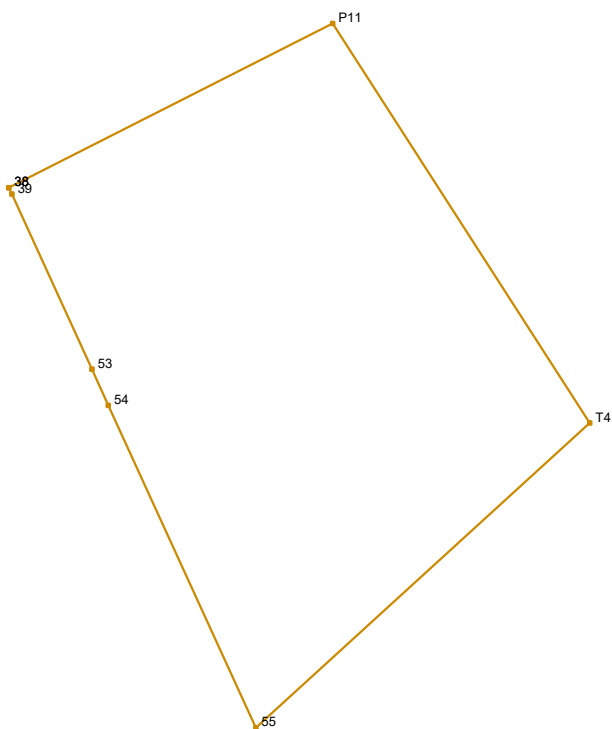

Νέα ιδιοκτησία εντός ΟΤ							
id1:1450		id2:16		Σημεία:7		Εμβαδό:42.77 m <sup>2</sup>	
Σημείο	X	Y	μήκος	Σημείο	X	Y	μήκος
38	499769.284	3928933.896	5.14	54	499770.692	3928930.818	0.56
P11	499773.866	3928936.222		6.72	53	499770.459	3928931.327
T4	499777.503	3928930.568	6.40	39	499769.326	3928933.804	0.10
55	499772.778	3928926.256	5.02	38	499769.284	3928933.896	

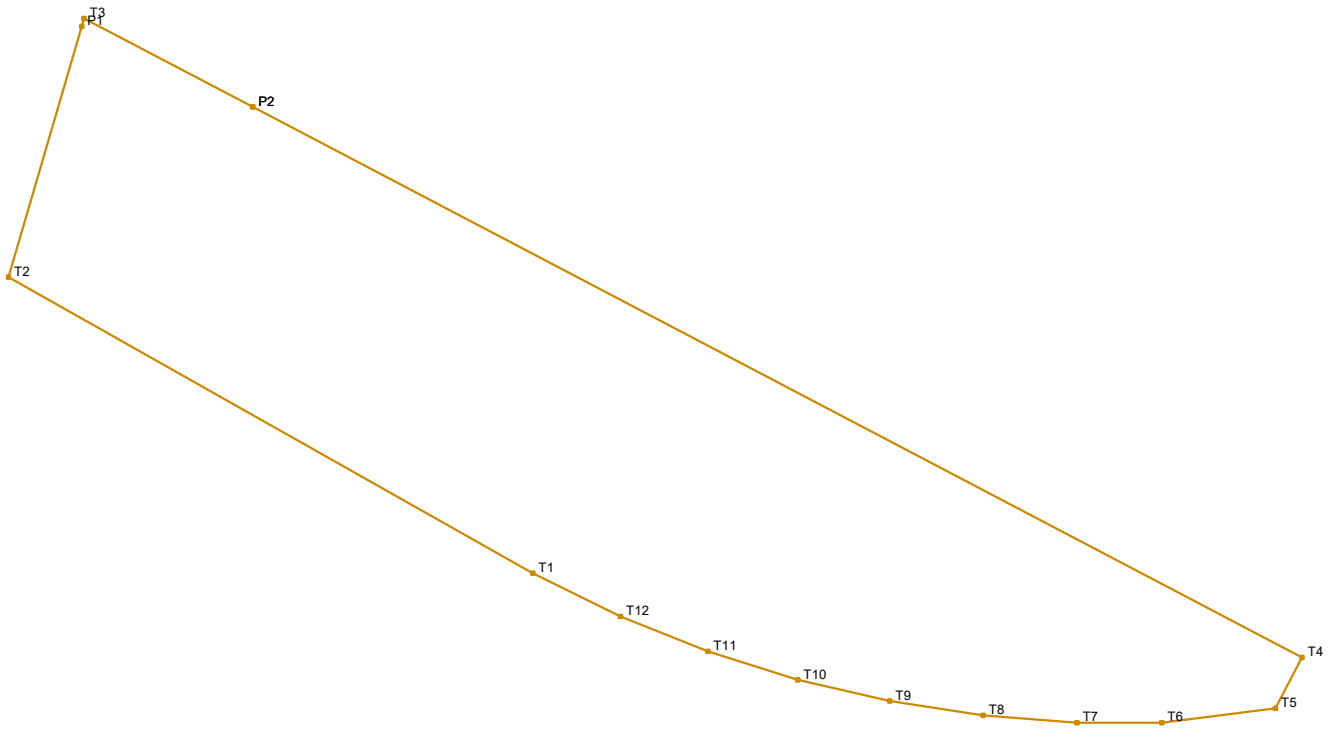

Νέα ιδιοκτησία εντός ΟΤ							
id1:1451		id2:01		Σημεία:14		Εμβαδό:1432.50 m <sup>2</sup>	
Σημείο	X	Y	μήκος	Σημείο	X	Y	μήκος
P2	499634.326	3928881.282	78.61	T11	499664.522	3928845.161	6.26
T4	499703.936	3928844.757		T12	499658.713	3928847.486	6.48
T5	499702.170	3928841.392	3.80	T1	499652.899	3928850.341	39.95
T6	499694.636	3928840.428	7.60	T2	499618.115	3928869.991	17.32
T7	499689.006	3928840.433	5.63	P1	499622.969	3928886.613	0.57
T8	499682.768	3928840.913	6.26	T3	499623.128	3928887.158	12.65
T9	499676.584	3928841.866	6.26	P2	499634.326	3928881.282	
T10	499670.490	3928843.284	6.26				

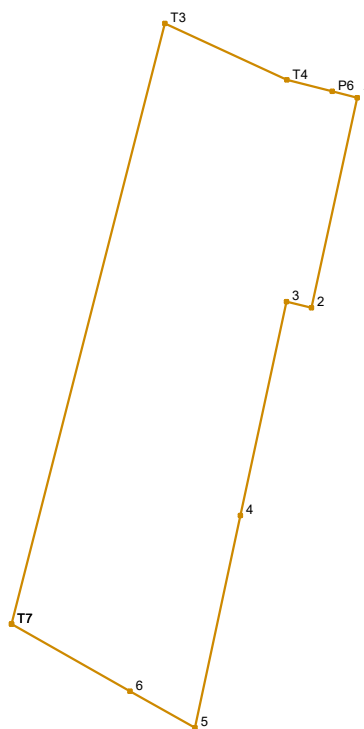

Νέα ιδιοκτησία εντός ΟΤ							
id1:1452		id2:01		Σημεία:10		Εμβαδό:1025.17 m <sup>2</sup>	
Σημείο	X	Y	μήκος	Σημείο	X	Y	μήκος
T7	499561.807	3928901.800	55.99	3	499586.632	3928930.922	19.74
T3	499575.658	3928956.044		12.13	4	499582.482	3928911.621
T4	499586.666	3928950.954	4.24	5	499578.359	3928892.449	6.72
P6	499590.772	3928949.906	2.32	6	499572.507	3928895.755	12.29
1	499593.018	3928949.332	19.41	T7	499561.807	3928901.800	
2	499588.883	3928930.372	2.32				



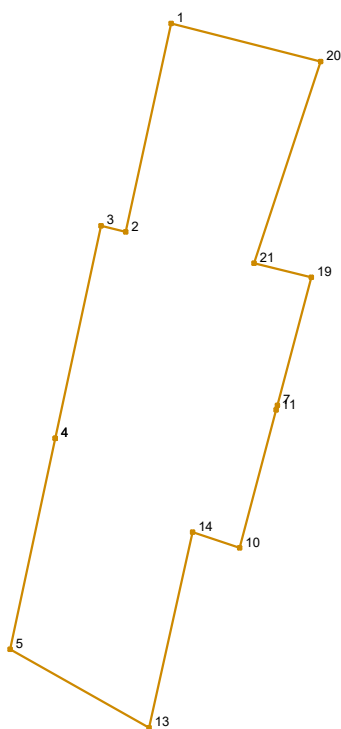

Νέα ιδιοκτησία εντός ΟΤ							
id1:1452		id2:02		Σημεία:13		Εμβαδό:957.04 m <sup>2</sup>	
Σημείο	X	Y	μήκος	Σημείο	X	Y	μήκος
4	499582.482	3928911.621	19.74	7	499602.672	3928914.622	0.45
3	499586.632	3928930.922	2.32	11	499602.558	3928914.191	12.97
2	499588.883	3928930.372	19.41	10	499599.243	3928901.656	4.52
1	499593.018	3928949.332	14.01	14	499594.958	3928903.094	18.22
20	499606.592	3928945.865	19.32	13	499590.995	3928885.311	14.51
21	499600.541	3928927.520	5.36	5	499578.359	3928892.449	19.61
19	499605.747	3928926.246	12.02	4	499582.482	3928911.621	

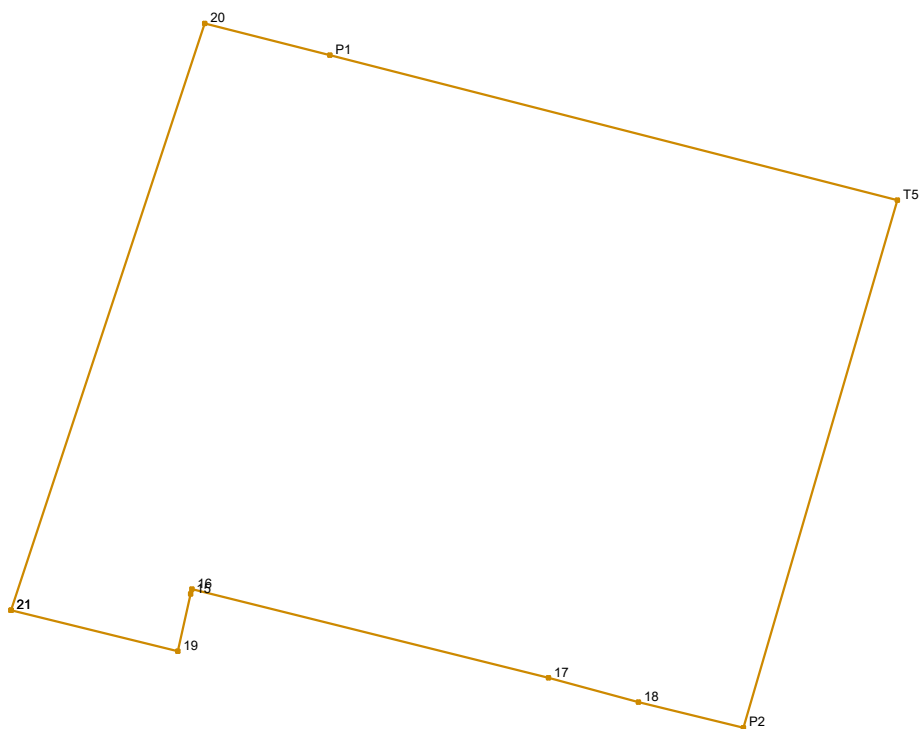

Νέα ιδιοκτησία εντός ΟΤ							
id1:1452		id2:03N		Σημεία:10		Εμβαδό:400.00 m <sup>2</sup>	
Σημείο	X	Y	μήκος	Σημείο	X	Y	μήκος
21	499600.541	3928927.520	19.32	17	499617.335	3928925.412	11.48
20	499606.592	3928945.865	4.03	16	499606.193	3928928.184	0.16
P1	499610.498	3928944.868	18.31	15	499606.153	3928928.032	1.83
T5	499628.240	3928940.337	17.17	19	499605.747	3928926.246	5.36
P2	499623.426	3928923.853	3.38	21	499600.541	3928927.520	
18	499620.140	3928924.651	2.91				

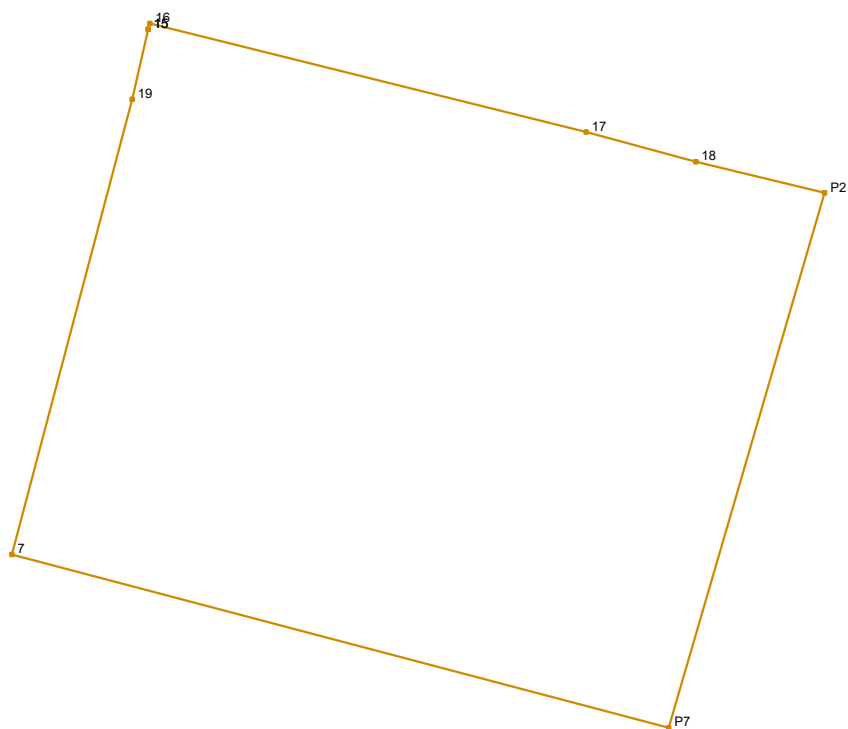

Νέα ιδιοκτησία εντός ΟΤ							
id1:1452		id2:04		Σημεία:8		Εμβαδό:247.50 m <sup>2</sup>	
Σημείο	X	Y	μήκος	Σημείο	X	Y	μήκος
15	499606.153	3928928.032	0.16	P7	499619.439	3928910.199	17.34
16	499606.193	3928928.184	11.48	7	499602.672	3928914.622	12.02
17	499617.335	3928925.412	2.91	19	499605.747	3928926.246	1.83
18	499620.140	3928924.651	3.38	15	499606.153	3928928.032	
P2	499623.426	3928923.853	14.22				

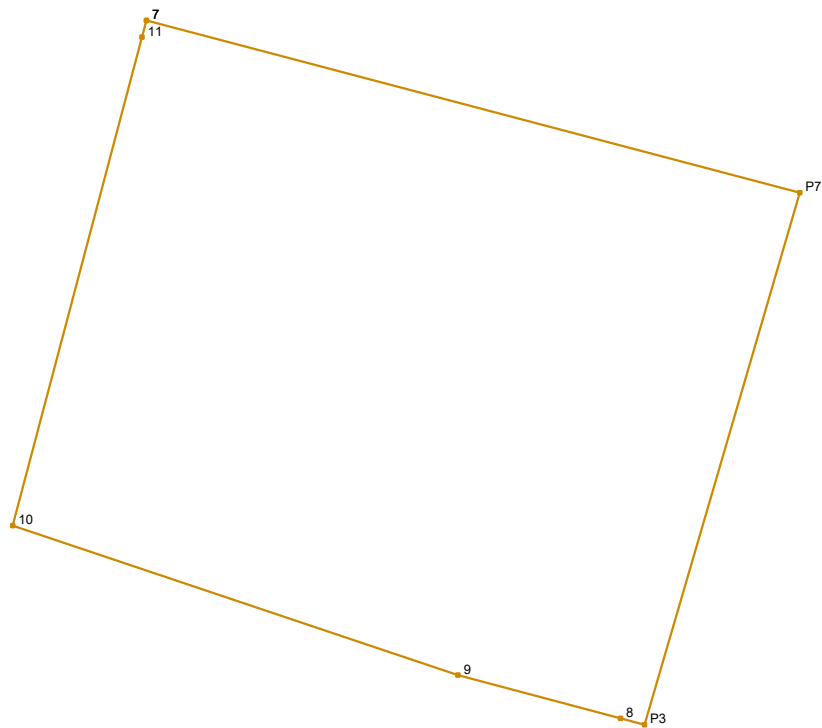

Νέα ιδιοκτησία εντός ΟΤ							
id1:1452		id2:05		Σημεία:7		Εμβαδό:239.00 m <sup>2</sup>	
Σημείο	X	Y	μήκος	Σημείο	X	Y	μήκος
7	499602.672	3928914.622	17.34	9	499610.668	3928897.822	12.05
P7	499619.439	3928910.199		14.22	10	499599.243	3928901.656
P3	499615.452	3928896.547	0.63	11	499602.558	3928914.191	0.45
8	499614.839	3928896.710	4.32	7	499602.672	3928914.622	

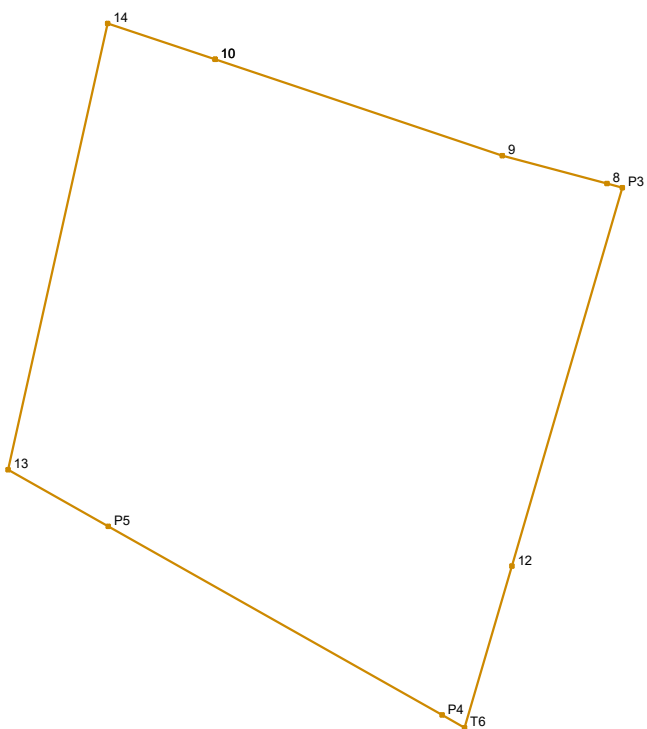

Νέα ιδιοκτησία εντός ΟΤ							
id1:1452		id2:06N		Σημεία:10		Εμβαδό:420.29 m <sup>2</sup>	
Σημείο	X	Y	μήκος	Σημείο	X	Y	μήκος
10	499599.243	3928901.656	12.05	P4	499608.269	3928875.553	15.26
9	499610.668	3928897.822	4.32	P5	499594.985	3928883.057	4.58
8	499614.839	3928896.710	0.63	13	499590.995	3928885.311	18.22
P3	499615.452	3928896.547	15.69	14	499594.958	3928903.094	4.52
12	499611.054	3928881.486	6.71	10	499599.243	3928901.656	
T6	499609.173	3928875.043	1.04				

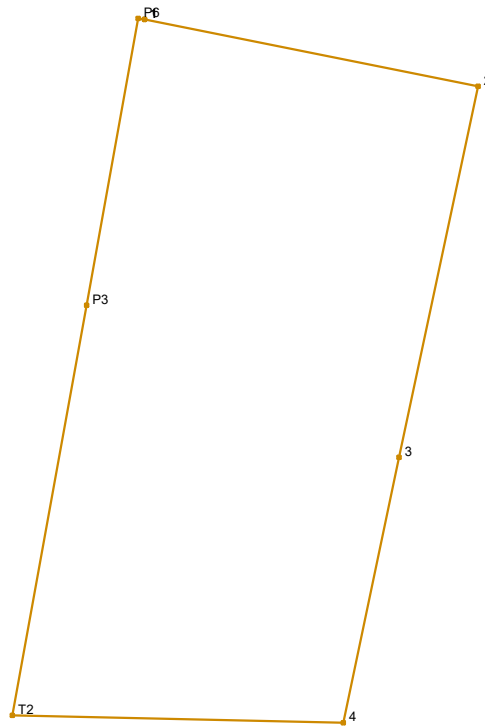

Νέα ιδιοκτησία εντός ΟΤ							
id1:1453		id2:01		Σημεία:7		Εμβαδό:504.85 m <sup>2</sup>	
Σημείο	X	Y	μήκος	Σημείο	X	Y	μήκος
1	499471.703	3928949.521	16.00	T2	499465.490	3928916.810	19.59
2	499487.392	3928946.385		P3	499468.973	3928936.091	
3	499483.669	3928928.943	17.84	P6	499471.409	3928949.580	13.71
4	499481.046	3928916.459	12.76	1	499471.703	3928949.521	0.30
			15.56				

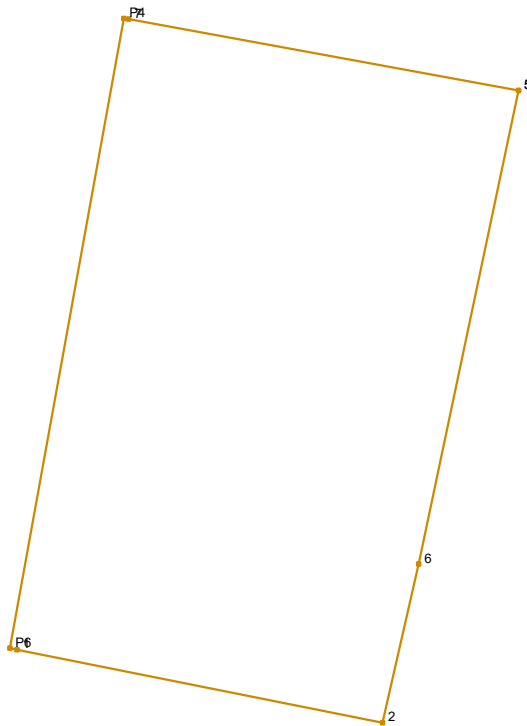

Νέα ιδιοκτησία εντός ΟΤ							
id1:1453		id2:02		Σημεία:7		Εμβαδό:464.08 m <sup>2</sup>	
Σημείο	X	Y	μήκος	Σημείο	X	Y	μήκος
5	499493.236	3928973.526	20.77	P6	499471.409	3928949.580	27.48
6	499488.950	3928953.202	6.99	P4	499476.294	3928976.620	0.20
2	499487.392	3928946.385	16.00	7	499476.495	3928976.584	17.02
1	499471.703	3928949.521	0.30	5	499493.236	3928973.526	

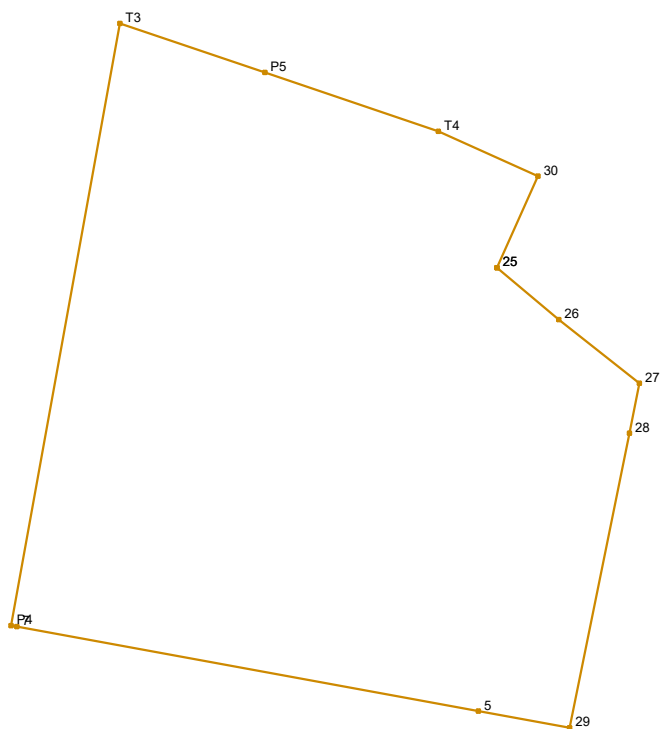

Νέα ιδιοκτησία εντός ΟΤ							
id1:1453		id2:03		Σημεία:12		Εμβαδό:400.00 m <sup>2</sup>	
Σημείο	X	Y	μήκος	Σημείο	X	Y	μήκος
25	499493.914	3928989.606		P4	499476.294	3928976.620	22.20
26	499496.157	3928987.724	2.93	T3	499480.240	3928998.469	5.55
27	499499.082	3928985.408	3.73	P5	499485.499	3928996.683	6.65
28	499498.717	3928983.603	1.84	T4	499491.794	3928994.546	3.96
29	499496.553	3928972.920	10.90	30	499495.405	3928992.922	3.64
5	499493.236	3928973.526	3.37	25	499493.914	3928989.606	
7	499476.495	3928976.584	17.02				
			0.20				



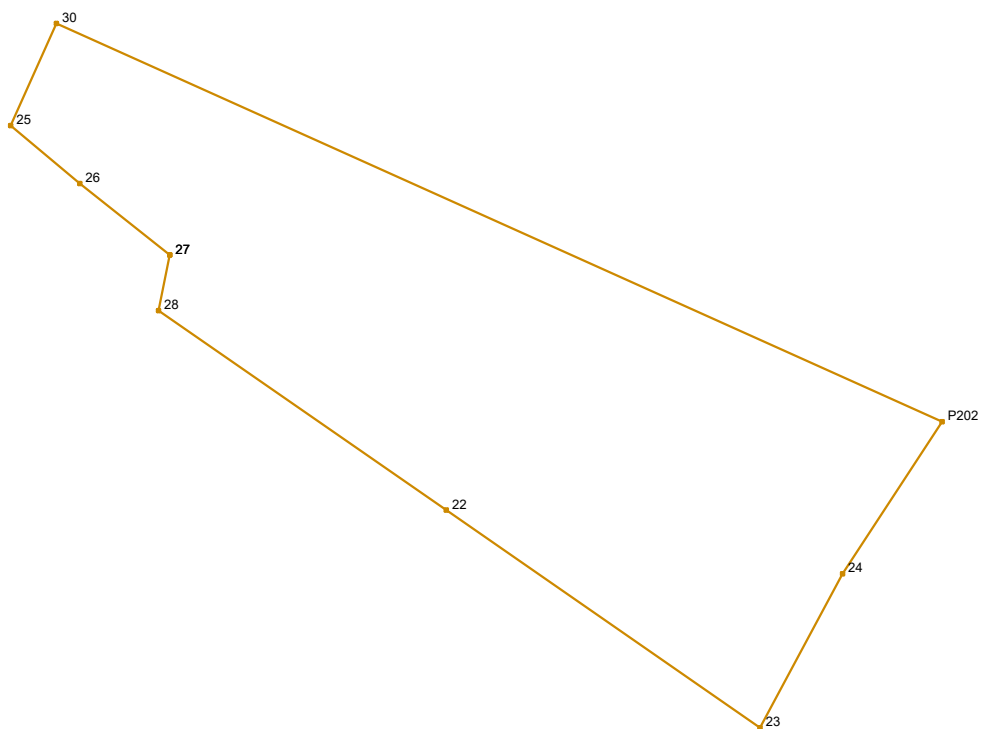

Νέα ιδιοκτησία εντός ΟΤ							
id1:1453		id2:04		Σημεία:9		Εμβαδό:255.11 m <sup>2</sup>	
Σημείο	X	Y	μήκος	Σημείο	X	Y	μήκος
27	499499.082	3928985.408	3.73	24	499520.906	3928975.061	5.67
26	499496.157	3928987.724		23	499518.226	3928970.066	
25	499493.914	3928989.606	3.64	22	499508.049	3928977.127	11.36
30	499495.405	3928992.922		28	499498.717	3928983.603	
P202	499524.137	3928980.000	5.90	27	499499.082	3928985.408	

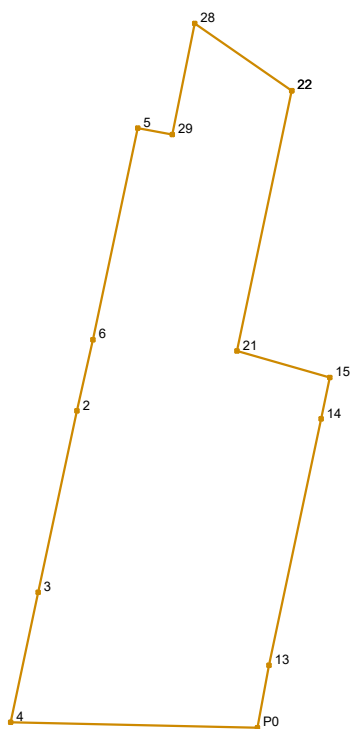

Νέα ιδιοκτησία εντός ΟΤ							
id1:1453		id2:05		Σημεία:13		Εμβαδό:1210.53 m <sup>2</sup>	
Σημείο	X	Y	μήκος	Σημείο	X	Y	μήκος
22	499508.049	3928977.127	25.55	3	499483.669	3928928.943	17.84
21	499502.777	3928952.123		9.28	2	499487.392	3928946.385
15	499511.705	3928949.585	4.06	6	499488.950	3928953.202	20.77
14	499510.865	3928945.616	24.23	5	499493.236	3928973.526	3.37
13	499505.854	3928921.915	6.09	29	499496.553	3928972.920	10.90
P0	499504.737	3928915.925	23.70	28	499498.717	3928983.603	11.36
4	499481.046	3928916.459	12.76	22	499508.049	3928977.127	

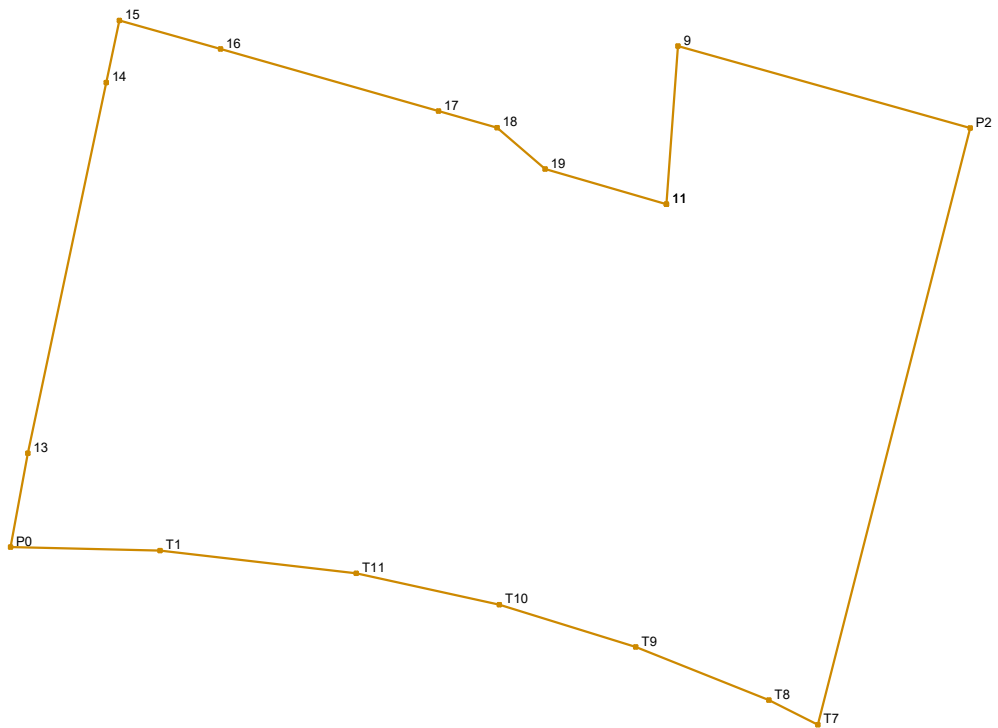

Νέα ιδιοκτησία εντός ΟΤ							
ιδ1:1453		ιδ2:06		Σημεία:17		Εμβαδό:1782.24 m <sup>2</sup>	
Σημείο	X	Y	μήκος	Σημείο	X	Y	μήκος
11	499546.648	3928937.839		P0	499504.737	3928915.925	6.09
9	499547.395	3928947.947	10.14	13	499505.854	3928921.915	24.23
P2	499566.059	3928942.704	19.39	14	499510.865	3928945.616	4.06
T7	499556.323	3928904.572	39.36	15	499511.705	3928949.585	6.71
T8	499553.199	3928906.147	3.50	16	499518.159	3928947.750	14.49
T9	499544.695	3928909.549	9.16	17	499532.100	3928943.787	3.89
T10	499535.966	3928912.235	9.13	18	499535.838	3928942.724	4.06
T11	499526.835	3928914.243	9.35	19	499538.910	3928940.077	8.06
T1	499514.285	3928915.710	12.64	11	499546.648	3928937.839	
			9.55				

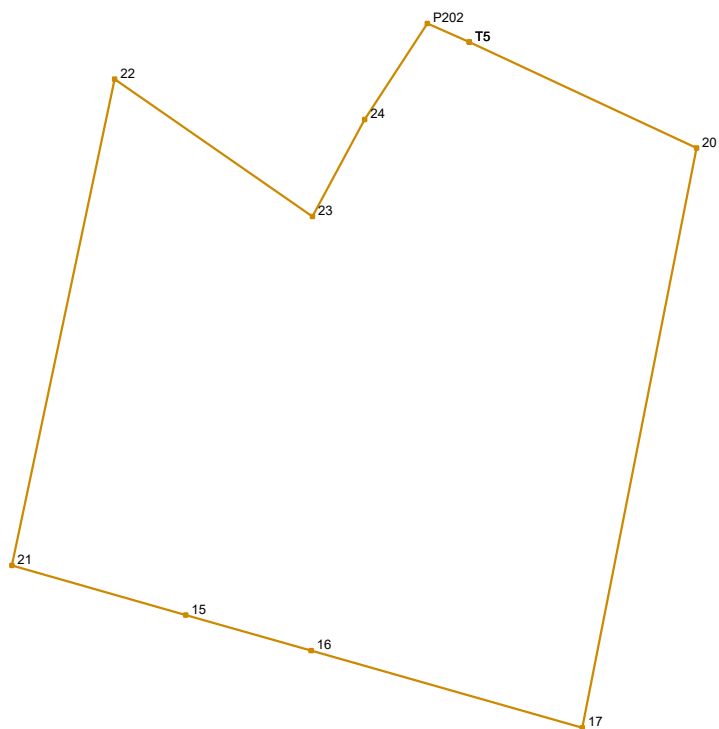

Νέα ιδιοκτησία εντός ΟΤ							
id1:1453		id2:07N		Σημεία:10		Εμβαδό:846.53 m <sup>2</sup>	
Σημείο	X	Y	μήκος	Σημείο	X	Y	μήκος
T5	499526.282	3928979.036		22	499508.049	3928977.127	12.90
20	499537.973	3928973.587	12.90	23	499518.226	3928970.066	12.39
17	499532.100	3928943.787	30.37	24	499520.906	3928975.061	5.67
16	499518.159	3928947.750	14.49	P202	499524.137	3928980.000	5.90
15	499511.705	3928949.585	6.71	T5	499526.282	3928979.036	2.35
21	499502.777	3928952.123	9.28				
			25.55				

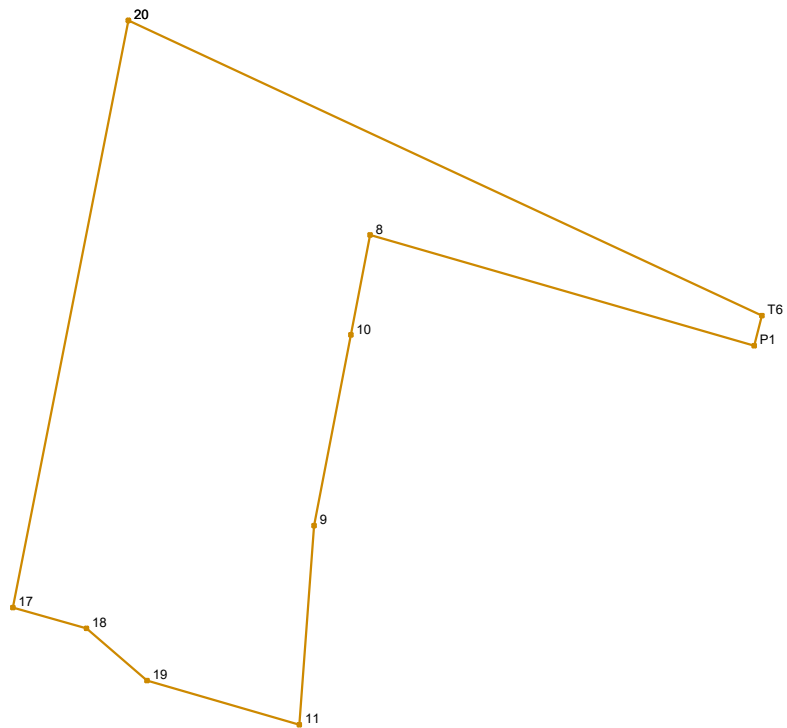

Νέα ιδιοκτησία εντός ΟΤ							
id1:1453		id2:08N		Σημεία:10		Εμβαδό:500.00 m <sup>2</sup>	
Σημείο	X	Y	μήκος	Σημείο	X	Y	μήκος
20	499537.973	3928973.587	35.47	11	499546.648	3928937.839	8.06
T6	499570.119	3928958.604		19	499538.910	3928940.077	4.06
P1	499569.727	3928957.066	1.59	18	499535.838	3928942.724	3.89
8	499550.231	3928962.697	20.29	17	499532.100	3928943.787	30.37
10	499549.255	3928957.620	5.17	20	499537.973	3928973.587	
9	499547.395	3928947.947	9.85				
			10.14				

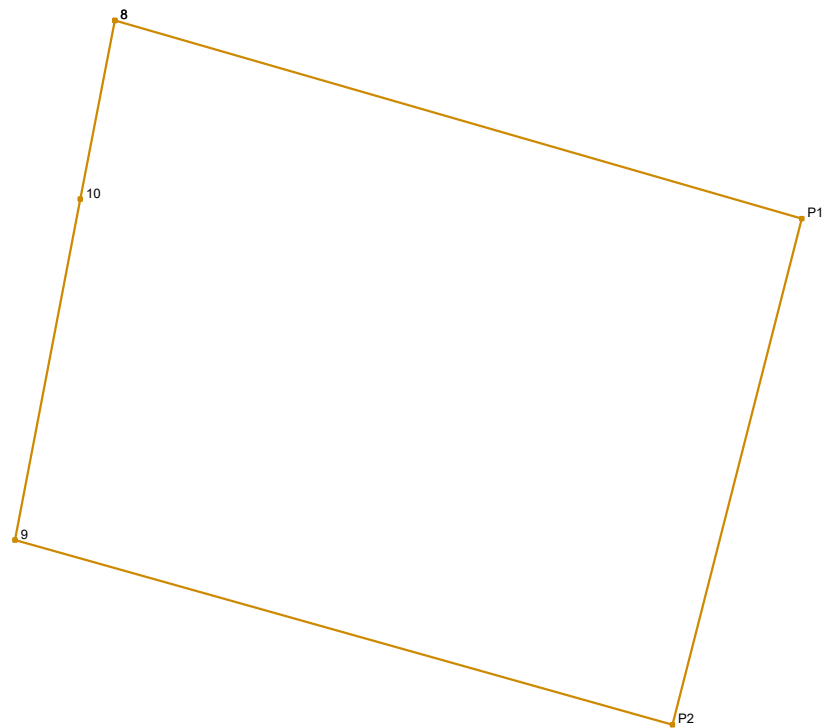

Νέα ιδιοκτησία εντός ΟΤ							
id1:1453		id2:09		Σημεία:5		Εμβαδό:295.41 m <sup>2</sup>	
Σημείο	X	Y	μήκος	Σημείο	X	Y	μήκος
8	499550.231	3928962.697	20.29	9	499547.395	3928947.947	9.85
P1	499569.727	3928957.066		14.82	10	499549.255	3928957.620
P2	499566.059	3928942.704	19.39	8	499550.231	3928962.697	

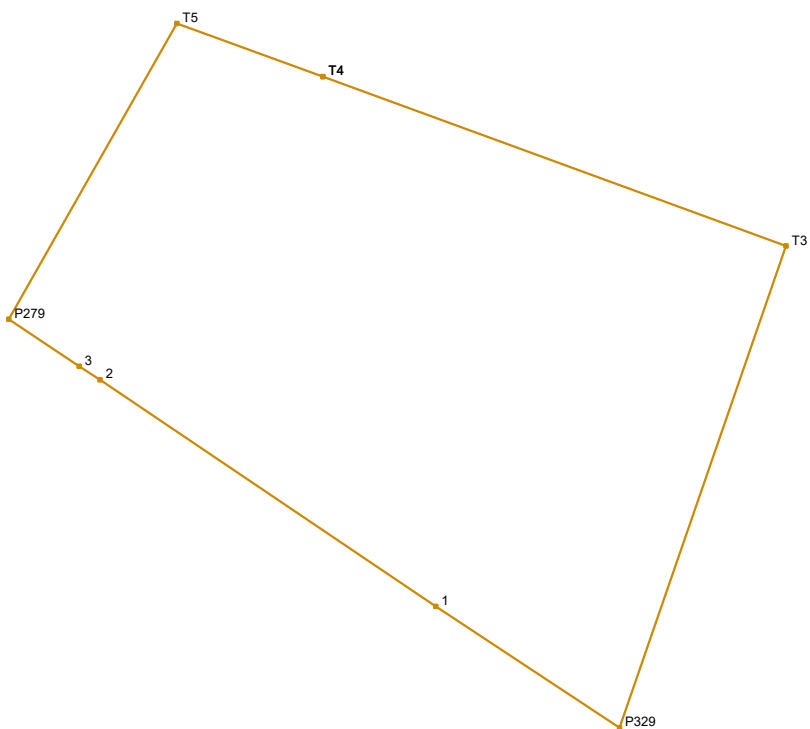

Νέα ιδιοκτησία εντός ΟΤ							
id1:1454		id2:01		Σημεία:8		Εμβαδό:197.99 m <sup>2</sup>	
Σημείο	X	Y	μήκος	Σημείο	X	Y	μήκος
T4	499606.253	3929104.377	12.88	3	499599.894	3929096.809	2.22
T3	499618.351	3929099.953		P279	499598.050	3929098.043	
P329	499614.002	3929087.370	13.31	T5	499602.444	3929105.770	8.89
1	499609.206	3929090.541	5.75	T4	499606.253	3929104.377	
2	499600.438	3929096.462	10.58				4.06
			0.65				

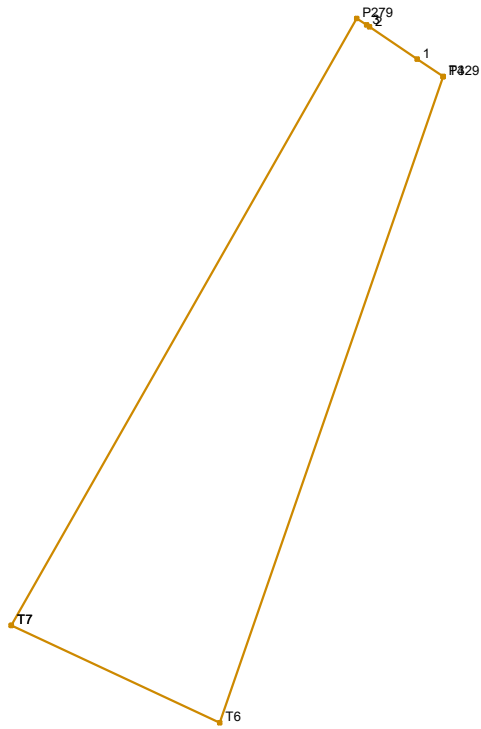

Νέα ιδιοκτησία εντός ΟΤ							
id1:1454		id2:02		Σημεία:8		Εμβαδό:3883.22 m <sup>2</sup>	
Σημείο	X	Y	μήκος	Σημείο	X	Y	μήκος
T7	499534.481	3928986.247	128.61	P329	499614.002	3929087.370	0.10
P279	499598.050	3929098.043	2.22	T4	499613.968	3929087.270	125.82
3	499599.894	3929096.809	0.65	T6	499572.871	3928968.355	42.35
2	499600.438	3929096.462	10.58	T7	499534.481	3928986.247	
1	499609.206	3929090.541	5.75				



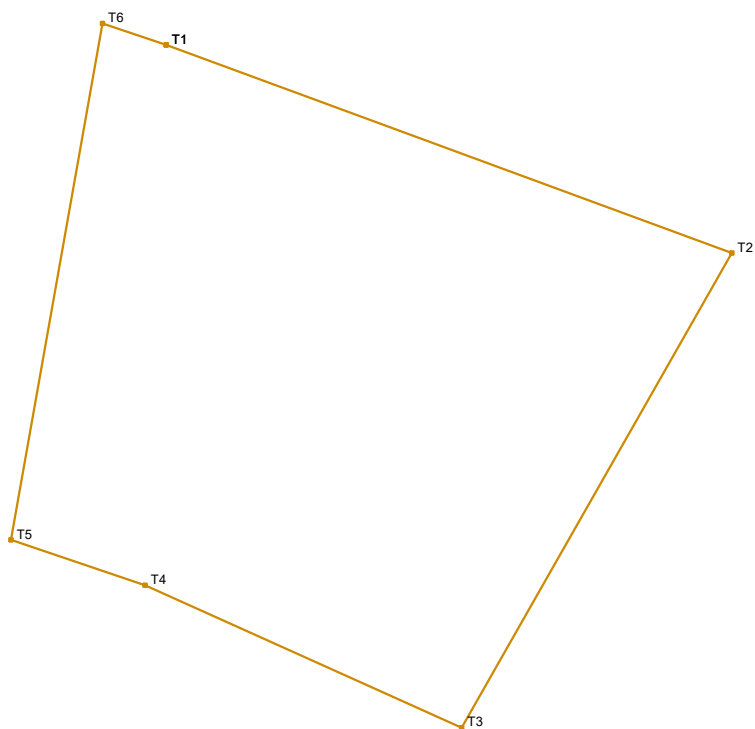

Νέα ιδιοκτησία εντός ΟΤ							
id1:1455		id2:01		Σημεία:6		Εμβαδό:3045.03 m <sup>2</sup>	
Σημείο	X	Y	μήκος	Σημείο	X	Y	μήκος
T1	499497.593	3929057.971	60.33	T5	499482.024	3929008.424	52.53
T2	499554.219	3929037.144	54.70	T6	499491.194	3929060.145	6.76
T3	499527.182	3928989.596	34.78	T1	499497.593	3929057.971	
T4	499495.460	3929003.862	14.19				

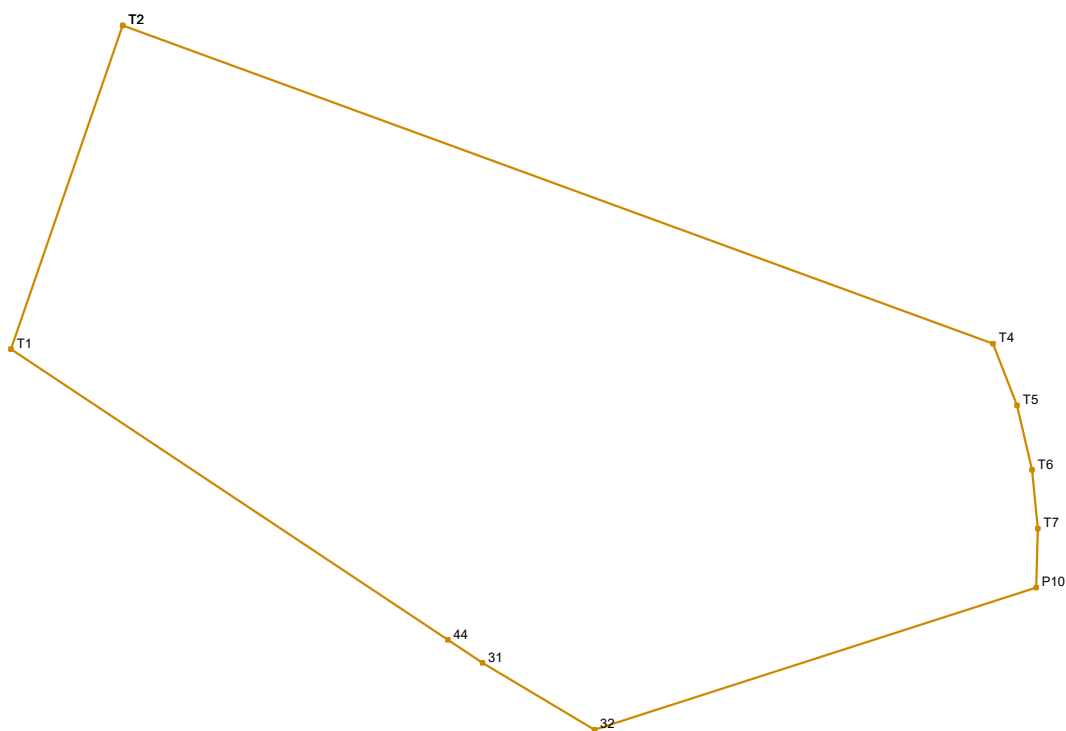

Νέα ιδιοκτησία εντός ΟΤ							
id1:1456		id2:01		Σημεία:10		Εμβαδό:769.42 m <sup>2</sup>	
Σημείο	X	Y	μήκος	Σημείο	X	Y	μήκος
T2	499623.987	3929097.892	40.22	32	499644.464	3929067.321	5.67
T4	499661.757	3929084.079		31	499639.600	3929070.230	1.80
T5	499662.793	3929081.396	2.88	44	499638.095	3929071.225	22.78
T6	499663.446	3929078.595	2.88	T1	499619.131	3929083.843	14.86
T7	499663.695	3929076.047	2.56	T2	499623.987	3929097.892	
P10	499663.636	3929073.492	2.56				
			20.14				

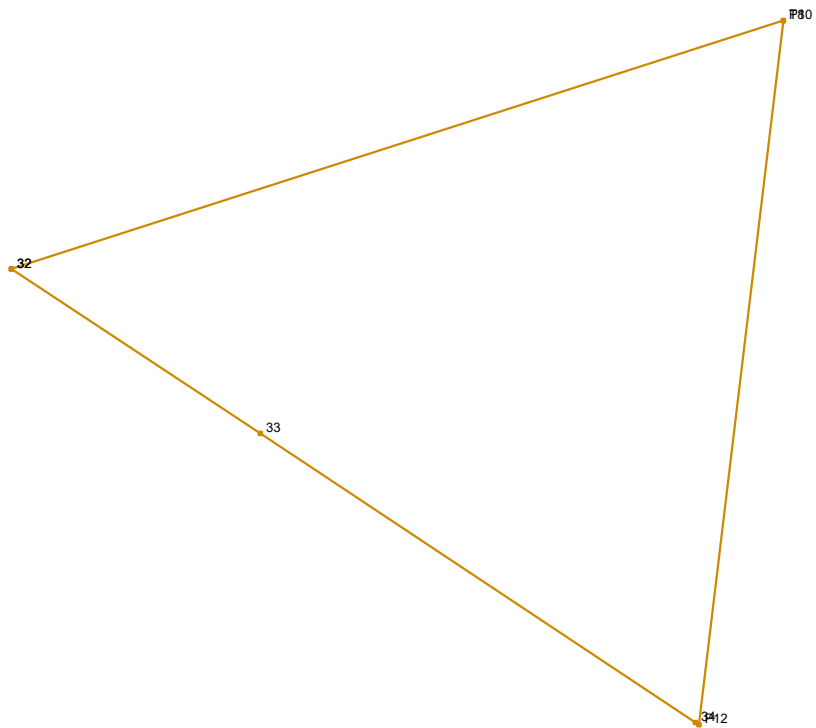

Νέα ιδιοκτησία εντός ΟΤ							
id1:1456		id2:02		Σημεία:6		Εμβαδό:161.06 m <sup>2</sup>	
Σημείο	X	Y	μήκος	Σημείο	X	Y	μήκος
32	499644.464	3929067.321	20.14	34	499661.453	3929056.057	12.97
P10	499663.636	3929073.492		0.01	33	499650.648	3929063.237
T8	499663.636	3929073.483	17.61	32	499644.464	3929067.321	
P12	499661.537	3929056.001	0.10				

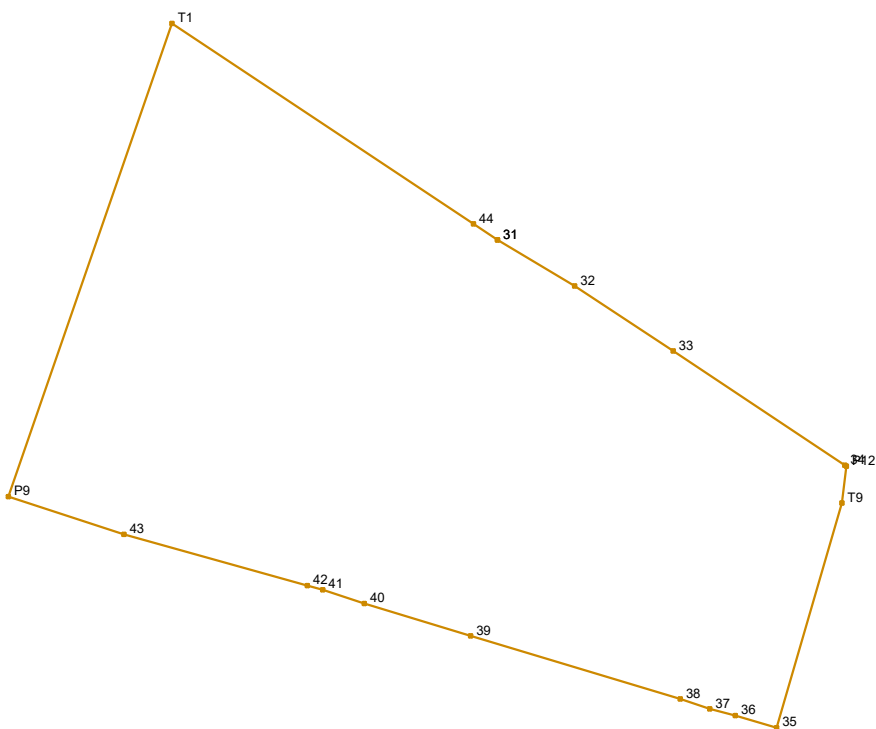

Νέα ιδιοκτησία εντός ΟΤ							
id1:1456		id2:03		Σημεία:18		Εμβαδό:1206.55 m <sup>2</sup>	
Σημείο	X	Y	μήκος	Σημείο	X	Y	μήκος
31	499639.600	3929070.230	5.67	39	499637.923	3929045.337	6.98
32	499644.464	3929067.321		7.41	40	499631.239	3929047.363
33	499650.648	3929063.237	12.97	41	499628.611	3929048.219	0.99
34	499661.453	3929056.057	0.10	42	499627.659	3929048.487	11.98
P12	499661.537	3929056.001	2.34	43	499616.118	3929051.711	7.65
T9	499661.258	3929053.676	14.71	P9	499608.848	3929054.088	31.48
35	499657.159	3929039.554	2.72	T1	499619.131	3929083.843	22.78
36	499654.554	3929040.327	1.65	44	499638.095	3929071.225	1.80
37	499652.958	3929040.732	1.96	31	499639.600	3929070.230	
38	499651.103	3929041.365	13.77				

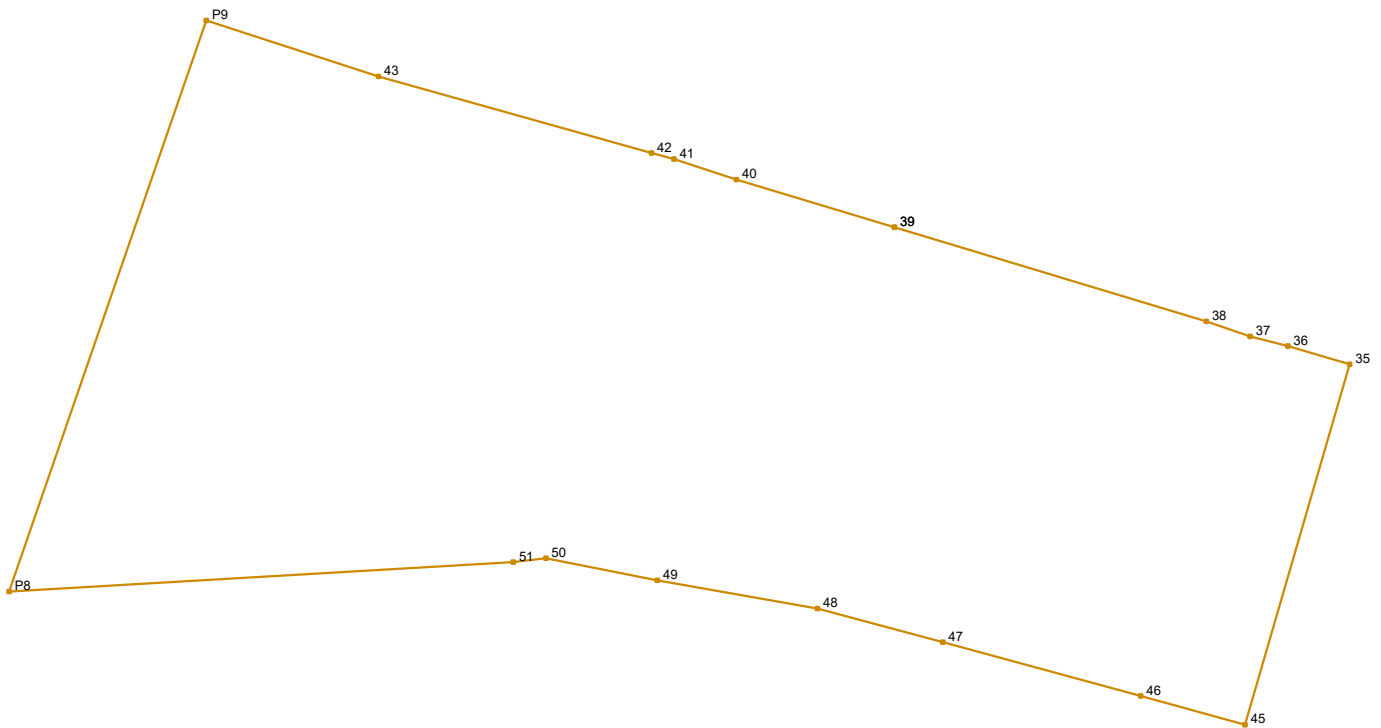

Νέα ιδιοκτησία εντός ΟΤ							
id1:1456		id2:04		Σημεία:18		Εμβαδό:943.71 m <sup>2</sup>	
Σημείο	X	Y	μήκος	Σημείο	X	Y	μήκος
39	499637.923	3929045.337		50	499623.194	3929031.354	
			13.77				1.39
38	499651.103	3929041.365		51	499621.815	3929031.200	
			1.96				21.34
37	499652.958	3929040.732		P8	499600.508	3929029.955	
			1.65				25.53
36	499654.554	3929040.327		P9	499608.848	3929054.088	
			2.72				7.65
35	499657.159	3929039.554		43	499616.118	3929051.711	
			15.86				11.98
45	499652.738	3929024.324		42	499627.659	3929048.487	
			4.58				0.99
46	499648.321	3929025.548		41	499628.611	3929048.219	
			8.66				2.76
47	499639.963	3929027.810		40	499631.239	3929047.363	
			5.48				6.98
48	499634.665	3929029.228		39	499637.923	3929045.337	
			6.86				
49	499627.906	3929030.420					
			4.80				

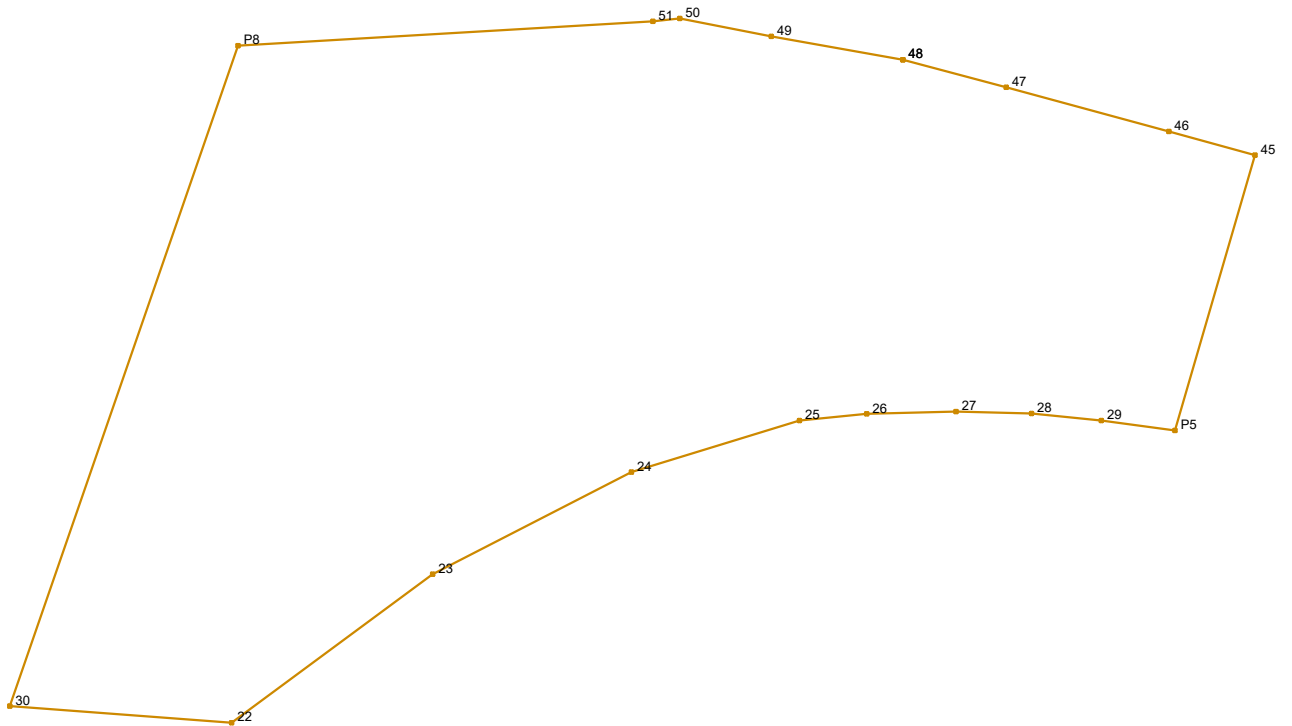

Νέα ιδιοκτησία εντός ΟΤ							
id1:1456		id2:05		Σημεία:18		Εμβαδό:1321.78 m <sup>2</sup>	
Σημείο	X	Y	μήκος	Σημείο	X	Y	μήκος
48	499634.665	3929029.228		24	499620.717	3929008.042	
			5.48				11.48
47	499639.963	3929027.810		23	499610.497	3929002.807	
			8.66				12.84
46	499648.321	3929025.548		22	499600.174	3928995.173	
			4.58				11.42
45	499652.738	3929024.324		30	499588.784	3928996.030	
			14.73				35.89
P5	499648.632	3929010.181		P8	499600.508	3929029.955	
			3.82				21.34
29	499644.847	3929010.688		51	499621.815	3929031.200	
			3.60				1.39
28	499641.265	3929011.063		50	499623.194	3929031.354	
			3.88				4.80
27	499637.382	3929011.163		49	499627.906	3929030.420	
			4.59				6.86
26	499632.795	3929011.038		48	499634.665	3929029.228	
			3.46				
25	499629.354	3929010.688					
			9.03				

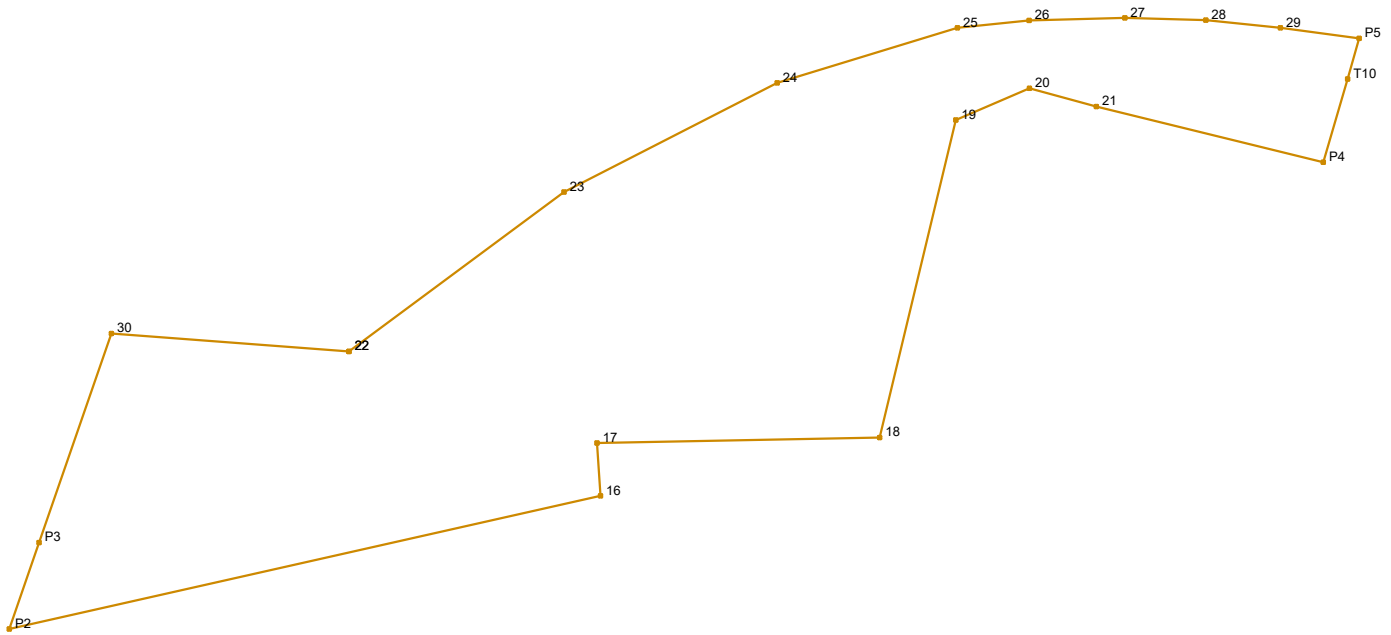

Νέα ιδιοκτησία εντός ΟΤ							
id1:1456		id2:06		Σημεία:20		Εμβαδό:660.32 m <sup>2</sup>	
Σημείο	X	Y	μήκος	Σημείο	X	Y	μήκος
22	499600.174	3928995.173		21	499636.015	3929006.914	
			12.84				3.32
23	499610.497	3929002.807		20	499632.809	3929007.790	
			11.48				3.85
24	499620.717	3929008.042		19	499629.277	3929006.269	
			9.03				15.67
25	499629.354	3929010.688		18	499625.626	3928991.034	
			3.46				13.55
26	499632.795	3929011.038		17	499612.077	3928990.772	
			4.59				2.53
27	499637.382	3929011.163		16	499612.237	3928988.244	
			3.88				29.06
28	499641.265	3929011.063		P2	499583.884	3928981.852	
			3.60				4.39
29	499644.847	3929010.688		P3	499585.318	3928986.003	
			3.82				10.61
P5	499648.632	3929010.181		30	499588.784	3928996.030	
			2.02				11.42
T10	499648.069	3929008.240		22	499600.174	3928995.173	
			4.16				
P4	499646.903	3929004.248					
			11.21				

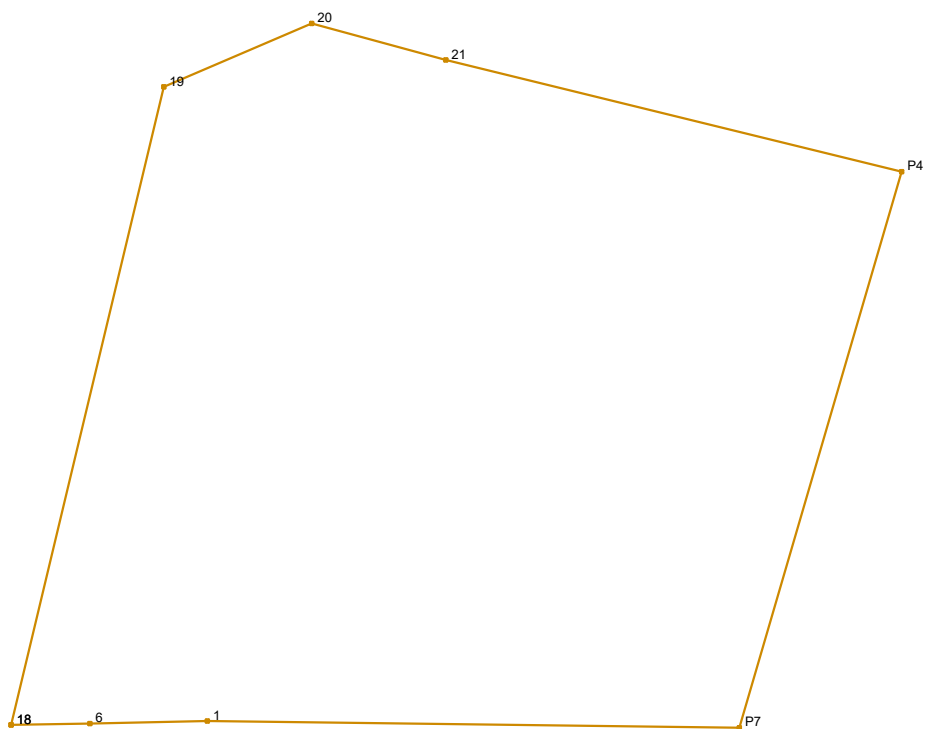

Νέα ιδιοκτησία εντός ΟΤ							
id1:1456		id2:07		Σημεία:8		Εμβαδό:269.20 m <sup>2</sup>	
Σημείο	X	Y	μήκος	Σημείο	X	Y	μήκος
18	499625.626	3928991.034	15.67	P7	499643.023	3928990.963	12.71
19	499629.277	3929006.269		1	499630.315	3928991.125	2.80
20	499632.809	3929007.790	3.85	6	499627.514	3928991.062	1.89
21	499636.015	3929006.914	3.32	18	499625.626	3928991.034	
P4	499646.903	3929004.248	11.21				
			13.84				





Νέα ιδιοκτησία εντός ΟΤ							
id1:1456		id2:08		Σημεία:8		Εμβαδό:221.54 m <sup>2</sup>	
Σημείο	X	Y	μήκος	Σημείο	X	Y	μήκος
1	499630.315	3928991.125	12.71	4	499627.953	3928977.563	1.22
P7	499643.023	3928990.963		17.07	5	499627.986	3928978.785
P6	499638.238	3928974.577	1.50	6	499627.514	3928991.062	2.80
2	499637.818	3928973.137	9.84	1	499630.315	3928991.125	
3	499628.014	3928974.028	3.54				

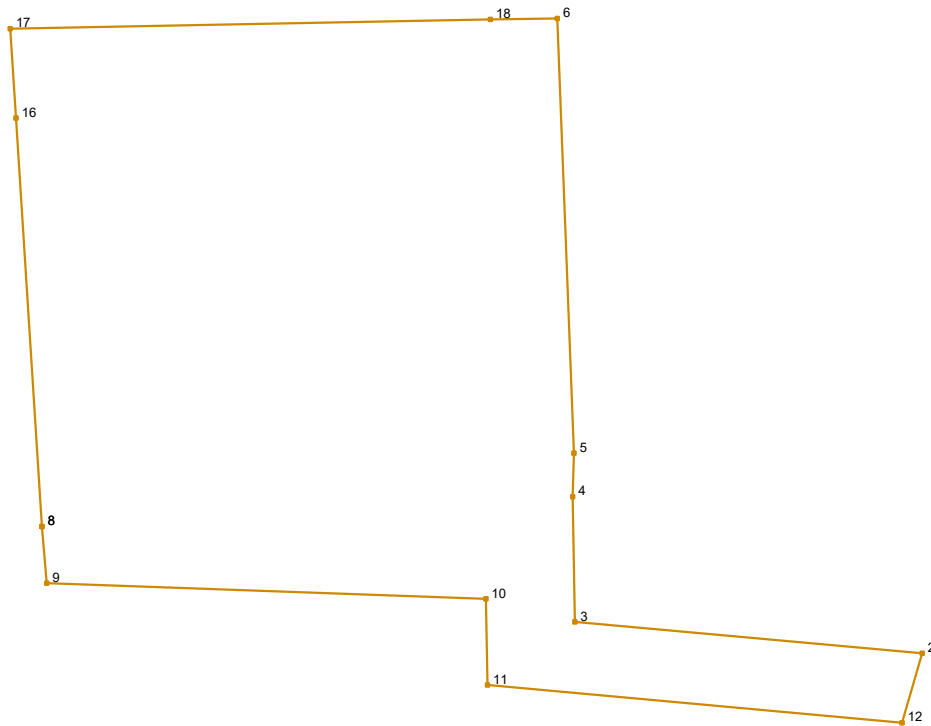

Νέα ιδιοκτησία εντός ΟΤ							
id1:1456		id2:09		Σημεία:13		Εμβαδό:270.02 m <sup>2</sup>	
Σημείο	X	Y	μήκος	Σημείο	X	Y	μήκος
8	499612.967	3928976.720	11.55	3	499628.014	3928974.028	9.84
16	499612.237	3928988.244	2.53	2	499637.818	3928973.137	2.04
17	499612.077	3928990.772	13.55	12	499637.246	3928971.181	11.75
18	499625.626	3928991.034	1.89	11	499625.544	3928972.244	2.43
6	499627.514	3928991.062	12.29	10	499625.502	3928974.677	12.41
5	499627.986	3928978.785	1.22	9	499613.104	3928975.119	1.61
4	499627.953	3928977.563	3.54	8	499612.967	3928976.720	

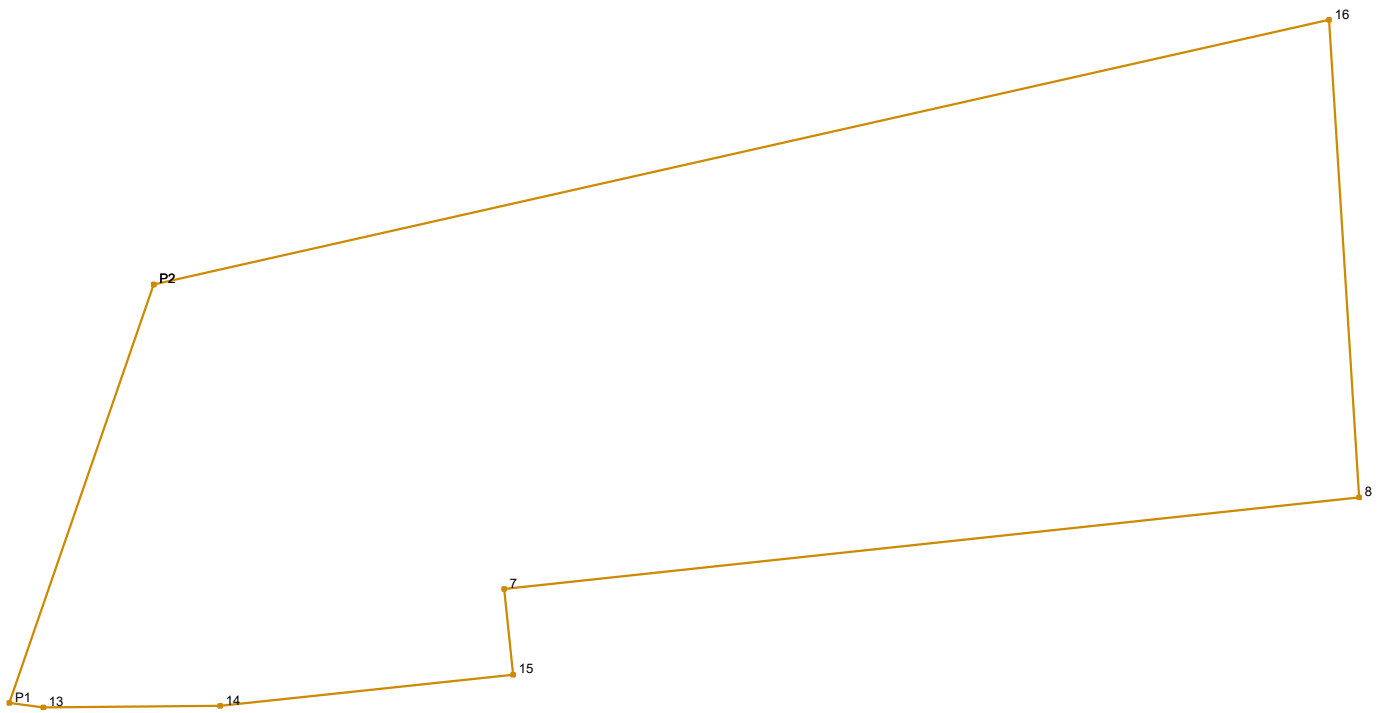

Νέα ιδιοκτησία εντός ΟΤ							
id1:1456		id2:10		Σημεία:8		Εμβαδό:321.24 m <sup>2</sup>	
Σημείο	X	Y	μήκος	Σημείο	X	Y	μήκος
P2	499583.884	3928981.852		14	499585.490	3928971.691	
			29.06				4.28
16	499612.237	3928988.244		13	499581.214	3928971.653	
			11.55				0.82
8	499612.967	3928976.720		P1	499580.397	3928971.764	
			20.75				10.67
7	499592.336	3928974.514		P2	499583.884	3928981.852	
			2.08				
15	499592.556	3928972.441					
			7.11				

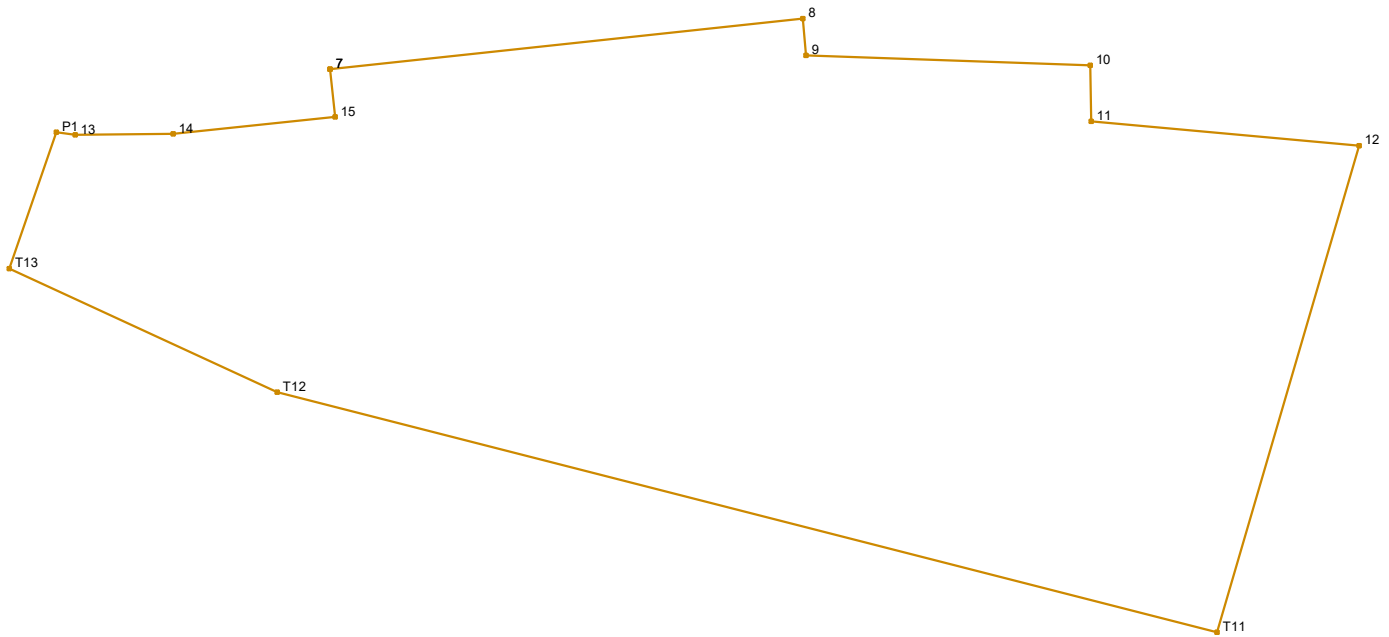

Νέα ιδιοκτησία εντός ΟΤ							
id1:1456		id2:11		Σημεία:13		Εμβαδό:964.34 m <sup>2</sup>	
Σημείο	X	Y	μήκος	Σημείο	X	Y	μήκος
7	499592.336	3928974.514	20.75	T12	499590.029	3928960.416	12.88
8	499612.967	3928976.720		T13	499578.343	3928965.820	6.29
9	499613.104	3928975.119	1.61	P1	499580.397	3928971.764	0.82
10	499625.502	3928974.677	12.41	13	499581.214	3928971.653	4.28
11	499625.544	3928972.244	2.43	14	499585.490	3928971.691	7.11
12	499637.246	3928971.181	11.75	15	499592.556	3928972.441	2.08
T11	499631.044	3928949.942	22.13	7	499592.336	3928974.514	
			42.33				

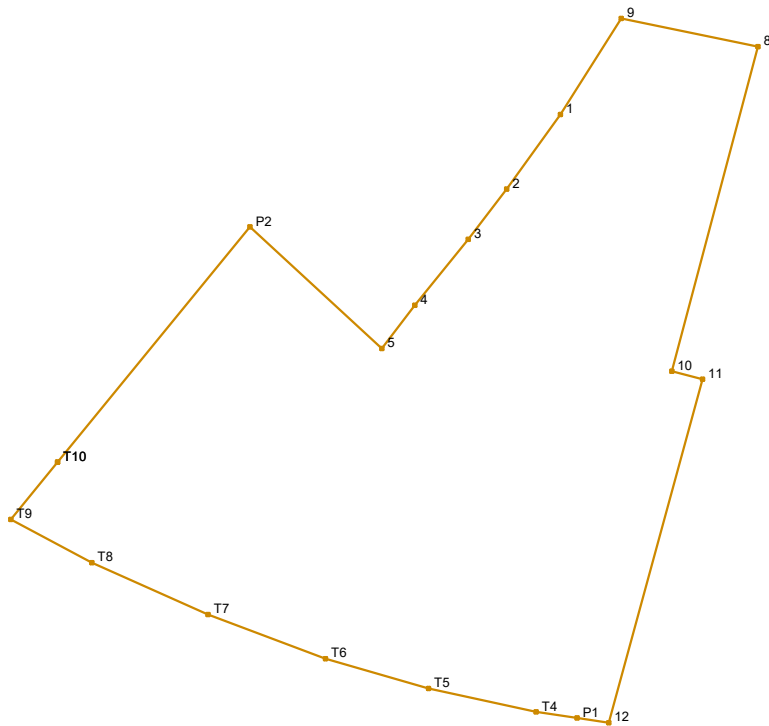

Νέα ιδιοκτησία εντός ΟΤ							
id1:1458		id2:01		Σημεία:19		Εμβαδό:801.17 m <sup>2</sup>	
Σημείο	X	Y	μήκος	Σημείο	X	Y	μήκος
T10	499376.625	3928933.007		11	499412.110	3928937.555	19.58
P2	499387.205	3928945.948	16.72	12	499406.956	3928918.663	1.76
5	499394.458	3928939.253	9.87	P1	499405.213	3928918.921	2.29
4	499396.280	3928941.636	3.00	T4	499402.948	3928919.257	6.05
3	499399.225	3928945.251	4.66	T5	499397.034	3928920.543	5.91
2	499401.338	3928948.018	3.48	T6	499391.354	3928922.183	6.90
1	499404.296	3928952.120	5.06	T7	499384.892	3928924.614	7.00
9	499407.641	3928957.420	6.27	T8	499378.498	3928927.464	5.05
8	499415.151	3928955.862	7.67	T9	499374.045	3928929.851	4.08
10	499410.418	3928938.004	18.47	T10	499376.625	3928933.007	
			1.75				

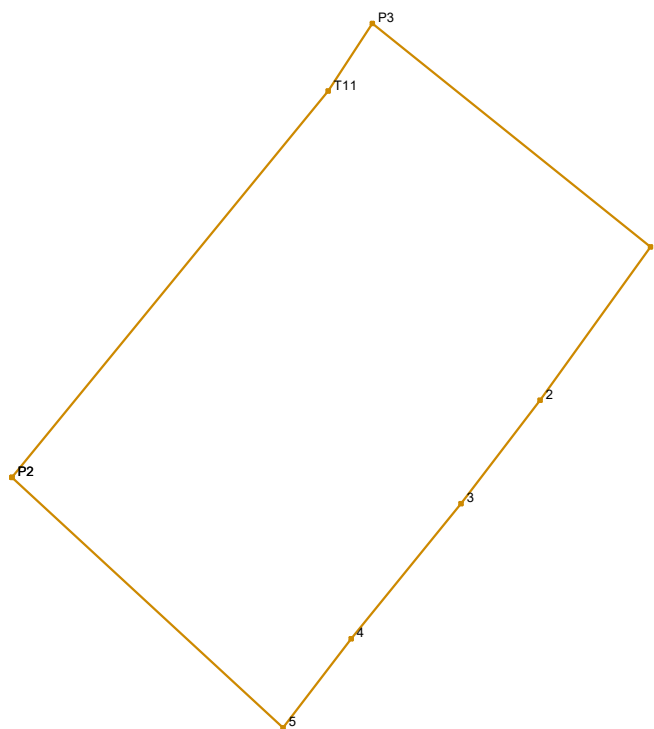

Νέα ιδιοκτησία εντός ΟΤ							
id1:1458		id2:02		Σημεία:8		Εμβαδό:153.39 m <sup>2</sup>	
Σημείο	X	Y	μήκος	Σημείο	X	Y	μήκος
P2	499387.205	3928945.948	13.36	3	499399.225	3928945.251	4.66
T11	499395.664	3928956.295		4	499396.280	3928941.636	
P3	499396.850	3928958.104	9.55	5	499394.458	3928939.253	9.87
1	499404.296	3928952.120		2	499401.338	3928948.018	
2	499401.338	3928948.018	5.06				
			3.48				

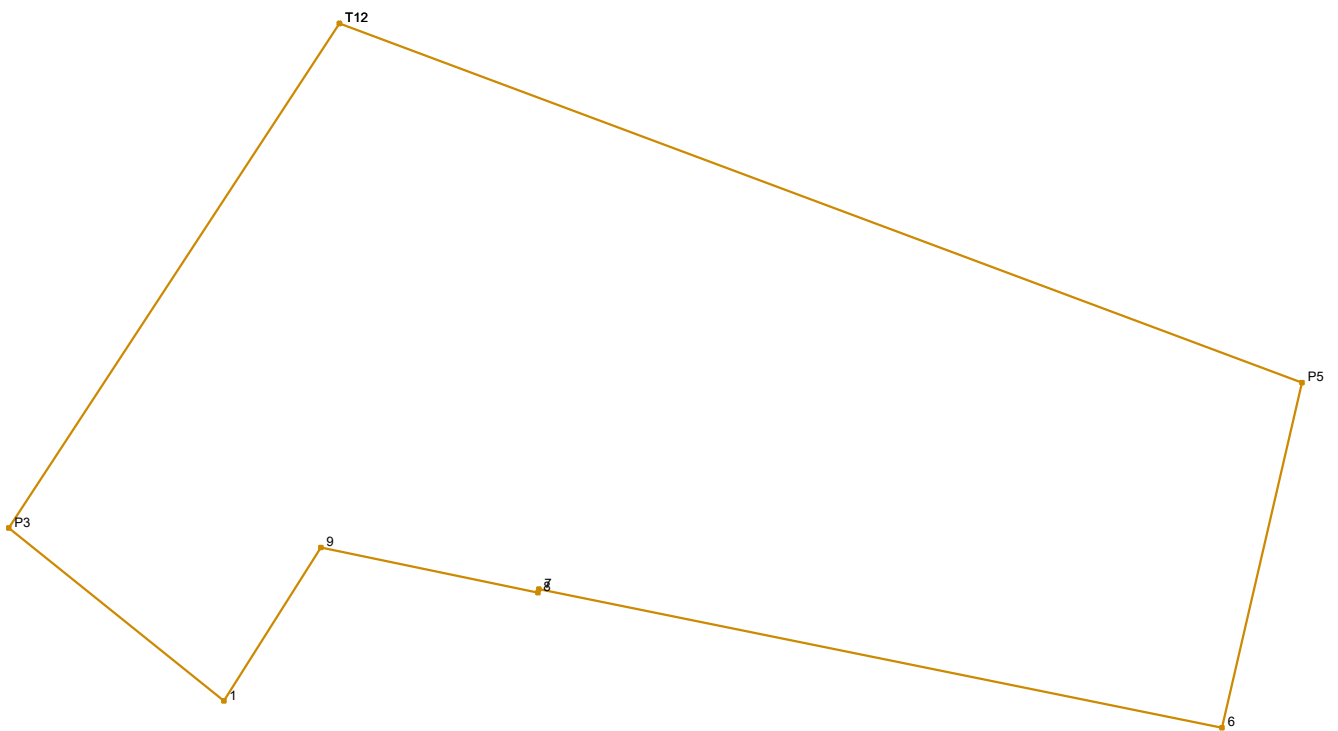

Νέα ιδιοκτησία εντός ΟΤ							
id1:1458		id2:03		Σημεία:8		Εμβαδό:627.47 m <sup>2</sup>	
Σημείο	X	Y	μήκος	Σημείο	X	Y	μήκος
T12	499408.291	3928975.551	35.52	9	499407.641	3928957.420	6.27
P5	499441.567	3928963.129		1	499404.296	3928952.120	
6	499438.808	3928951.194	12.25	P3	499396.850	3928958.104	20.86
7	499415.183	3928955.983	24.11	T12	499408.291	3928975.551	
8	499415.151	3928955.862	0.13				
			7.67				

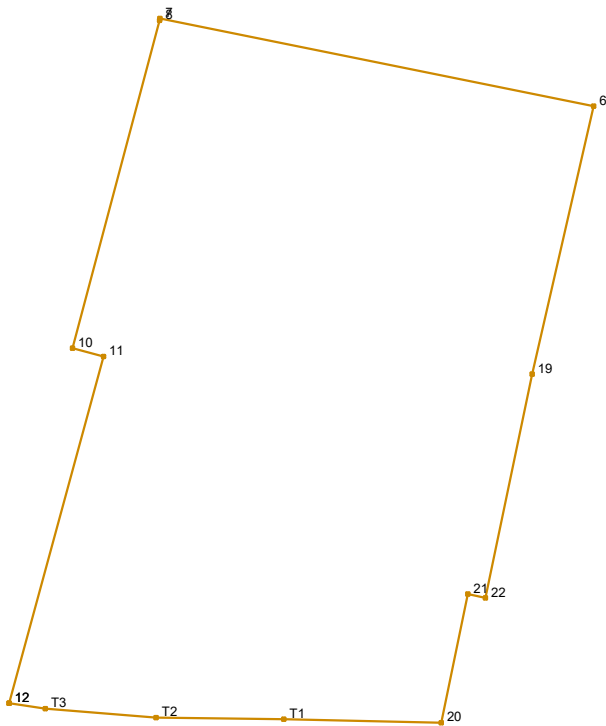

Νέα ιδιοκτησία εντός ΟΤ							
id1:1458		id2:04		Σημεία:13		Εμβαδό:870.35 m <sup>2</sup>	
Σημείο	X	Y	μήκος	Σημείο	X	Y	μήκος
12	499406.956	3928918.663	19.58	22	499432.924	3928924.403	0.98
11	499412.110	3928937.555	1.75	21	499431.961	3928924.604	7.15
10	499410.418	3928938.004	18.47	20	499430.503	3928917.599	8.57
8	499415.151	3928955.862	0.13	T1	499421.933	3928917.793	6.97
7	499415.183	3928955.983	24.11	T2	499414.966	3928917.885	6.05
6	499438.808	3928951.194	14.97	T3	499408.934	3928918.370	2.00
19	499435.463	3928936.599	12.46	12	499406.956	3928918.663	



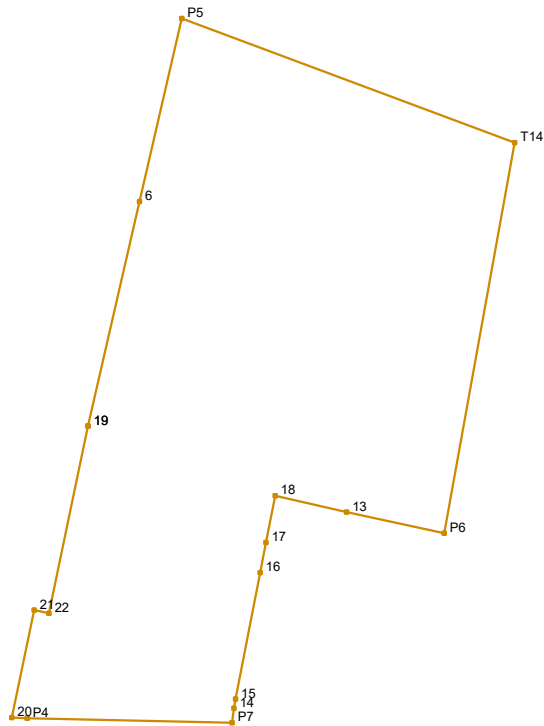

Νέα ιδιοκτησία εντός ΟΤ							
id1:1458		id2:05		Σημεία:16		Εμβαδό:864.02 m <sup>2</sup>	
Σημείο	X	Y	μήκος	Σημείο	X	Y	μήκος
19	499435.463	3928936.599		15	499445.071	3928918.808	
			14.97				0.60
6	499438.808	3928951.194		14	499444.956	3928918.221	
			12.25				0.95
P5	499441.567	3928963.129		P7	499444.847	3928917.276	
			23.14				13.35
T14	499463.249	3928955.036		P4	499431.503	3928917.577	
			25.83				1.00
P6	499458.658	3928929.618		20	499430.503	3928917.599	
			6.51				7.15
13	499452.289	3928930.990		21	499431.961	3928924.604	
			4.76				0.98
18	499447.647	3928932.055		22	499432.924	3928924.403	
			3.10				12.46
17	499447.055	3928929.012		19	499435.463	3928936.599	
			2.00				
16	499446.673	3928927.049					
			8.40				

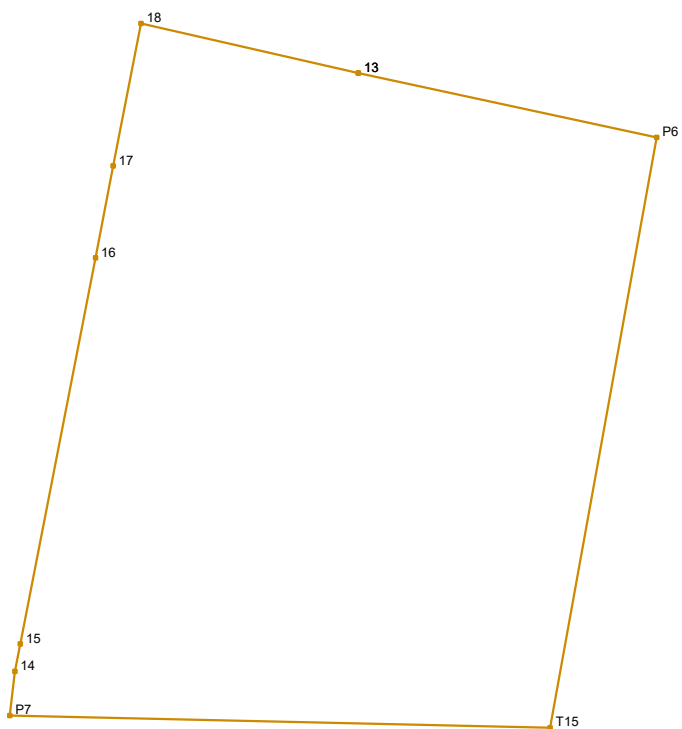

Νέα ιδιοκτησία εντός ΟΤ							
id1:1458		id2:06		Σημεία:9		Εμβαδό:158.07 m <sup>2</sup>	
Σημείο	X	Y	μήκος	Σημείο	X	Y	μήκος
13	499452.289	3928930.990	6.51	15	499445.071	3928918.808	8.40
P6	499458.658	3928929.618		12.81	16	499446.673	3928927.049
T15	499456.382	3928917.016	11.54	17	499447.055	3928929.012	3.10
P7	499444.847	3928917.276	0.95	18	499447.647	3928932.055	4.76
14	499444.956	3928918.221	0.60	13	499452.289	3928930.990	

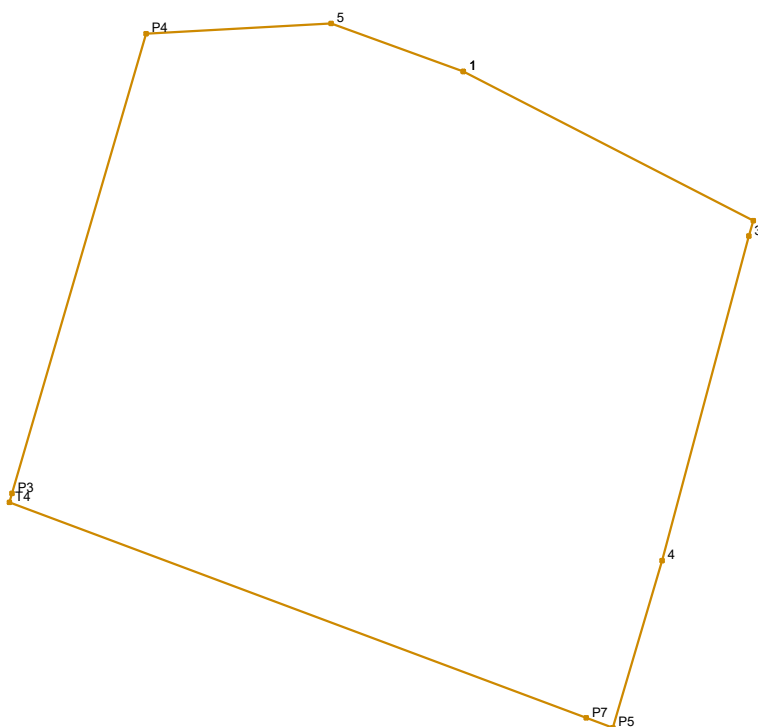

Νέα ιδιοκτησία εντός ΟΤ							
id1:1459		id2:01		Σημεία:10		Εμβαδό:468.76 m <sup>2</sup>	
Σημείο	X	Y	μήκος	Σημείο	X	Y	μήκος
1	499428.080	3928996.610		T4	499411.414	3928980.789	
			11.96				0.34
2	499438.720	3928991.140		P3	499411.510	3928981.119	
			0.59				17.58
3	499438.560	3928990.570		P4	499416.438	3928997.994	
			12.33				6.79
4	499435.370	3928978.660		5	499423.220	3928998.380	
			6.40				5.17
P5	499433.561	3928972.522		1	499428.080	3928996.610	
			1.03				
P7	499432.596	3928972.883					
			22.61				

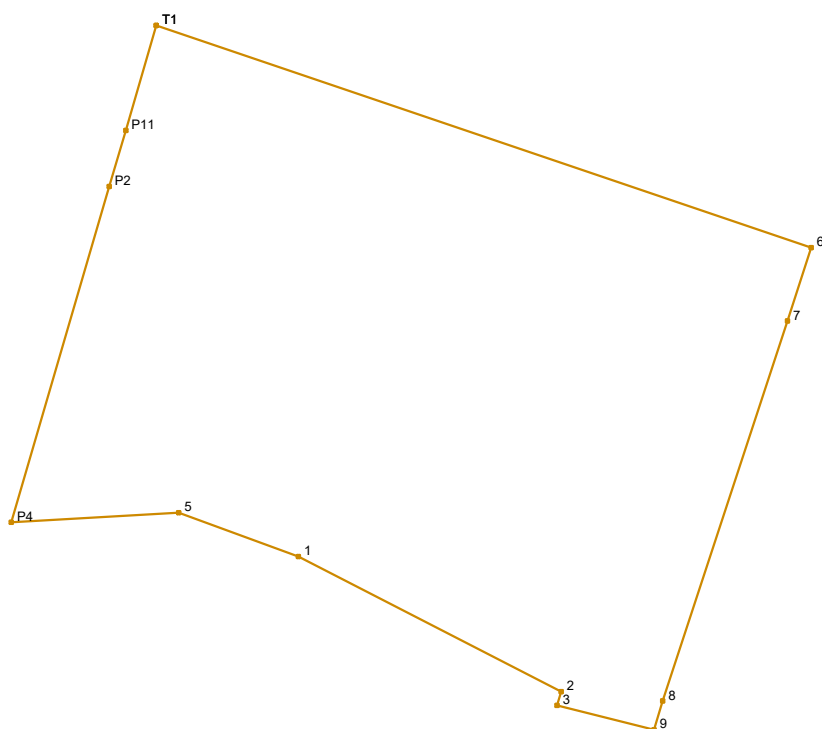

Νέα ιδιοκτησία εντός ΟΤ							
id1:1459		id2:02		Σημεία:12		Εμβαδό:540.11 m <sup>2</sup>	
Σημείο	X	Y	μήκος	Σημείο	X	Y	μήκος
T1	499422.321	3929018.135	28.03	1	499428.080	3928996.610	5.17
6	499448.862	3929009.123		5	499423.220	3928998.380	
7	499447.890	3929006.160	3.12	P4	499416.438	3928997.994	14.18
8	499442.840	3928990.760		16.21	P2	499420.414	
9	499442.480	3928989.590	1.22	P11	499421.078	3929013.878	4.43
3	499438.560	3928990.570		4.04	T1	499422.321	
2	499438.720	3928991.140	0.59				
			11.96				

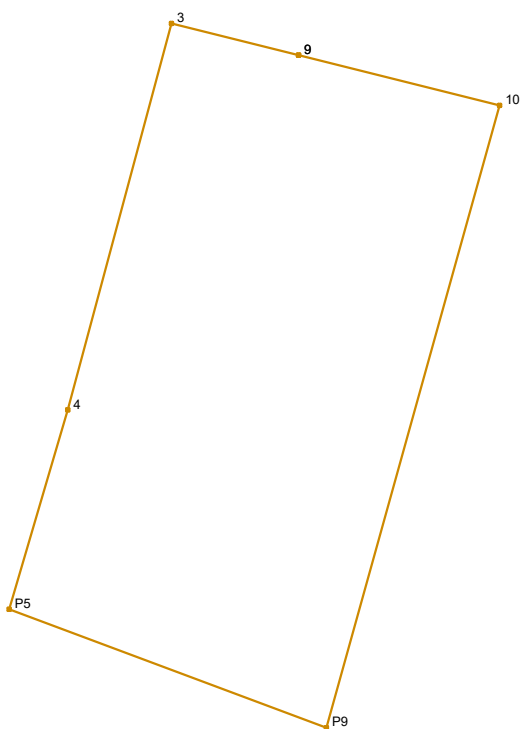

Νέα ιδιοκτησία εντός ΟΤ							
id1:1459		id2:03		Σημεία:6		Εμβαδό:200.03 m <sup>2</sup>	
Σημείο	X	Y	μήκος	Σημείο	X	Y	μήκος
9	499442.480	3928989.590	6.38	4	499435.370	3928978.660	12.33
10	499448.670	3928988.040		19.90	3	499438.560	
P9	499443.340	3928968.872	10.44	9	499442.480	3928989.590	4.04
P5	499433.561	3928972.522	6.40				

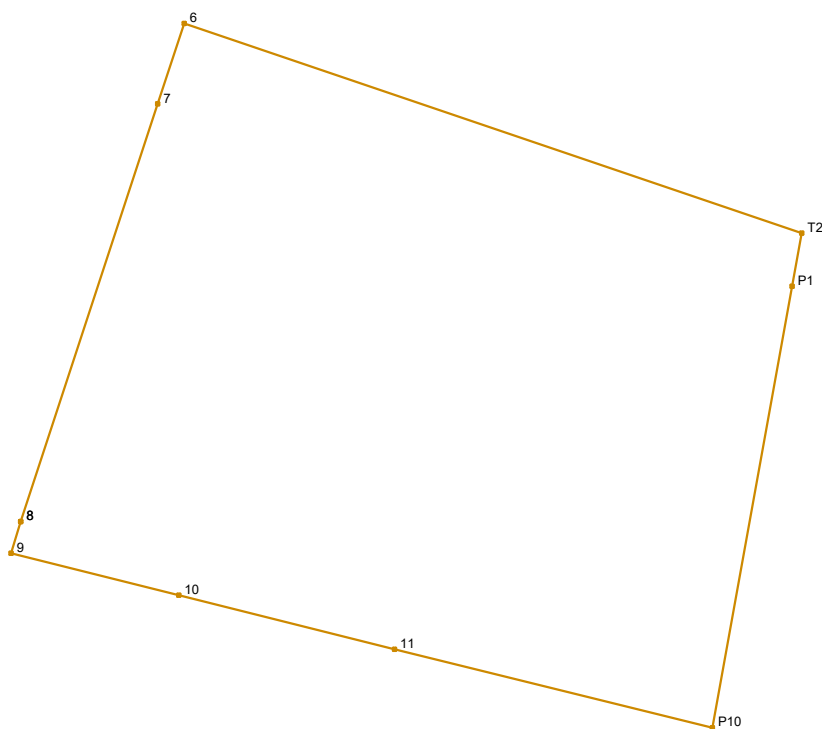

Νέα ιδιοκτησία εντός ΟΤ							
id1:1459		id2:04		Σημεία:9		Εμβαδό:493.74 m <sup>2</sup>	
Σημείο	X	Y	μήκος	Σημείο	X	Y	μήκος
8	499442.840	3928990.760	16.21	P10	499468.329	3928983.160	12.06
7	499447.890	3929006.160	3.12	11	499456.620	3928986.050	8.20
6	499448.862	3929009.123	24.04	10	499448.670	3928988.040	6.38
T2	499471.623	3929001.395	2.00	9	499442.480	3928989.590	1.22
P1	499471.268	3928999.431	16.53	8	499442.840	3928990.760	

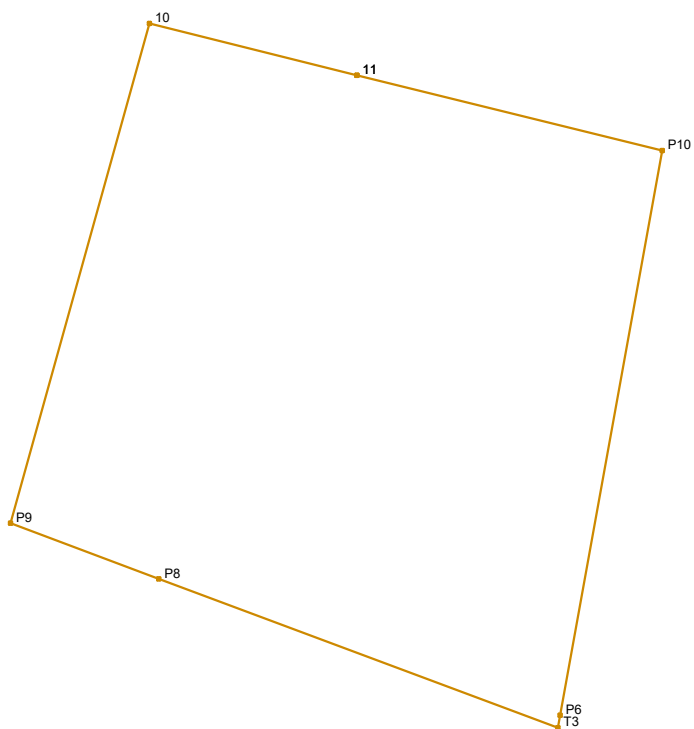

Νέα ιδιοκτησία εντός ΟΤ							
id1:1459		id2:05		Σημεία:7		Εμβαδό:449.14 m <sup>2</sup>	
Σημείο	X	Y	μήκος	Σημείο	X	Y	μήκος
11	499456.620	3928986.050	12.06	P8	499449.029	3928966.748	6.07
P10	499468.329	3928983.160		22.00	P9	499443.340	3928968.872
P6	499464.420	3928961.515	0.49		10	499448.670	3928988.040
T3	499464.333	3928961.036	16.34	11	499456.620	3928986.050	

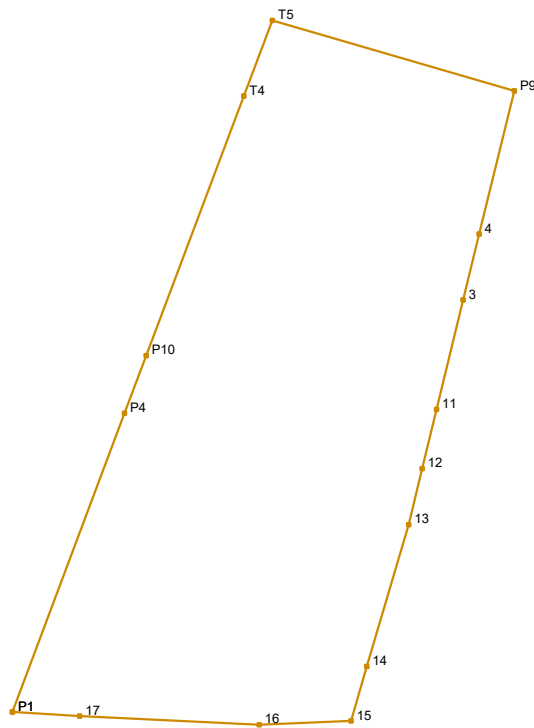

Νέα ιδιοκτησία εντός ΟΤ							
id1:1460		id2:01N		Σημεία:15		Εμβαδό:500.96 m <sup>2</sup>	
Σημείο	X	Y	μήκος	Σημείο	X	Y	μήκος
P1	499426.400	3929041.534	15.83	11	499447.450	3929056.536	3.01
P4	499431.973	3929056.351	3.06	12	499446.740	3929053.609	2.86
P10	499433.049	3929059.214	13.76	13	499446.067	3929050.831	7.35
T4	499437.895	3929072.097	4.01	14	499443.998	3929043.782	2.81
T5	499439.307	3929075.851	12.51	15	499443.206	3929041.083	4.55
P9	499451.311	3929072.347	7.31	16	499438.655	3929040.896	8.92
4	499449.567	3929065.247	3.37	17	499429.748	3929041.332	3.35
3	499448.770	3929061.968	5.59	P1	499426.400	3929041.534	



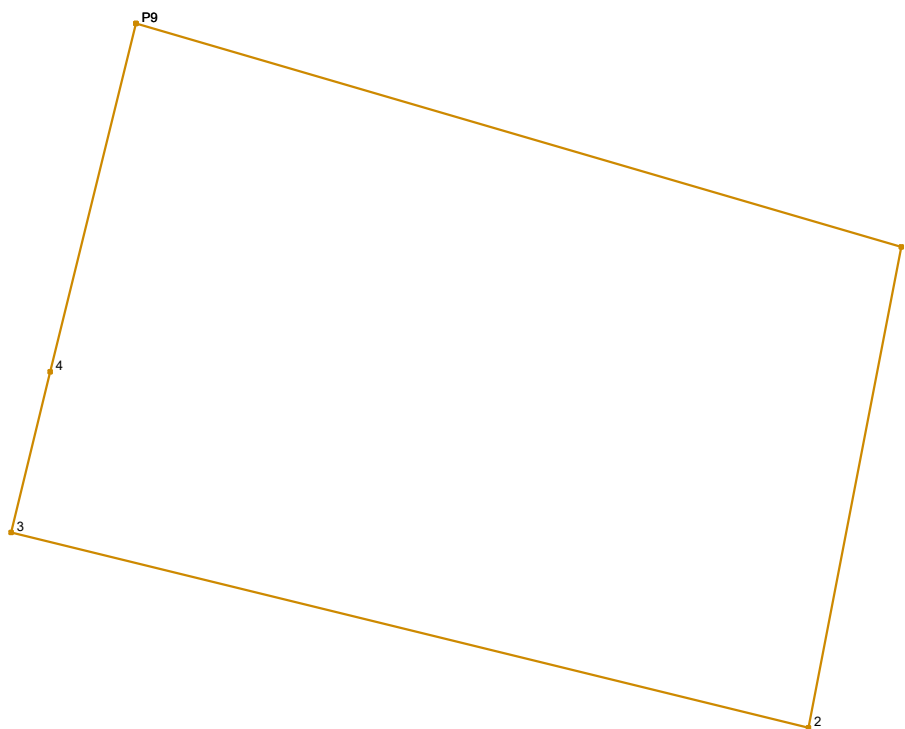

Νέα ιδιοκτησία εντός ΟΤ							
id1:1460		id2:02		Σημεία:5		Εμβαδό:170.22 m <sup>2</sup>	
Σημείο	X	Y	μήκος	Σημείο	X	Y	μήκος
P9	499451.311	3929072.347	16.26	3	499448.770	3929061.968	3.37
1	499466.916	3929067.791		9.98	4	499449.567	3929065.247
2	499465.025	3929057.989	16.73	P9	499451.311	3929072.347	

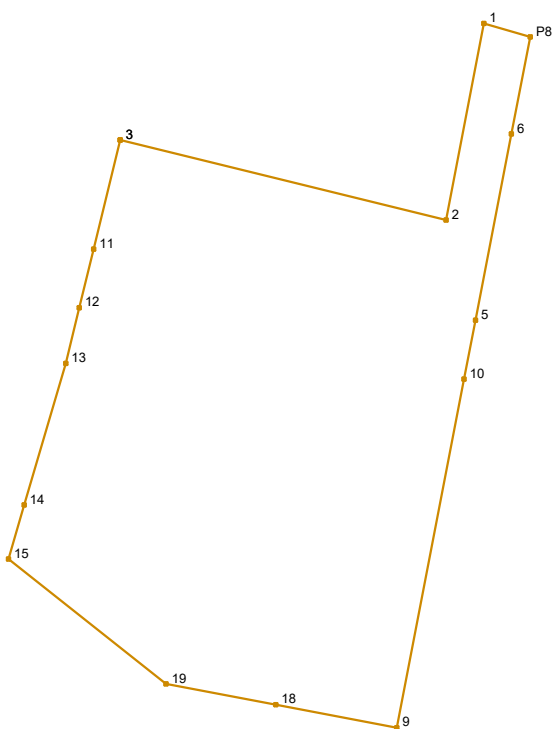

Νέα ιδιοκτησία εντός ΟΤ							
id1:1460		id2:03N		Σημεία:15		Εμβαδό:514.51 m <sup>2</sup>	
Σημείο	X	Y	μήκος	Σημείο	X	Y	μήκος
3	499448.770	3929061.968	16.73	18	499456.538	3929033.821	5.58
2	499465.025	3929057.989		9.98	19	499451.054	3929034.864
1	499466.916	3929067.791	2.40	15	499443.206	3929041.083	2.81
P8	499469.217	3929067.119	4.93	14	499443.998	3929043.782	7.35
6	499468.282	3929062.274	9.45	13	499446.067	3929050.831	2.86
5	499466.492	3929052.996	3.00	12	499446.740	3929053.609	3.01
10	499465.924	3929050.047	17.69	11	499447.450	3929056.536	5.59
9	499462.573	3929032.673	6.14	3	499448.770	3929061.968	

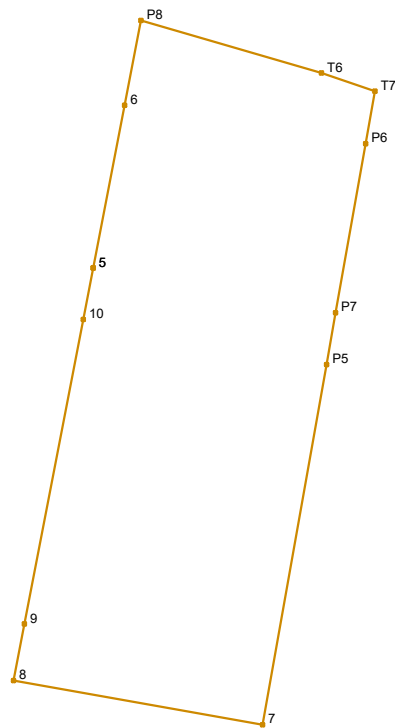

Νέα ιδιοκτησία εντός ΟΤ							
id1:1460		id2:04N		Σημεία:12		Εμβαδό:532.16 m <sup>2</sup>	
Σημείο	X	Y	μήκος	Σημείο	X	Y	μήκος
5	499466.492	3929052.996	9.45	P5	499479.807	3929047.470	20.87
6	499468.282	3929062.274	4.93	7	499476.162	3929026.917	14.44
P8	499469.217	3929067.119	10.73	8	499461.948	3929029.437	3.30
T6	499479.519	3929064.111	3.23	9	499462.573	3929032.673	17.69
T7	499482.573	3929063.074	3.04	10	499465.924	3929050.047	3.00
P6	499482.043	3929060.085	9.81	5	499466.492	3929052.996	
P7	499480.330	3929050.423	3.00				

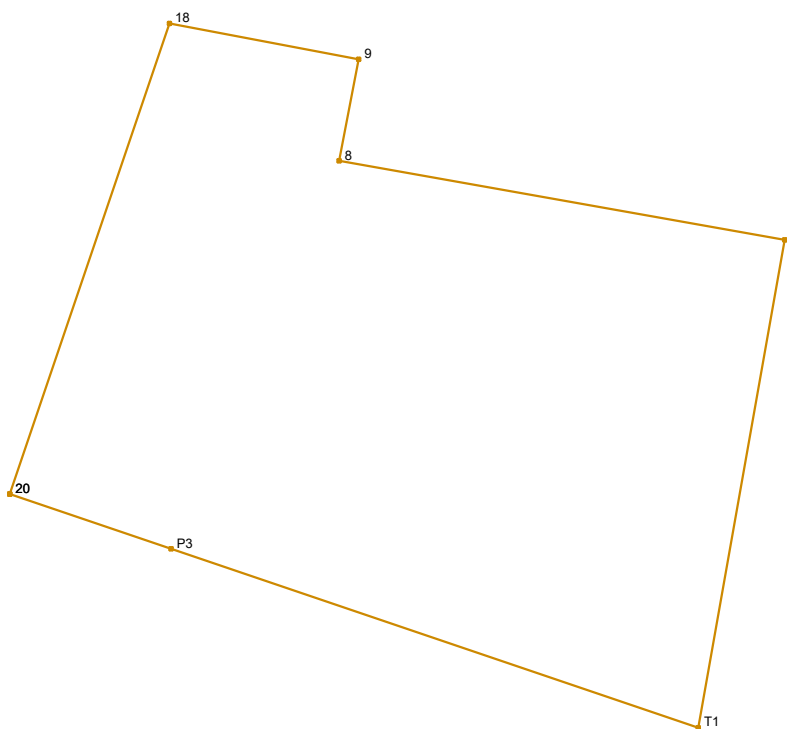

Νέα ιδιοκτησία εντός ΟΤ							
id1:1460		id2:05		Σημεία:7		Εμβαδό:331.90 m <sup>2</sup>	
Σημείο	X	Y	μήκος	Σημείο	X	Y	μήκος
20	499451.440	3929018.808	15.85	7	499476.162	3929026.917	15.81
18	499456.538	3929033.821	6.14	T1	499473.403	3929011.351	17.76
9	499462.573	3929032.673	3.30	P3	499456.584	3929017.062	5.43
8	499461.948	3929029.437	14.44	20	499451.440	3929018.808	

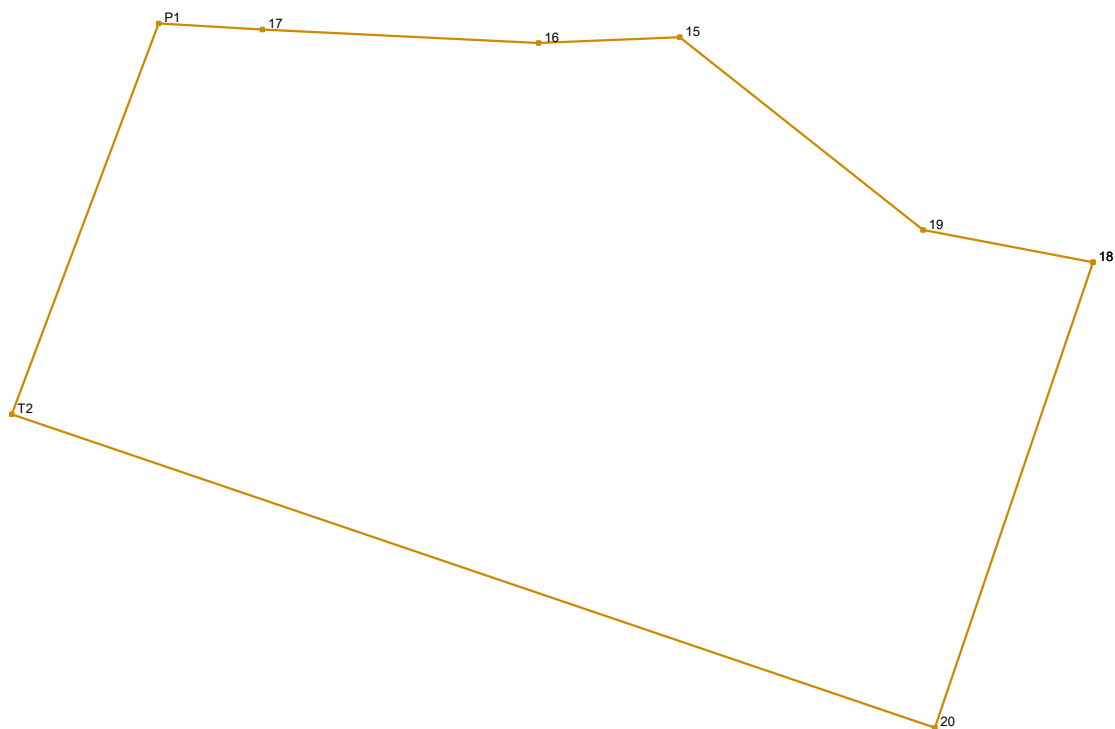

Νέα ιδιοκτησία εντός ΟΤ							
id1:1460		id2:06		Σημεία:8		Εμβαδό:500.00 m <sup>2</sup>	
Σημείο	X	Y	μήκος	Σημείο	X	Y	μήκος
18	499456.538	3929033.821	15.85	16	499438.655	3929040.896	4.55
20	499451.440	3929018.808		10.01			
T2	499421.656	3929028.921	13.48	19	499451.054	3929034.864	5.58
P1	499426.400	3929041.534		3.35			
17	499429.748	3929041.332	8.92	18	499456.538	3929033.821	

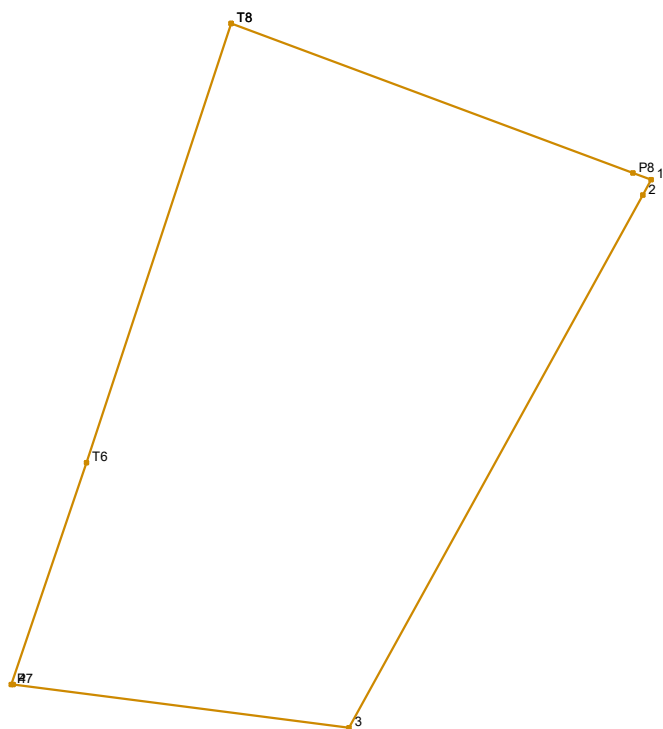

Νέα ιδιοκτησία εντός ΟΤ							
id1:1461		id2:01		Σημεία:8		Εμβαδό:521.38 m <sup>2</sup>	
Σημείο	X	Y	μήκος	Σημείο	X	Y	μήκος
T8	499467.577	3929162.446	19.39	4	499457.714	3929132.531	0.09
P8	499485.747	3929155.680		0.89	P7	499457.622	3929132.534
1	499486.583	3929155.368	0.80	T6	499461.022	3929142.564	20.94
2	499486.198	3929154.671		27.52	T8	499467.577	
3	499472.904	3929130.572	15.32				

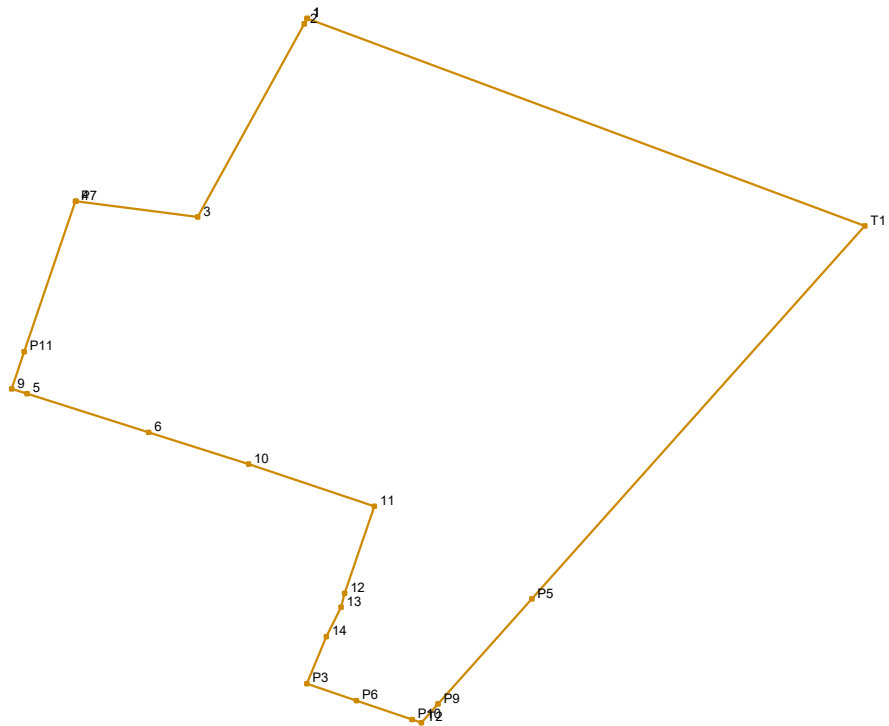

Νέα ιδιοκτησία εντός ΟΤ							
ιδ1:1461		ιδ2:02		Σημεία:21		Εμβαδό:4474.28 m <sup>2</sup>	
Σημείο	X	Y	μήκος	Σημείο	X	Y	μήκος
1	499486.583	3929155.368	74.28	11	499494.937	3929094.462	16.55
T1	499556.187	3929129.446	62.41	10	499479.240	3929099.706	13.09
P5	499514.622	3929082.892	17.58	6	499466.765	3929103.683	15.93
P9	499502.914	3929069.779	3.14	5	499451.586	3929108.522	1.99
T2	499500.821	3929067.435	1.21	9	499449.688	3929109.127	4.88
P10	499499.678	3929067.824	7.35	P11	499451.254	3929113.748	19.84
P6	499492.717	3929070.189	6.56	P7	499457.622	3929132.534	0.09
P3	499486.505	3929072.299	6.38	4	499457.714	3929132.531	15.32
14	499488.971	3929078.182	4.12	3	499472.904	3929130.572	27.52
13	499490.800	3929081.868	1.75	2	499486.198	3929154.671	0.80
12	499491.228	3929083.565	11.51	1	499486.583	3929155.368	

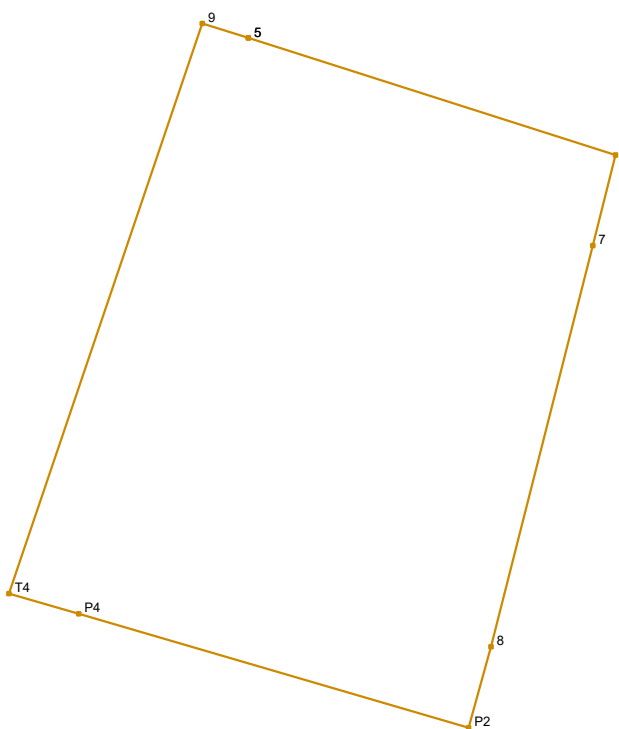

Νέα ιδιοκτησία εντός ΟΤ							
id1:1461		id2:03		Σημεία:8		Εμβαδό:465.29 m <sup>2</sup>	
Σημείο	X	Y	μήκος	Σημείο	X	Y	μήκος
5	499451.586	3929108.522	15.93	P4	499444.584	3929084.728	3.00
6	499466.765	3929103.683	3.85	T4	499441.703	3929085.569	24.87
7	499465.829	3929099.948	17.10	9	499449.688	3929109.127	1.99
8	499461.623	3929083.369	3.47	5	499451.586	3929108.522	
P2	499460.694	3929080.025	16.78				



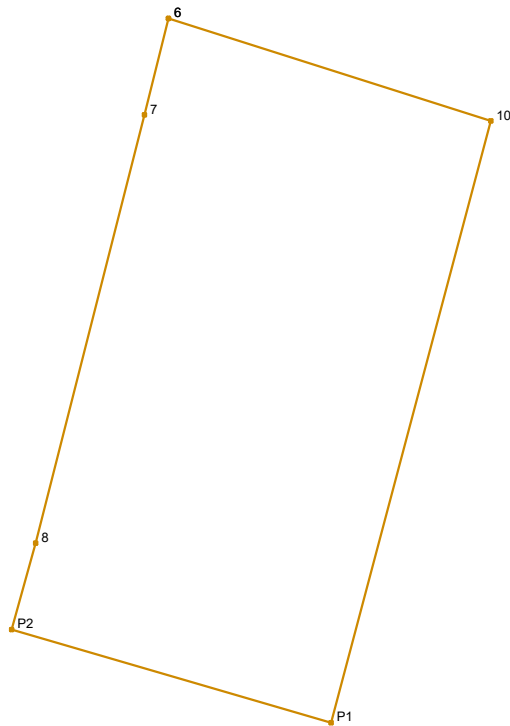

Νέα ιδιοκτησία εντός ΟΤ							
id1:1461		id2:04		Σημεία:6		Εμβαδό:313.86 m <sup>2</sup>	
Σημείο	X	Y	μήκος	Σημείο	X	Y	μήκος
6	499466.765	3929103.683	13.09	8	499461.623	3929083.369	17.10
10	499479.240	3929099.706		24.10	7	499465.829	3929099.948
P1	499473.059	3929076.415	12.88	6	499466.765	3929103.683	
P2	499460.694	3929080.025	3.47				

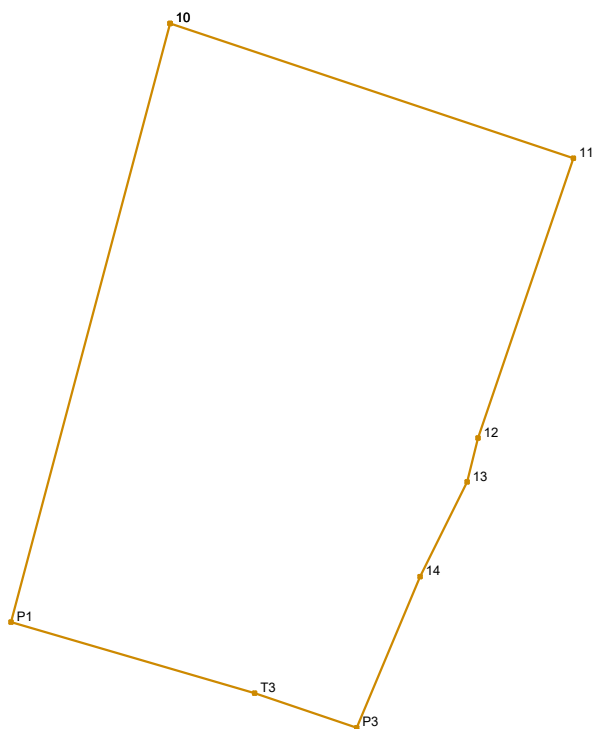

Νέα ιδιοκτησία εντός ΟΤ							
id1:1461		id2:05		Σημεία:8		Εμβαδό:370.07 m <sup>2</sup>	
Σημείο	X	Y	μήκος	Σημείο	X	Y	μήκος
10	499479.240	3929099.706	16.55	P3	499486.505	3929072.299	4.20
11	499494.937	3929094.462		T3	499482.530	3929073.650	9.87
12	499491.228	3929083.565	11.51	P1	499473.059	3929076.415	24.10
13	499490.800	3929081.868		1.75	10	499479.240	
14	499488.971	3929078.182	4.12				
			6.38				

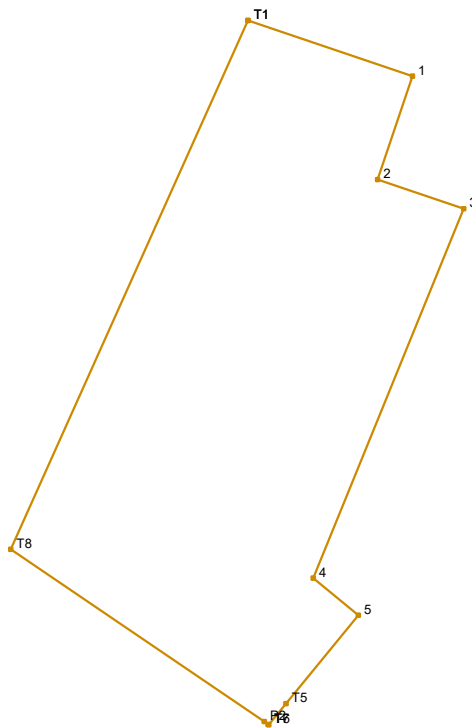

Νέα ιδιοκτησία εντός ΟΤ							
id1:1462		id2:01		Σημεία:11		Εμβαδό:3699.45 m <sup>2</sup>	
Σημείο	X	Y	μήκος	Σημείο	X	Y	μήκος
T1	499365.824	3929037.317		T5	499371.452	3928936.158	
			25.73				4.02
1	499390.186	3929029.046		T6	499368.910	3928933.049	
			16.16				0.11
2	499384.991	3929013.747		T7	499368.822	3928933.109	
			13.48				0.70
3	499397.755	3929009.413		P2	499368.247	3928933.500	
			59.05				45.37
4	499375.472	3928954.731		T8	499330.728	3928959.006	
			8.64				85.82
5	499382.163	3928949.261		T1	499365.824	3929037.317	
			16.92				

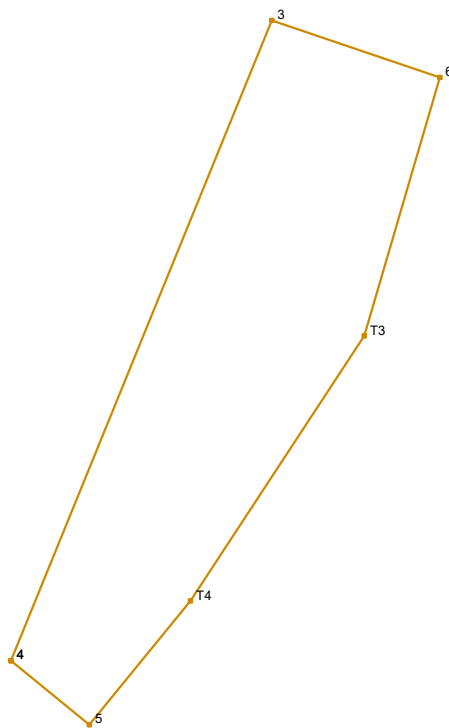

Νέα ιδιοκτησία εντός ΟΤ							
id1:1462		id2:02		Σημεία:6		Εμβαδό:884.87 m <sup>2</sup>	
Σημείο	X	Y	μήκος	Σημείο	X	Y	μήκος
4	499375.472	3928954.731	59.05	T4	499390.819	3928959.849	13.68
3	499397.755	3929009.413		15.15	5	499382.163	3928949.261
6	499412.100	3929004.542	22.99	4	499375.472	3928954.731	
T3	499405.654	3928982.472	27.05				

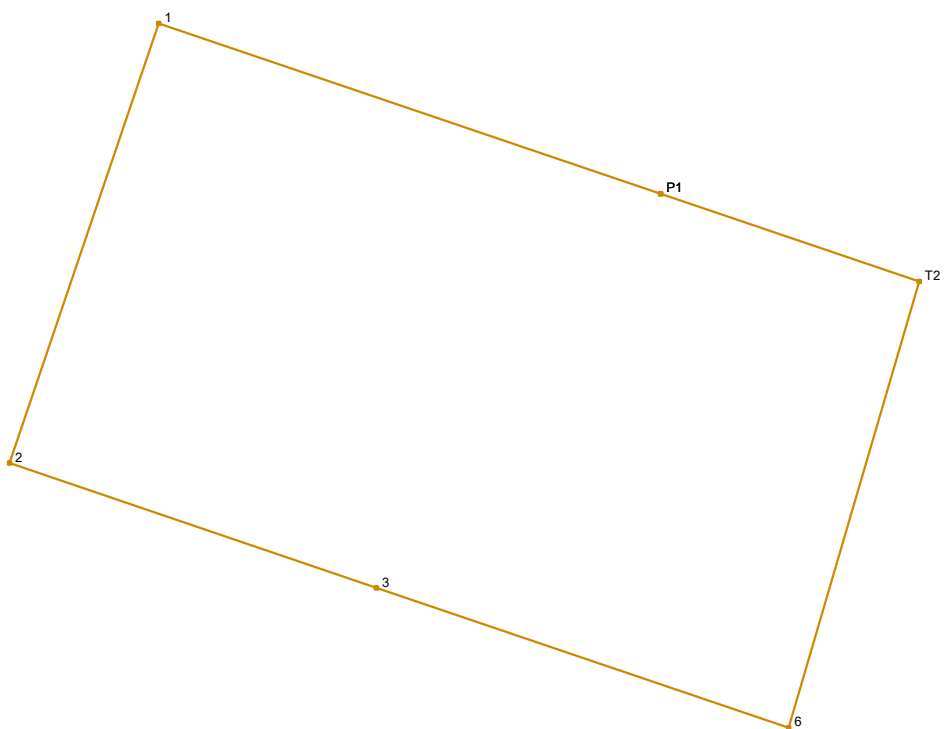

Νέα ιδιοκτησία εντός ΟΤ							
id1:1462		id2:03		Σημεία:6		Εμβαδό:456.91 m <sup>2</sup>	
Σημείο	X	Y	μήκος	Σημείο	X	Y	μήκος
P1	499407.638	3929023.120	9.50	2	499384.991	3929013.747	16.16
T2	499416.634	3929020.065		1	499390.186	3929029.046	
6	499412.100	3929004.542	16.17	P1	499407.638	3929023.120	
			15.15				
3	499397.755	3929009.413	13.48				

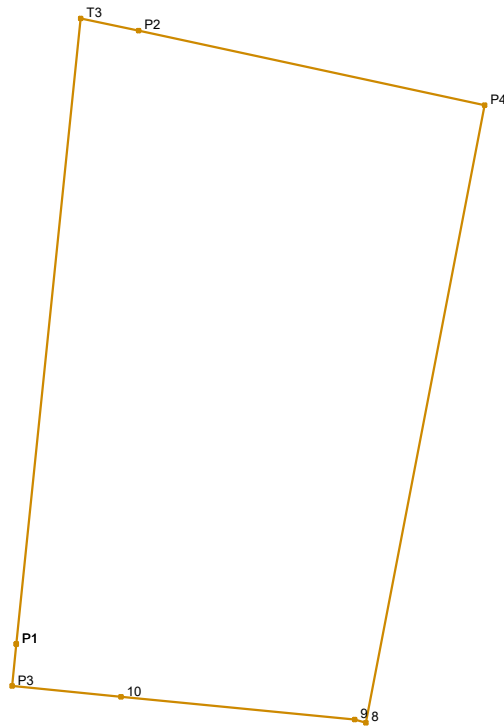

Νέα ιδιοκτησία εντός ΟΤ							
id1:1463		id2:01		Σημεία:8		Εμβαδό:521.50 m <sup>2</sup>	
Σημείο	X	Y	μήκος	Σημείο	X	Y	μήκος
P1	499369.381	3929064.907	28.79	9	499384.862	3929061.455	10.74
T3	499372.330	3929093.548		2.71	10	499374.171	3929062.487
P2	499374.978	3929092.979	16.20	P3	499369.184	3929062.992	1.93
P4	499390.817	3929089.574	28.79	P1	499369.381	3929064.907	
8	499385.377	3929061.307	0.54				

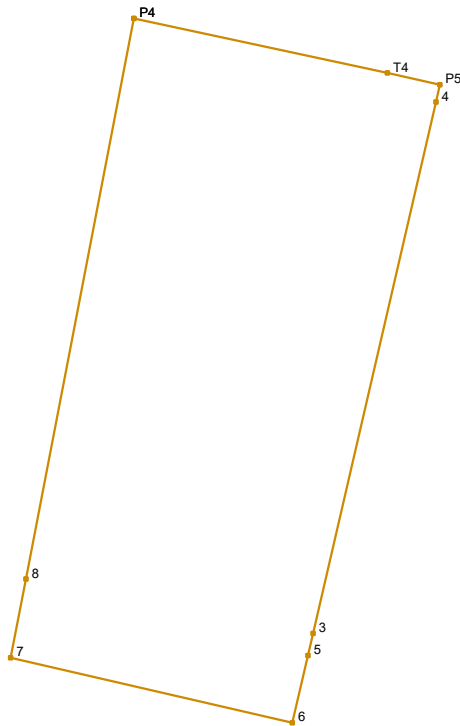

Νέα ιδιοκτησία εντός ΟΤ							
id1:1463		id2:02		Σημεία:9		Εμβαδό:500.00 m <sup>2</sup>	
Σημείο	X	Y	μήκος	Σημείο	X	Y	μήκος
P4	499390.817	3929089.574	13.08	5	499399.596	3929057.443	3.48
T4	499403.608	3929086.823		2.71	6	499398.812	
P5	499406.254	3929086.222	0.89		7	499384.613	3929057.339
4	499406.053	3929085.356		27.51	8	499385.377	3929061.307
3	499399.852	3929058.551	1.14		P4	499390.817	3929089.574

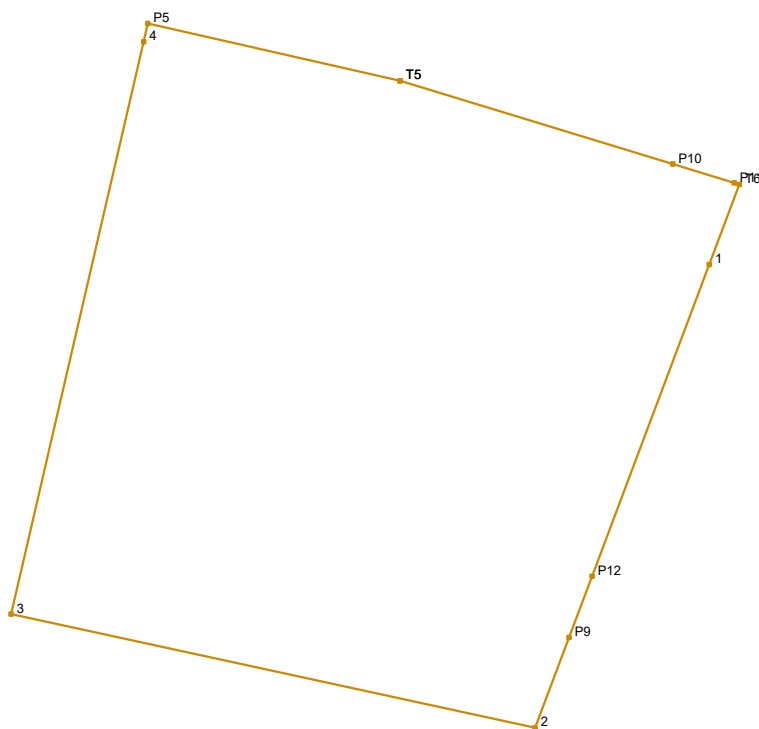

Νέα ιδιοκτησία εντός ΟΤ							
id1:1463		id2:03		Σημεία:11		Εμβαδό:752.32 m <sup>2</sup>	
Σημείο	X	Y	μήκος	Σημείο	X	Y	μήκος
T5	499418.064	3929083.535		P9	499425.978	3929057.464	
			13.35				4.52
P10	499430.829	3929079.633		2	499424.387	3929053.232	
			3.02				25.10
P11	499433.713	3929078.752		3	499399.852	3929058.551	
			0.25				27.51
T6	499433.955	3929078.678		4	499406.053	3929085.356	
			4.01				0.89
1	499432.544	3929074.926		P5	499406.254	3929086.222	
			15.60				12.11
P12	499427.055	3929060.328		T5	499418.064	3929083.535	
			3.06				



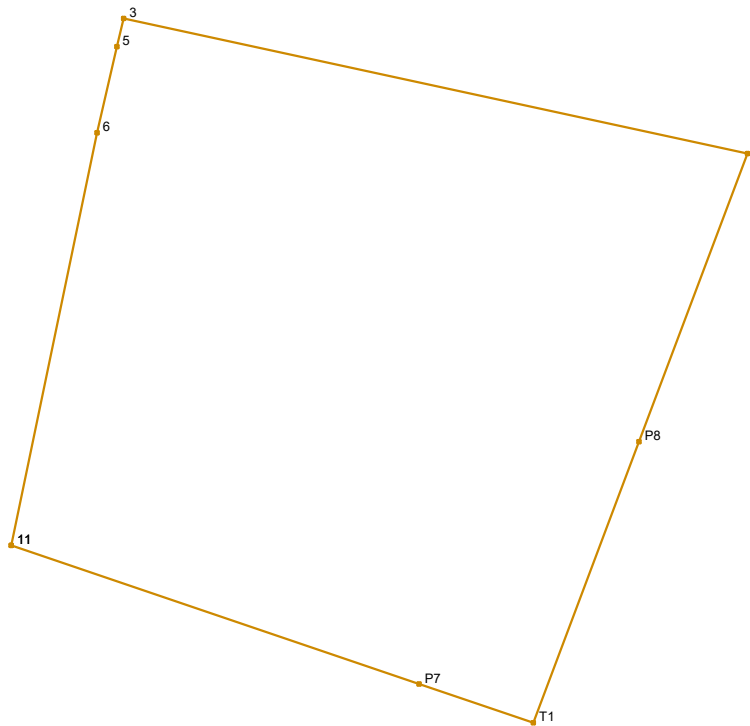

Νέα ιδιοκτησία εντός ΟΤ							
id1:1463		id2:04N		Σημεία:8		Εμβαδό:526.00 m <sup>2</sup>	
Σημείο	X	Y	μήκος	Σημείο	X	Y	μήκος
11	499395.438	3929037.823	16.58	P8	499420.129	3929041.907	11.81
6	499398.812	3929054.054	3.48	T1	499415.972	3929030.851	4.75
5	499399.596	3929057.443	1.14	P7	499411.478	3929032.377	16.94
3	499399.852	3929058.551	25.10	11	499395.438	3929037.823	
2	499424.387	3929053.232	12.10				

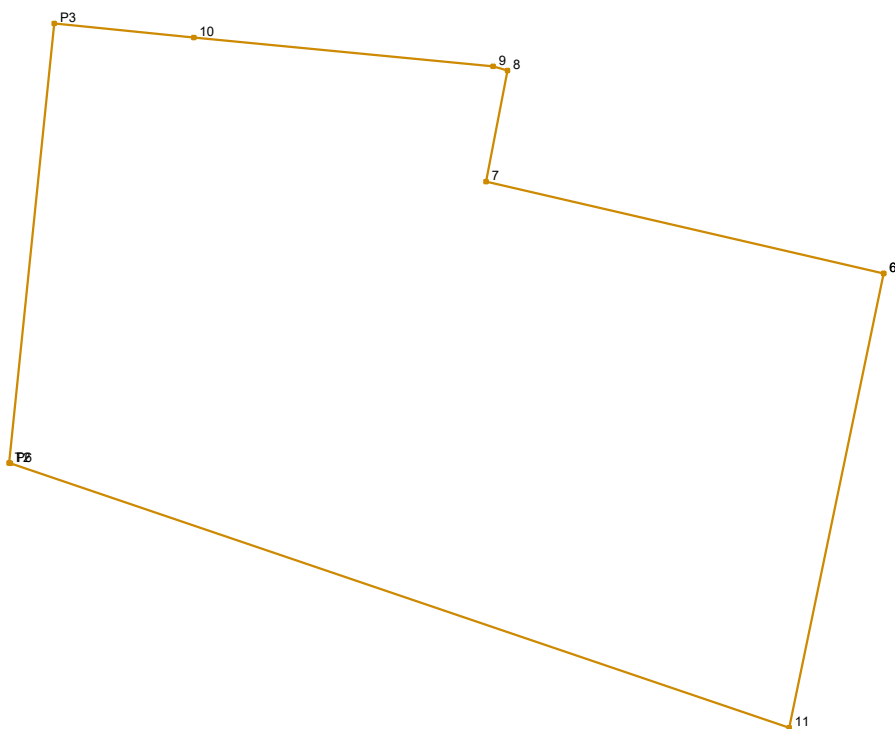

Νέα ιδιοκτησία εντός ΟΤ							
id1:1463		id2:05N		Σημεία:9		Εμβαδό:500.67 m <sup>2</sup>	
Σημείο	X	Y	μήκος	Σημείο	X	Y	μήκος
6	499398.812	3929054.054		10	499374.171	3929062.487	
			16.58				10.74
11	499395.438	3929037.823		9	499384.862	3929061.455	
			29.39				0.54
P6	499367.612	3929047.271		8	499385.377	3929061.307	
			0.05				4.04
T2	499367.567	3929047.286		7	499384.613	3929057.339	
			15.79				14.57
P3	499369.184	3929062.992		6	499398.812	3929054.054	
			5.01				