

ΕΛΛΗΝΙΚΗ ΔΗΜΟΚΡΑΤΙΑ  
ΠΕΡΙΦΕΡΕΙΑ ΚΡΗΤΗΣ  
ΔΗΜΟΣ ΧΑΝΙΩΝ

ΠΡΑΞΗ ΕΦΑΡΜΟΓΗΣ ΣΧΕΔΙΟΥ ΠΟΛΕΩΣ  
ΠΑΡΗΓΟΡΙΑ Δ.Ε. ΝΕΑΣ ΚΥΔΩΝΙΑΣ  
ΔΗΜΟΥ ΧΑΝΙΩΝ

Π Ρ Α Ξ Η Ε Φ Α Ρ Μ Ο Γ Η Σ

ΠΙΝΑΚΑΣ ΣΥΝΤΕΤΑΓΜΕΝΩΝ ΤΕΛΙΚΩΝ ΙΔΙΟΚΤΗΣΙΩΝ ΑΝΑ Ο.Τ.  
(ΣΕΛΙΔΕΣ 202-410, Ο.Τ. 1464 - Ο.Τ. 1510)

ΑΝΑΔΟΧΟΙ ΜΕΛΕΤΗΣ  
ΝΙΚΟΛΑΟΣ ΚΑΛΟΓΕΡΗΣ  
ΓΕΩΡΓΙΟΣ ΒΕΡΥΚΑΚΗΣ  
ΙΩΑΝΝΑ ΜΕΛΑΚΗ  
ΙΩΑΝΝΗΣ ΣΧΙΝΑΣ  
ΑΙΚΑΤΕΡΙΝΗ ΠΑΥΛΑΚΗ  
ΘΕΟΔΩΡΟΣ ΠΑΠΑΘΑΝΑΣΙΟΥ

ΓΙΑ ΤΟΝ ΑΝΑΔΟΧΟ ΤΗΣ ΜΕΛΕΤΗΣ:

ΓΕΩΡΓΙΟΣ ΒΕΡΥΚΑΚΗΣ

ΣΥΝΤΑΞΗ ΜΕΛΕΤΗΣ

**Ν. ΚΑΛΟΓΕΡΗΣ - Γ. ΒΕΡΥΚΑΚΗΣ**  
**ΑΓΡ. ΤΟΠΟΓΡΑΦΟΙ ΜΗΧΑΝΙΚΟΙ**

ΣΤΡ. ΤΖΑΝΑΚΑΚΗ 56 ΧΑΝΙΑ  
Τηλ. : 28210 44510

Δ ΔΕΚΕΜΒΡΙΟΣ 2022

Γ. ΒΕΡΥΚΑΚΗΣ  
ΤΟΠ. ΜΗΧ.

Γ ΣΕΠΤΕΜΒΡΙΟΣ 2022

Γ. ΒΕΡΥΚΑΚΗΣ  
ΤΟΠ. ΜΗΧ.

Β ΙΟΥΝΙΟΣ 2021

Γ. ΒΕΡΥΚΑΚΗΣ  
ΤΟΠ. ΜΗΧ.

Α ΑΠΡΙΛΙΟΣ 2017

Γ. ΒΕΡΥΚΑΚΗΣ  
ΤΟΠ. ΜΗΧ.

ΕΚΔΟΣΗ

ΗΜΕΡΟΜΗΝΙΑ

ΟΝΟΜΑΤΕΠΩΝΥΜΟ

ΥΠΟΓΡΑΦΗ

ΥΠΗΡΕΣΙΑ

ΕΝΕΡΓΕΙΑ

ΟΝΟΜΑΤΕΠΩΝΥΜΟ

ΗΜΕΡΟΜΗΝΙΑ

ΥΠΟΓΡΑΦΗ

ΔΗΜΟΣ ΧΑΝΙΩΝ

ΔΙΕΥΘΥΝΣΗ ΥΠΗΡΕΣΙΑΣ ΔΟΜΗΣΗΣ  
ΤΜΗΜΑ ΠΟΛΕΟΔΟΜΙΚΩΝ ΕΦΑΡΜΟΓΩΝ

ΕΛΕΓΧΘΗΚΕ

Η ΕΠΙΒΛΕΠΟΥΣΑ

ΙΟΥΛΙΑ ΜΑΝΩΛΙΚΑΚΗ  
ΤΟΠ. ΜΗΧ.

ΘΕΩΡΗΘΗΚΕ

Η ΑΝΑΠΛΗΡΩΤΡΙΑ  
ΠΡΟΪΣΤΑΜΕΝΗ

ΧΡΙΣΤΙΝΗ ΑΠΟΣΤΟΛΟΠΟΥΛΟΥ  
ΠΟΛ. ΜΗΧ.

ΕΓΚΡΙΘΗΚΕ

Ο ΑΝΑΠΛΗΡΩΤΗΣ  
ΔΙΕΥΘΥΝΤΗΣ

ΦΡΑΓΚΙΣΚΟΣ ΤΡΟΥΛΛΑΚΗΣ  
ΠΟΛ. ΜΗΧ.

ΑΠΟΦΑΣΗ ΕΓΚΡΙΣΗΣ

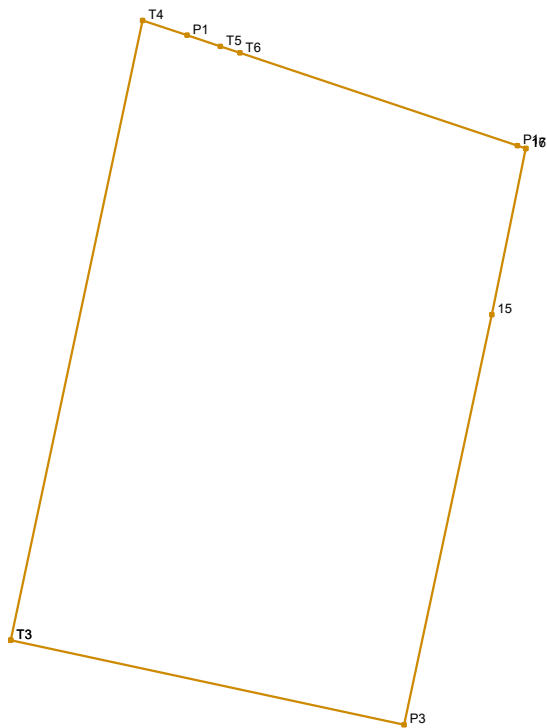

Νέα ιδιοκτησία εντός ΟΤ							
id1:1464		id2:01		Σημεία:10		Εμβαδό:593.22 m <sup>2</sup>	
Σημείο	X	Y	μήκος	Σημείο	X	Y	μήκος
T3	499373.382	3929103.551	31.11	17	499398.674	3929127.692	0.01
T4	499379.855	3929133.980		2.30	16	499398.673	3929127.686
P1	499382.037	3929133.253	1.73	15	499397.008	3929119.536	20.59
T5	499383.673	3929132.707	1.01	P3	499392.701	3929099.397	19.76
T6	499384.628	3929132.388	14.38	T3	499373.382	3929103.551	
P1	499398.262	3929127.830	0.43				

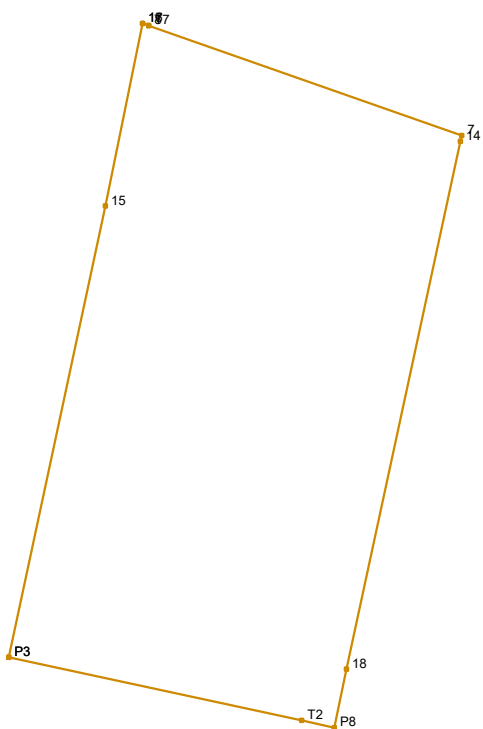

Νέα ιδιοκτησία εντός ΟΤ							
id1:1464		id2:02		Σημεία:11		Εμβαδό:416.09 m <sup>2</sup>	
Σημείο	X	Y	μήκος	Σημείο	X	Y	μήκος
P3	499392.701	3929099.397	20.59	7	499412.914	3929122.692	0.27
15	499397.008	3929119.536	8.32	14	499412.858	3929122.428	24.11
16	499398.673	3929127.686	0.01	18	499407.766	3929098.865	2.66
17	499398.674	3929127.692	0.29	P8	499407.226	3929096.256	1.49
T7	499398.945	3929127.602	0.01	T2	499405.769	3929096.587	13.37
8	499398.943	3929127.591	14.81	P3	499392.701	3929099.397	

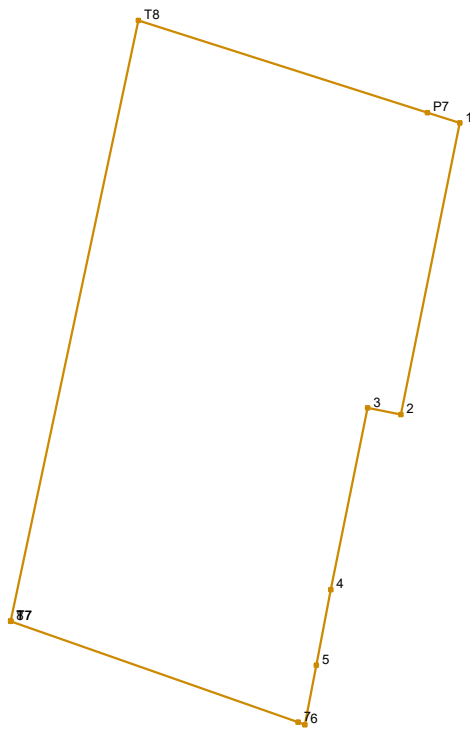

Νέα ιδιοκτησία εντός ΟΤ							
id1:1464		id2:03		Σημεία:11		Εμβαδό:469.34 m <sup>2</sup>	
Σημείο	X	Y	μήκος	Σημείο	X	Y	μήκος
T7	499398.945	3929127.602	29.83	4	499414.496	3929129.117	3.72
T8	499405.152	3929156.780		5	499413.792	3929125.461	2.95
P7	499419.184	3929152.298	14.73	6	499413.233	3929122.561	0.34
1	499420.768	3929151.792	1.66	7	499412.914	3929122.692	14.81
2	499417.903	3929137.623	14.46	8	499398.943	3929127.591	0.01
3	499416.283	3929137.951	1.65	T7	499398.945	3929127.602	9.01
			9.01				

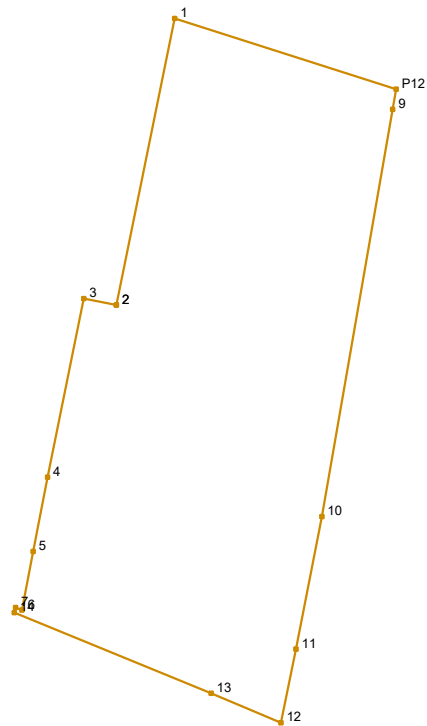

Νέα ιδιοκτησία εντός ΟΤ							
id1:1464		id2:04		Σημεία:14		Εμβαδό:395.54 m <sup>2</sup>	
Σημείο	X	Y	μήκος	Σημείο	X	Y	μήκος
2	499417.903	3929137.623	14.46	14	499412.858	3929122.428	0.27
1	499420.768	3929151.792	11.50	7	499412.914	3929122.692	0.34
P12	499431.723	3929148.292	1.02	6	499413.233	3929122.561	2.95
9	499431.544	3929147.292	20.42	5	499413.792	3929125.461	3.72
10	499428.050	3929127.175	6.67	4	499414.496	3929129.117	9.01
11	499426.774	3929120.629	3.71	3	499416.283	3929137.951	1.65
12	499426.020	3929116.993	3.73	2	499417.903	3929137.623	
13	499422.583	3929118.449	10.51				

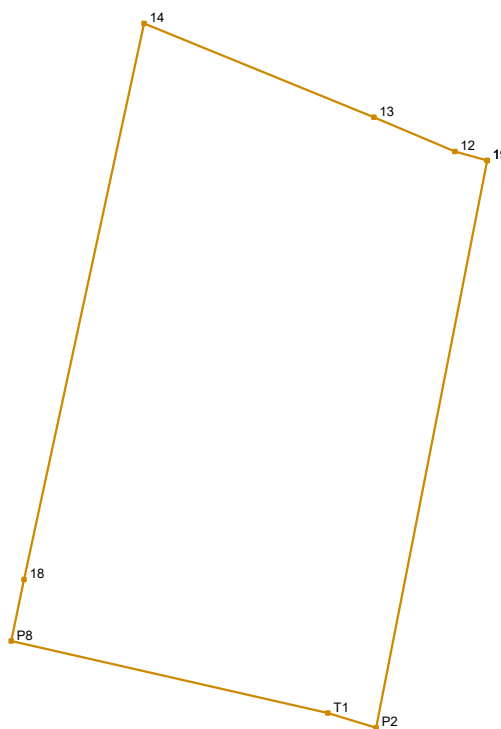

Νέα ιδιοκτησία εντός ΟΤ							
id1:1464		id2:05		Σημεία:8		Εμβαδό:399.16 m <sup>2</sup>	
Σημείο	X	Y	μήκος	Σημείο	X	Y	μήκος
19	499427.394	3929116.621		14	499412.858	3929122.428	10.51
P2	499422.680	3929092.581	24.50	13	499422.583	3929118.449	3.73
T1	499420.638	3929093.205	2.14	12	499426.020	3929116.993	1.42
P8	499407.226	3929096.256	13.75	19	499427.394	3929116.621	
18	499407.766	3929098.865	2.66				
			24.11				

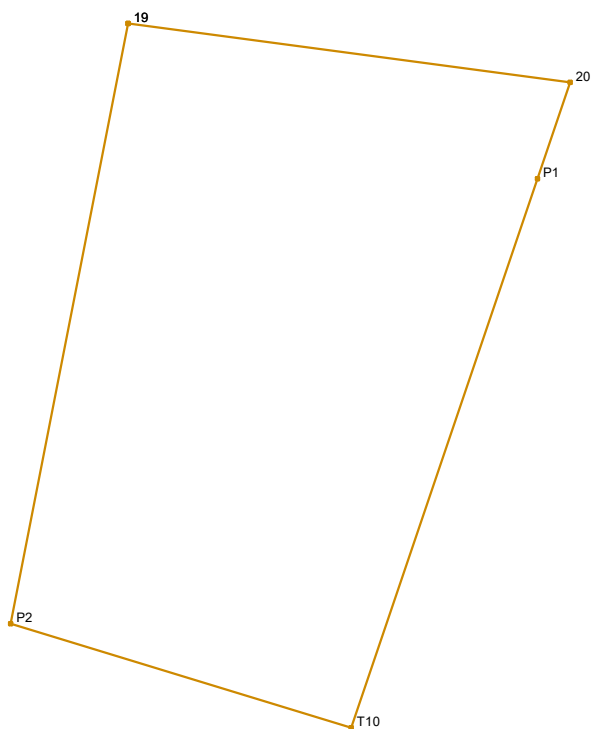

Νέα ιδιοκτησία εντός ΟΤ							
id1:1464		id2:06		Σημεία:5		Εμβαδό:413.04 m <sup>2</sup>	
Σημείο	X	Y	μήκος	Σημείο	X	Y	μήκος
19	499427.394	3929116.621	17.86	T10	499436.330	3929088.409	14.27
20	499445.093	3929114.261		4.08	P2	499422.680	3929092.581
P1	499443.783	3929110.396	23.22	19	499427.394	3929116.621	

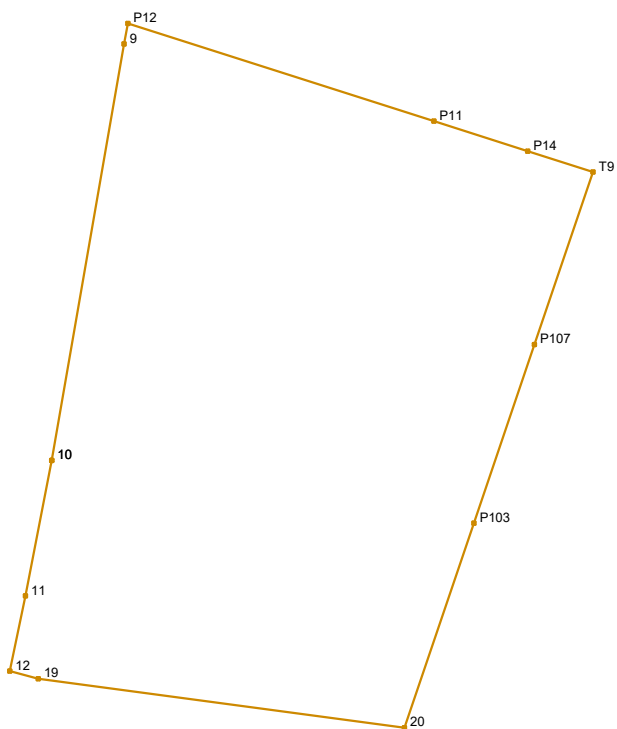

Νέα ιδιοκτησία εντός ΟΤ							
id1:1464		id2:07		Σημεία:12		Εμβαδό:639.48 m <sup>2</sup>	
Σημείο	X	Y	μήκος	Σημείο	X	Y	μήκος
10	499428.050	3929127.175	20.42	P103	499448.440	3929124.137	10.43
9	499431.544	3929147.292	1.02	20	499445.093	3929114.261	17.86
P12	499431.723	3929148.292	15.52	19	499427.394	3929116.621	1.42
P11	499446.508	3929143.569	4.77	12	499426.020	3929116.993	3.71
P14	499451.050	3929142.118	3.30	11	499426.774	3929120.629	6.67
T9	499454.195	3929141.113	8.81	10	499428.050	3929127.175	
P107	499451.366	3929132.769	9.11				



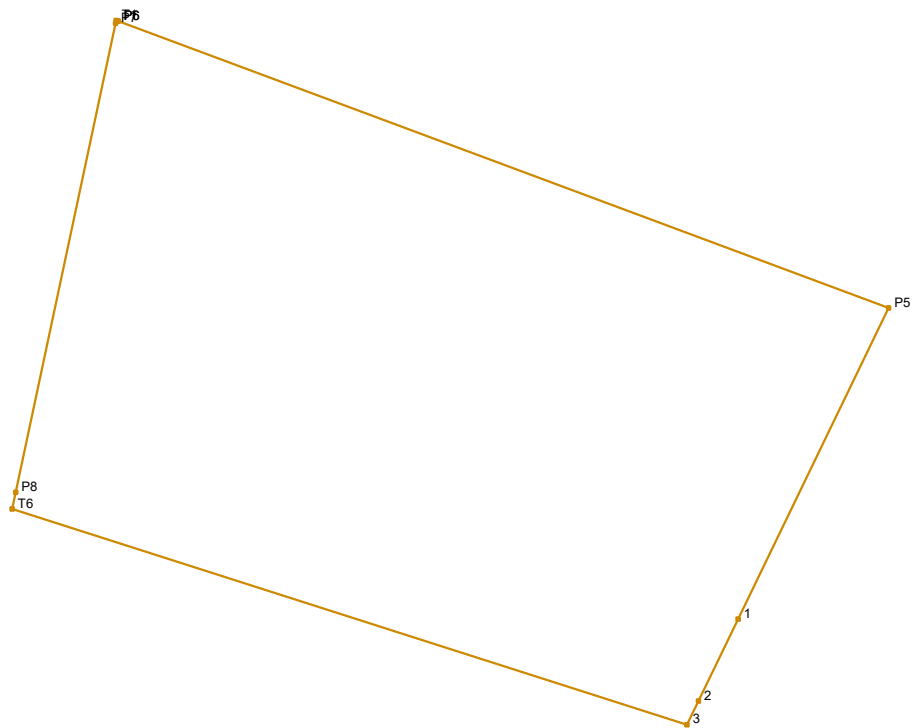

Νέα ιδιοκτησία εντός ΟΤ							
id1:1465		id2:01		Σημεία:9		Εμβαδό:666.15 m <sup>2</sup>	
Σημείο	X	Y	μήκος	Σημείο	X	Y	μήκος
P6	499391.986	3929190.598	35.07	T6	499387.469	3929169.778	0.74
P5	499424.852	3929178.358		14.73	P8	499387.622	3929170.499
1	499418.442	3929165.093	3.89	P7	499391.876	3929190.497	0.13
2	499416.749	3929161.594	1.13	T1	499391.904	3929190.629	0.09
3	499416.259	3929160.581	30.22	P6	499391.986	3929190.598	

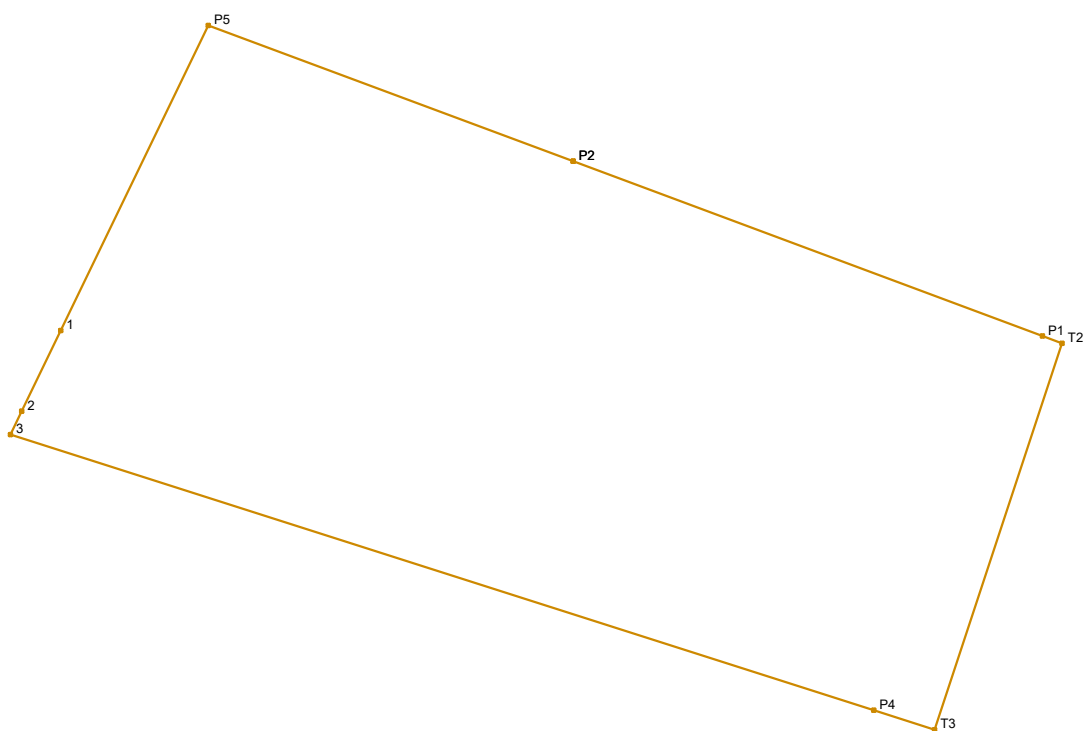

Νέα ιδιοκτησία εντός ΟΤ							
id1:1465		id2:02N		Σημεία:9		Εμβαδό:761.71 m <sup>2</sup>	
Σημείο	X	Y	μήκος	Σημείο	X	Y	μήκος
P2	499440.706	3929172.454	21.76	3	499416.259	3929160.581	1.13
P1	499461.099	3929164.859		0.91	2	499416.749	3929161.594
T2	499461.950	3929164.542	17.68	1	499418.442	3929165.093	14.73
T3	499456.415	3929147.752		2.77	P5	499424.852	3929178.358
P4	499453.775	3929148.596	39.38	P2	499440.706	3929172.454	

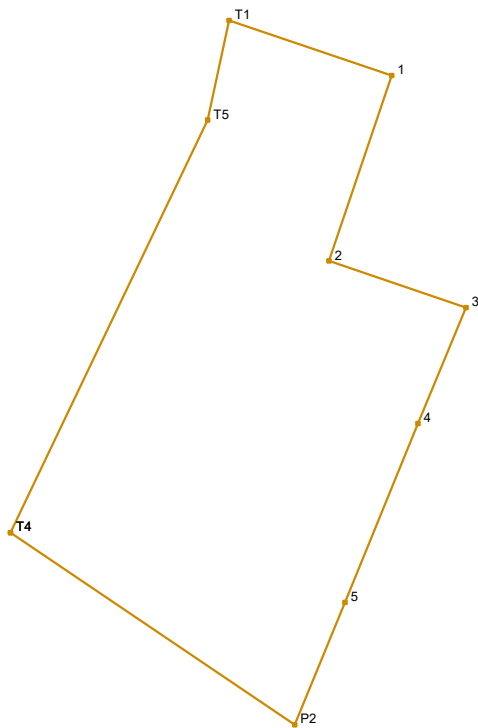

Νέα ιδιοκτησία εντός ΟΤ							
id1:1466		id2:01		Σημεία:9		Εμβαδό:2082.90 m <sup>2</sup>	
Σημείο	X	Y	μήκος	Σημείο	X	Y	μήκος
T4	499258.591	3929007.826	51.38	3	499309.780	3929033.113	14.11
T5	499280.750	3929054.183		11.46	4	499304.365	3929020.088
T1	499283.162	3929065.384	19.30	5	499296.161	3928999.984	14.87
1	499301.441	3929059.178	22.00	P2	499290.512	3928986.226	38.54
2	499294.368	3929038.346	16.28	T4	499258.591	3929007.826	

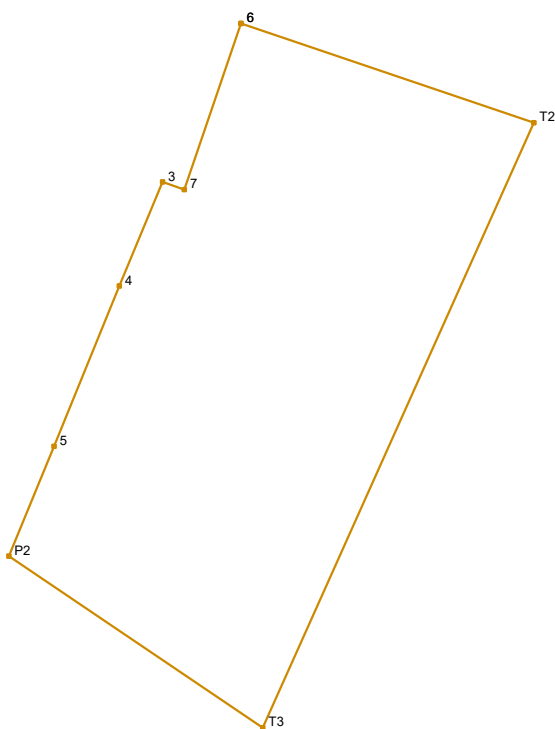

Νέα ιδιοκτησία εντός ΟΤ							
id1:1466		id2:02		Σημεία:8		Εμβαδό:2987.19 m <sup>2</sup>	
Σημείο	X	Y	μήκος	Σημείο	X	Y	μήκος
6	499319.596	3929053.013	38.78	4	499304.365	3929020.088	14.11
T2	499356.313	3929040.546	83.11	3	499309.780	3929033.113	2.90
T3	499322.322	3928964.702	38.41	7	499312.523	3929032.181	22.00
P2	499290.512	3928986.226	14.87	6	499319.596	3929053.013	
5	499296.161	3928999.984	21.71				

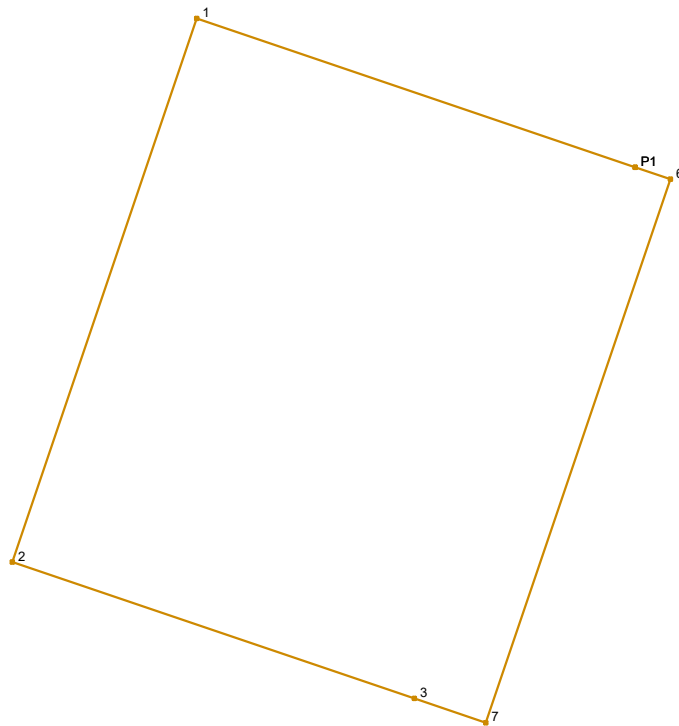

Νέα ιδιοκτησία εντός ΟΤ							
id1:1466		id2:03N		Σημεία:6		Εμβαδό:421.82 m <sup>2</sup>	
Σημείο	X	Y	μήκος	Σημείο	X	Y	μήκος
P1	499318.244	3929053.472	1.43	2	499294.368	3929038.346	22.00
6	499319.596	3929053.013	22.00	1	499301.441	3929059.178	17.75
7	499312.523	3929032.181	2.90	P1	499318.244	3929053.472	
3	499309.780	3929033.113	16.28				

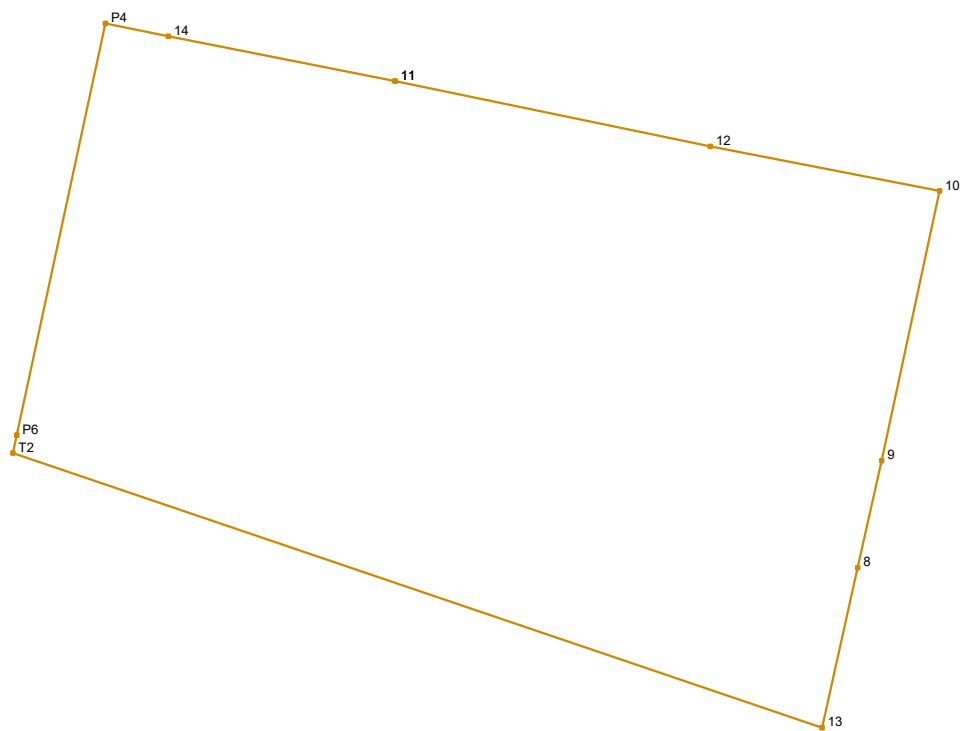

Νέα ιδιοκτησία εντός ΟΤ							
id1:1467		id2:01		Σημεία:10		Εμβαδό:822.79 m <sup>2</sup>	
Σημείο	X	Y	μήκος	Σημείο	X	Y	μήκος
11	499302.187	3929091.683	14.25	T2	499285.282	3929075.225	0.81
12	499316.142	3929088.793	10.34	P6	499285.453	3929076.018	18.64
10	499326.288	3929086.824	12.22	P4	499289.377	3929094.237	2.84
9	499323.716	3929074.878	4.85	14	499292.159	3929093.658	10.22
8	499322.665	3929070.146	7.25	11	499302.187	3929091.683	
13	499321.092	3929063.066	37.82				

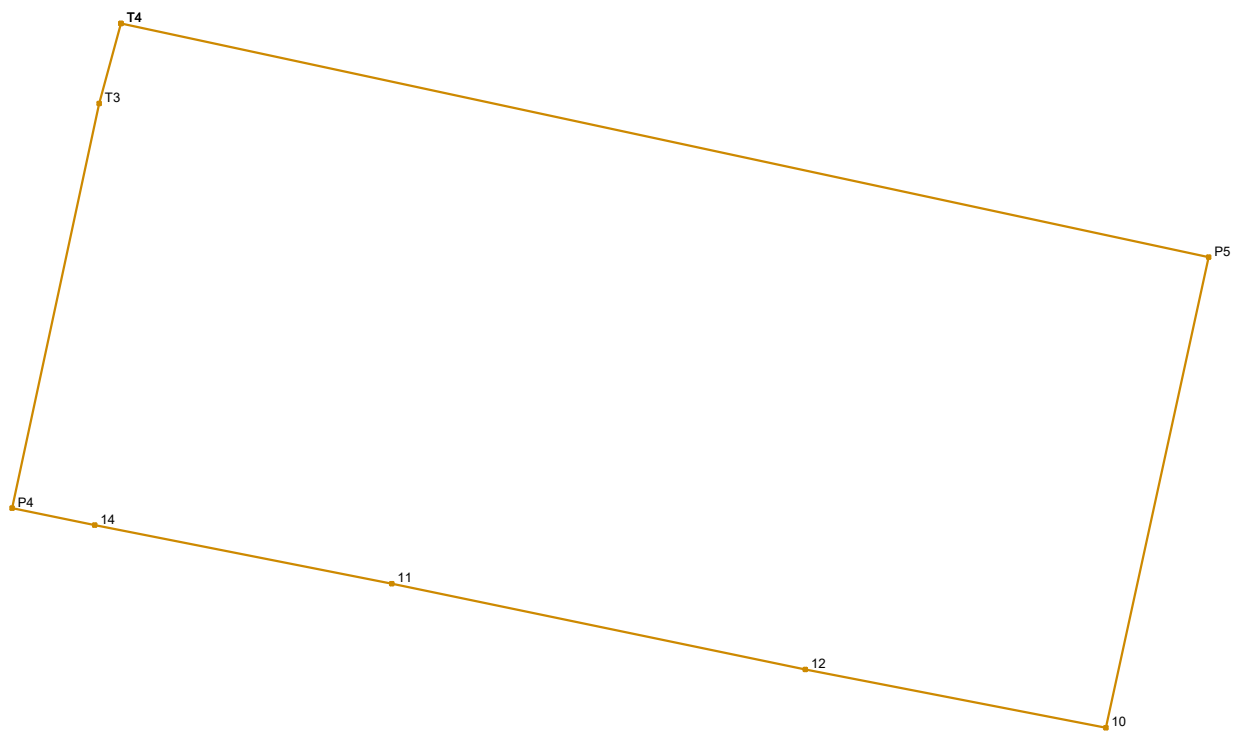

Νέα ιδιοκτησία εντός ΟΤ							
id1:1467		id2:02		Σημεία:8		Εμβαδό:622.33 m <sup>2</sup>	
Σημείο	X	Y	μήκος	Σημείο	X	Y	μήκος
T4	499293.049	3929110.594	37.54	14	499292.159	3929093.658	2.84
P5	499329.752	3929102.703		P4	499289.377	3929094.237	13.97
10	499326.288	3929086.824	10.34	T3	499292.318	3929107.892	2.80
12	499316.142	3929088.793	14.25	T4	499293.049	3929110.594	
11	499302.187	3929091.683	10.22				

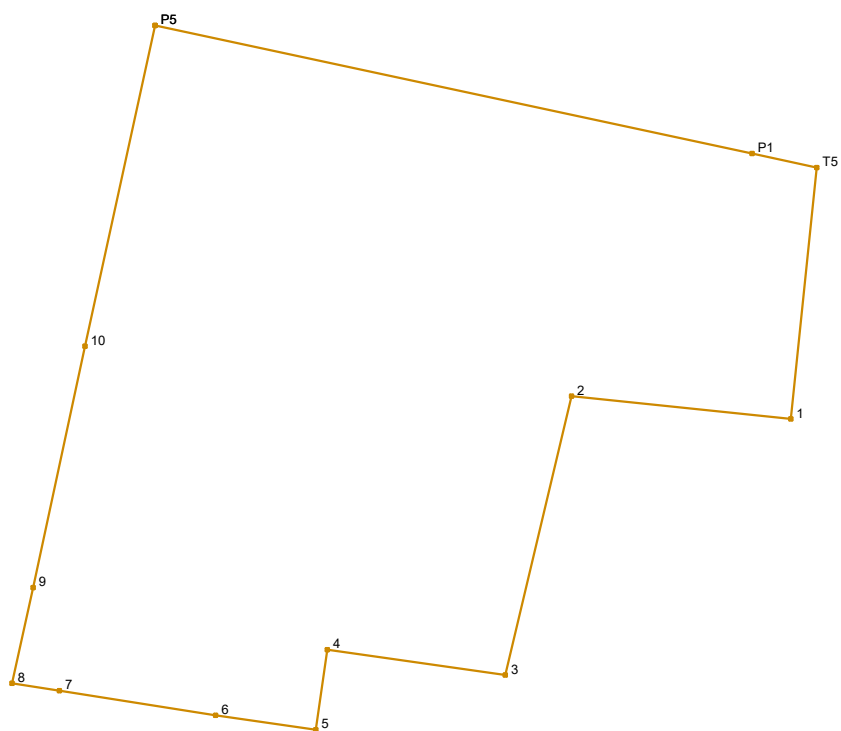

Νέα ιδιοκτησία εντός ΟΤ							
id1:1467		id2:03		Σημεία:13		Εμβαδό:878.20 m <sup>2</sup>	
Σημείο	X	Y	μήκος	Σημείο	X	Y	μήκος
P5	499329.752	3929102.703	30.22	5	499337.703	3929067.841	5.00
P1	499359.299	3929096.350		3.27	6	499332.753	3929068.550
T5	499362.495	3929095.663	12.50	7	499325.020	3929069.773	2.38
1	499361.215	3929083.229	10.91	8	499322.665	3929070.146	4.85
2	499350.362	3929084.346	14.18	9	499323.716	3929074.878	12.22
3	499347.089	3929070.546	8.91	10	499326.288	3929086.824	16.25
4	499338.270	3929071.808	4.01	P5	499329.752	3929102.703	



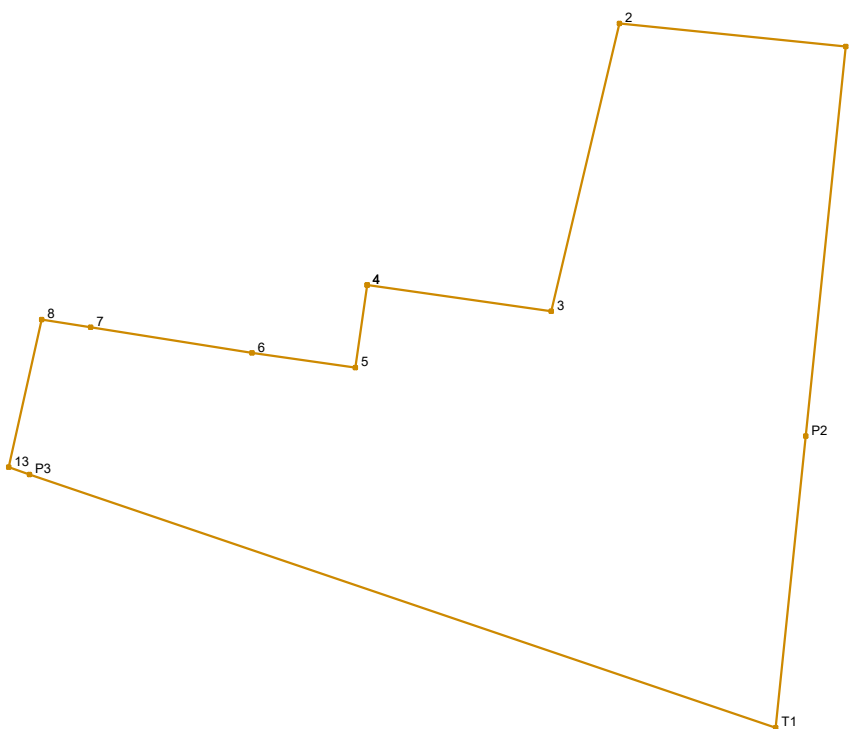

Νέα ιδιοκτησία εντός ΟΤ							
id1:1467		id2:04N		Σημεία:12		Εμβαδό:658.16 m <sup>2</sup>	
Σημείο	X	Y	μήκος	Σημείο	X	Y	μήκος
4	499338.270	3929071.808	8.91	13	499321.092	3929063.066	7.25
3	499347.089	3929070.546	14.18	8	499322.665	3929070.146	2.38
2	499350.362	3929084.346	10.91	7	499325.020	3929069.773	7.83
1	499361.215	3929083.229	18.76	6	499332.753	3929068.550	5.00
P2	499359.293	3929064.564	14.05	5	499337.703	3929067.841	4.01
T1	499357.853	3929050.584	37.77	4	499338.270	3929071.808	
P3	499322.091	3929062.727	1.05				

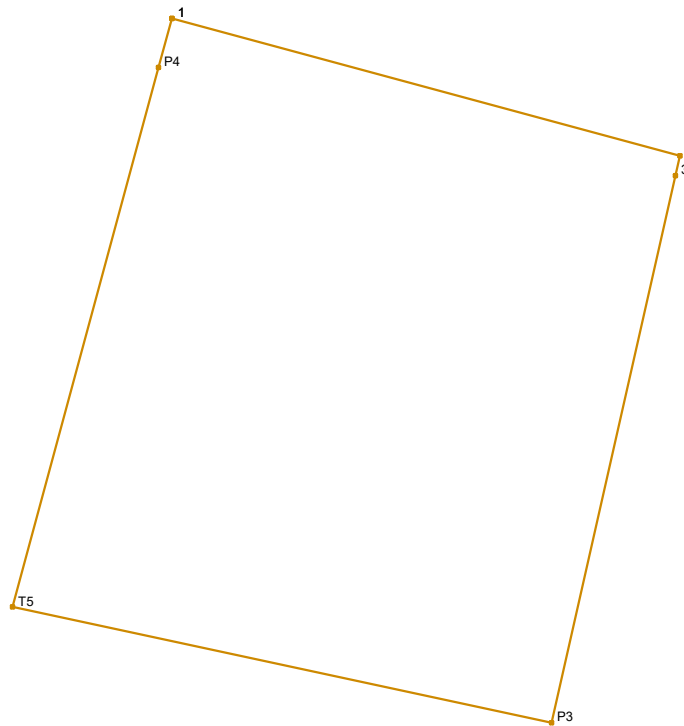

Νέα ιδιοκτησία εντός ΟΤ							
id1:1468		id2:01		Σημεία:6		Εμβαδό:354.27 m <sup>2</sup>	
Σημείο	X	Y	μήκος	Σημείο	X	Y	μήκος
1	499300.957	3929139.820	17.50	T5	499295.664	3929120.261	18.57
2	499317.847	3929135.250		P4	499300.516	3929138.190	1.69
3	499317.697	3929134.586	0.68	1	499300.957	3929139.820	
P3	499313.580	3929116.409	18.64				
			18.33				

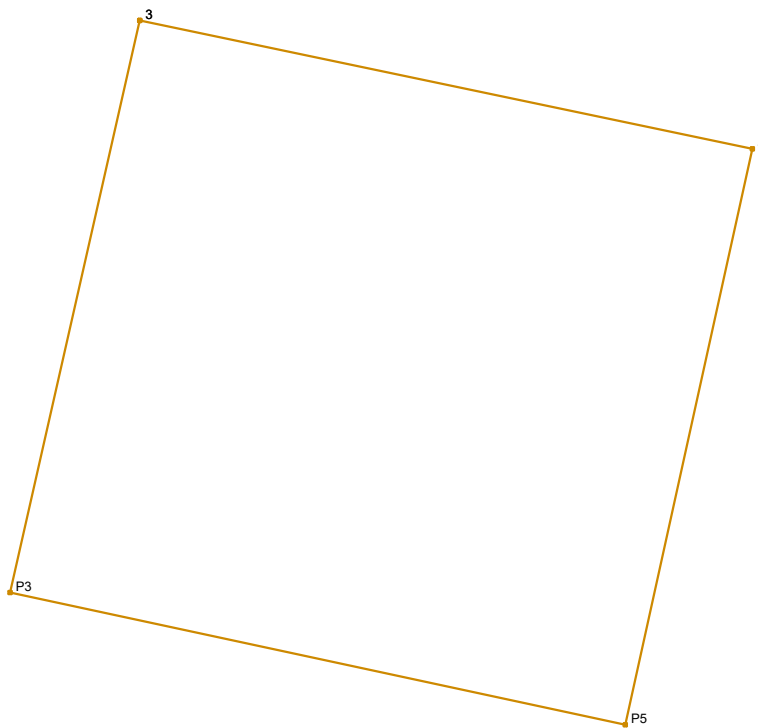

Νέα ιδιοκτησία εντός ΟΤ							
id1:1468		id2:02		Σημεία:4		Εμβαδό:372.63 m <sup>2</sup>	
Σημείο	X	Y	μήκος	Σημείο	X	Y	μήκος
3	499317.697	3929134.586	19.89	P3	499313.580	3929116.409	18.64
4	499337.164	3929130.502	18.74	3	499317.697	3929134.586	
P5	499333.126	3929112.206	19.99				

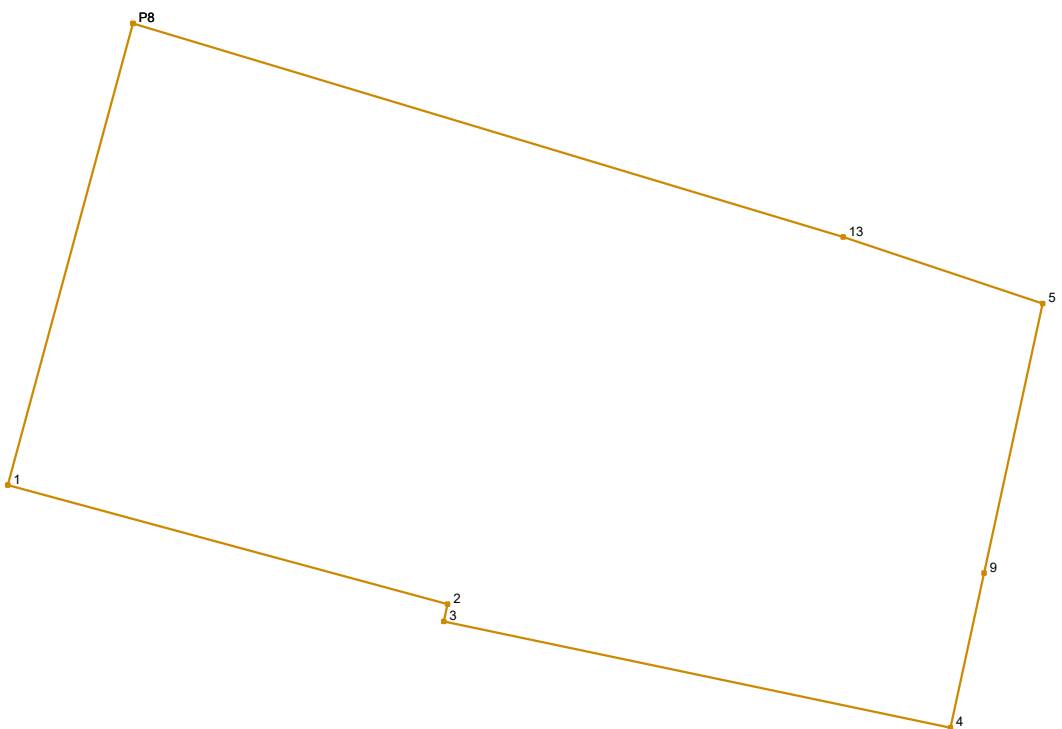

Νέα ιδιοκτησία εντός ΟΤ							
id1:1468		id2:03		Σημεία:8		Εμβαδό:661.61 m <sup>2</sup>	
Σημείο	X	Y	μήκος	Σημείο	X	Y	μήκος
P8	499305.757	3929157.558	28.49	3	499317.697	3929134.586	0.68
13	499333.039	3929149.357	8.08	2	499317.847	3929135.250	17.50
5	499340.705	3929146.794	10.59	1	499300.957	3929139.820	18.38
9	499338.458	3929136.442	6.08	P8	499305.757	3929157.558	
4	499337.164	3929130.502	19.89				

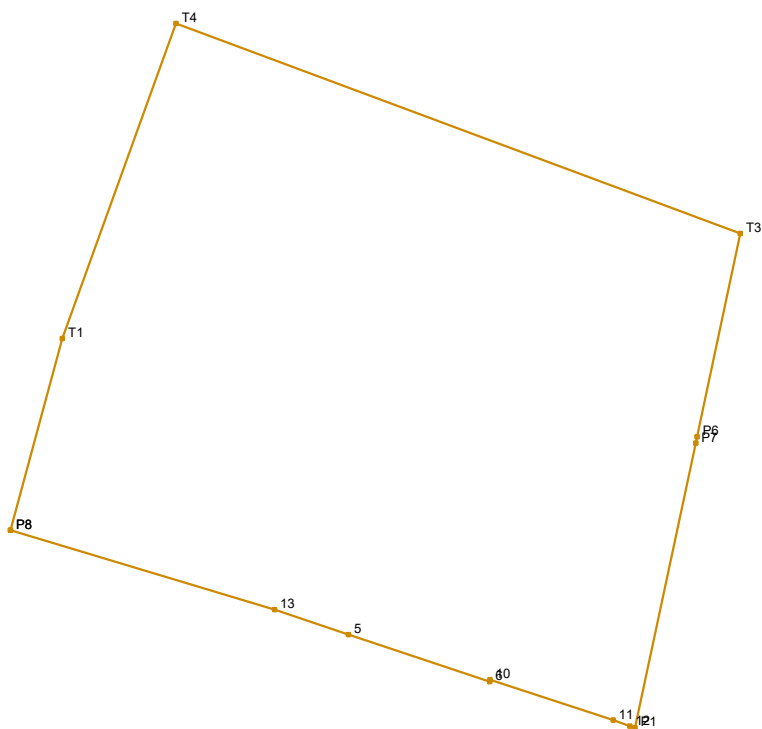

Νέα ιδιοκτησία εντός ΟΤ							
id1:1468		id2:04		Σημεία:13		Εμβαδό:3487.97 m <sup>2</sup>	
Σημείο	X	Y	μήκος	Σημείο	X	Y	μήκος
P8	499305.757	3929157.558		12	499369.766	3929137.338	
			20.52				1.82
T1	499311.116	3929177.364		11	499368.051	3929137.951	
			34.63				13.41
T4	499322.874	3929209.935		10	499355.304	3929142.122	
			62.21				0.20
T3	499381.169	3929188.224		6	499355.262	3929141.926	
			21.47				15.35
P6	499376.702	3929167.227		5	499340.705	3929146.794	
			0.68				8.08
P7	499376.561	3929166.564		13	499333.039	3929149.357	
			30.06				28.49
P1	499370.307	3929137.158		P8	499305.757	3929157.558	
			0.57				

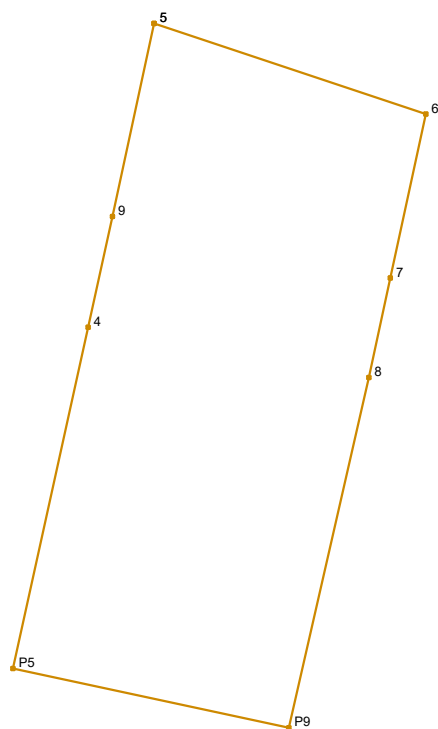

Νέα ιδιοκτησία εντός ΟΤ							
id1:1468		id2:05		Σημεία:8		Εμβαδό:526.34 m <sup>2</sup>	
Σημείο	X	Y	μήκος	Σημείο	X	Y	μήκος
5	499340.705	3929146.794	15.35	P5	499333.126	3929112.206	18.74
6	499355.262	3929141.926	9.00	4	499337.164	3929130.502	6.08
7	499353.360	3929133.132	5.45	9	499338.458	3929136.442	10.59
8	499352.208	3929127.807	19.26	5	499340.705	3929146.794	
P9	499347.924	3929109.025	15.14				

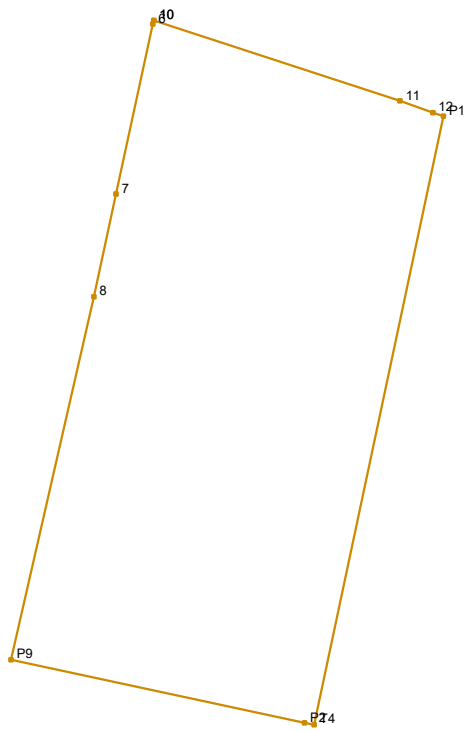

Νέα ιδιοκτησία εντός ΟΤ							
id1:1468		id2:06		Σημεία:10		Εμβαδό:523.67 m <sup>2</sup>	
Σημείο	X	Y	μήκος	Σημείο	X	Y	μήκος
10	499355.304	3929142.122		P9	499347.924	3929109.025	19.26
			13.41				
11	499368.051	3929137.951		8	499352.208	3929127.807	5.45
			1.82				
12	499369.766	3929137.338		7	499353.360	3929133.132	9.00
			0.57				
P1	499370.307	3929137.158		6	499355.262	3929141.926	0.20
			32.21				
T4	499363.606	3929105.653		10	499355.304	3929142.122	
			0.51				
P2	499363.109	3929105.760					
			15.53				

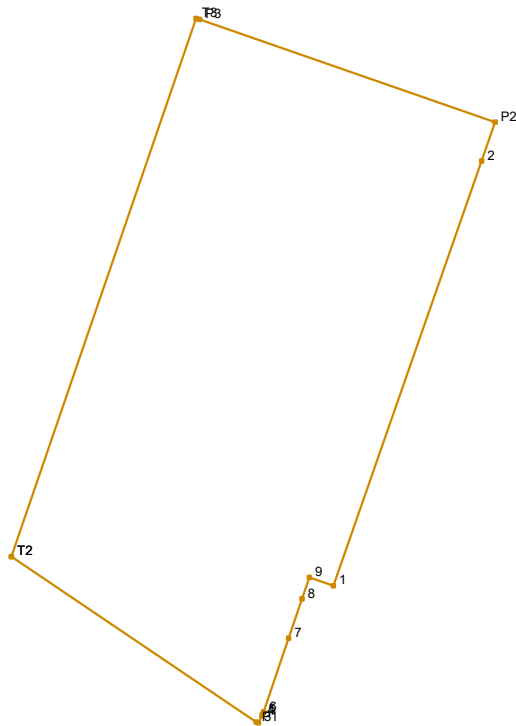

Νέα ιδιοκτησία εντός ΟΤ							
id1:1469		id2:01		Σημεία:14		Εμβαδό:4379.51 m <sup>2</sup>	
Σημείο	X	Y	μήκος	Σημείο	X	Y	μήκος
T2	499182.571	3929059.267	86.76	7	499224.826	3929046.805	11.85
T3	499210.729	3929141.333	0.58	6	499220.997	3929035.587	0.36
P3	499211.273	3929141.144	47.67	5	499220.859	3929035.257	0.28
P2	499256.304	3929125.491	6.25	4	499220.752	3929035.001	1.17
2	499254.265	3929119.582	68.59	3	499220.253	3929033.942	0.39
1	499231.631	3929054.836	3.85	P1	499219.875	3929034.025	45.04
9	499228.000	3929056.105	3.46	T2	499182.571	3929059.267	
8	499226.882	3929052.830	6.37				



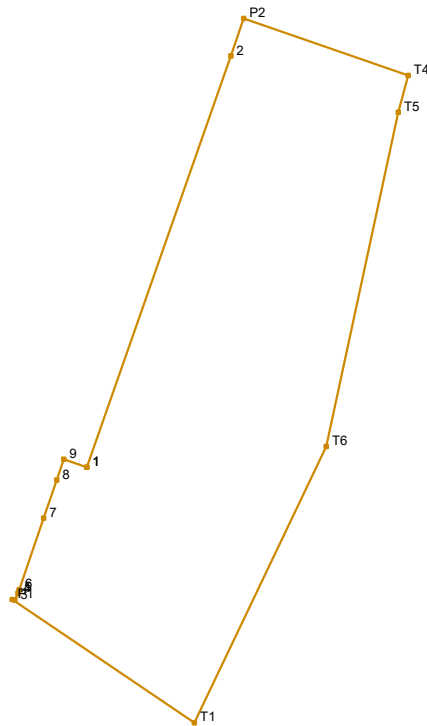

Νέα ιδιοκτησία εντός ΟΤ							
id1:1469		id2:02		Σημεία:15		Εμβαδό:3332.83 m <sup>2</sup>	
Σημείο	X	Y	μήκος	Σημείο	X	Y	μήκος
1	499231.631	3929054.836	68.59	3	499220.253	3929033.942	1.17
2	499254.265	3929119.582	6.25	4	499220.752	3929035.001	0.28
P2	499256.304	3929125.491	27.43	5	499220.859	3929035.257	0.36
T4	499282.211	3929116.486	5.97	6	499220.997	3929035.587	11.85
T5	499280.652	3929110.724	53.84	7	499224.826	3929046.805	6.37
T6	499269.316	3929058.087	48.17	8	499226.882	3929052.830	3.46
T1	499248.542	3929014.626	34.61	9	499228.000	3929056.105	3.85
P1	499219.875	3929034.025	0.39	1	499231.631	3929054.836	

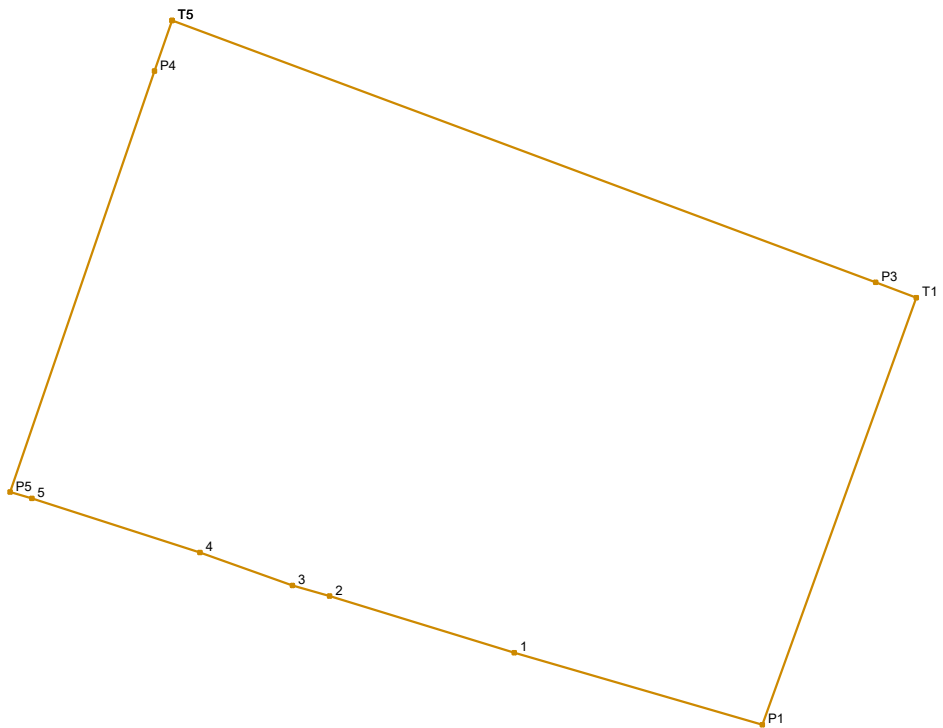

Νέα ιδιοκτησία εντός ΟΤ							
id1:1470		id2:01		Σημεία:11		Εμβαδό:3105.66 m <sup>2</sup>	
Σημείο	X	Y	μήκος	Σημείο	X	Y	μήκος
T5	499246.256	3929244.872	67.99	3	499257.172	3929193.699	8.89
P3	499309.973	3929221.142		4	499248.795	3929196.674	16.00
T1	499313.665	3929219.767	3.94	5	499233.560	3929201.577	2.04
P1	499299.703	3929181.090	41.12	P5	499231.605	3929202.173	40.28
1	499277.255	3929187.603	23.37	P4	499244.678	3929240.274	4.86
2	499260.529	3929192.752	17.50	T5	499246.256	3929244.872	
			3.49				

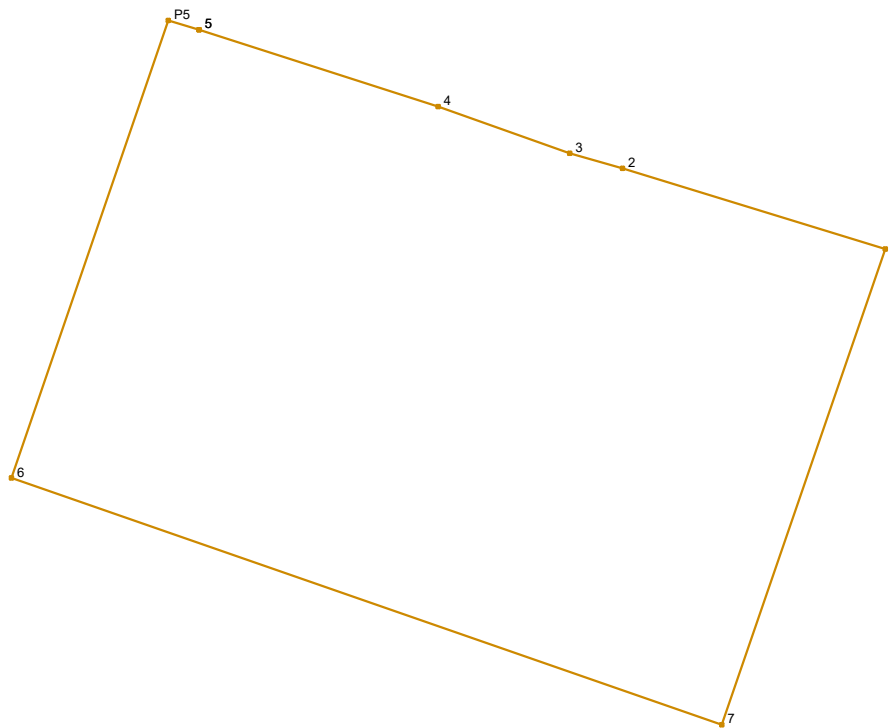

Νέα ιδιοκτησία εντός ΟΤ							
id1:1470		id2:02N		Σημεία:8		Εμβαδό:1500.39 m <sup>2</sup>	
Σημείο	X	Y	μήκος	Σημείο	X	Y	μήκος
5	499233.560	3929201.577	16.00	7	499266.844	3929157.328	47.89
4	499248.795	3929196.674	8.89	6	499221.613	3929173.051	30.79
3	499257.172	3929193.699	3.49	P5	499231.605	3929202.173	2.04
2	499260.529	3929192.752	17.50	5	499233.560	3929201.577	
1	499277.255	3929187.603	32.01				

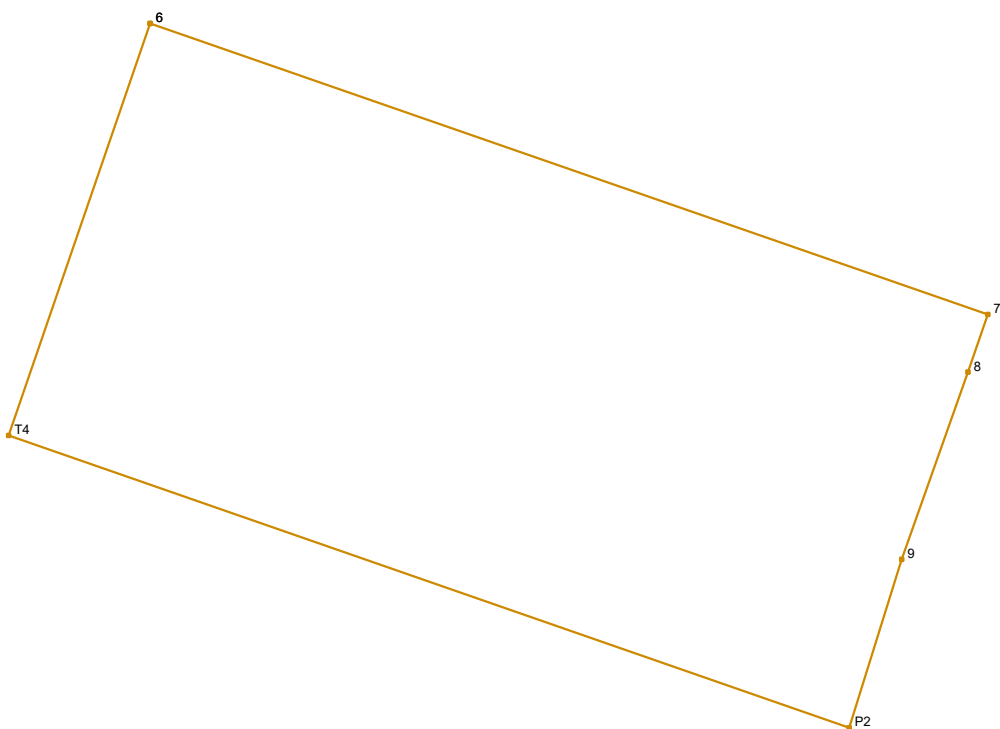

Νέα ιδιοκτησία εντός ΟΤ							
id1:1470		id2:03		Σημεία:6		Εμβαδό:1126.62 m <sup>2</sup>	
Σημείο	X	Y	μήκος	Σημείο	X	Y	μήκος
6	499221.613	3929173.051	47.89	P2	499259.357	3929135.017	48.05
7	499266.844	3929157.328	3.29	T4	499213.975	3929150.792	23.53
8	499265.774	3929154.216	10.73	6	499221.613	3929173.051	
9	499262.200	3929144.102	9.52				

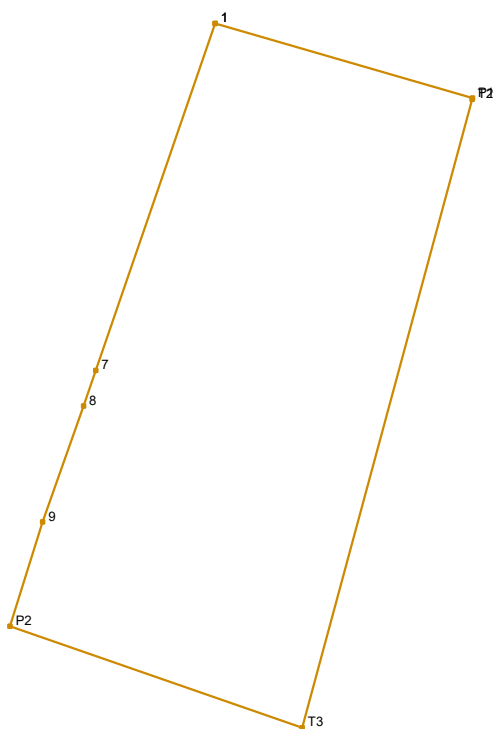

Νέα ιδιοκτησία εντός ΟΤ							
id1:1470		id2:04N		Σημεία:8		Εμβαδό:1418.60 m <sup>2</sup>	
Σημείο	X	Y	μήκος	Σημείο	X	Y	μήκος
1	499277.255	3929187.603		9	499262.200	3929144.102	
P1	499299.703	3929181.090	23.37	8	499265.774	3929154.216	10.73
T2	499299.662	3929180.975	0.12	7	499266.844	3929157.328	3.29
T3	499284.830	3929126.163	56.78	1	499277.255	3929187.603	32.01
P2	499259.357	3929135.017	26.97				
			9.52				

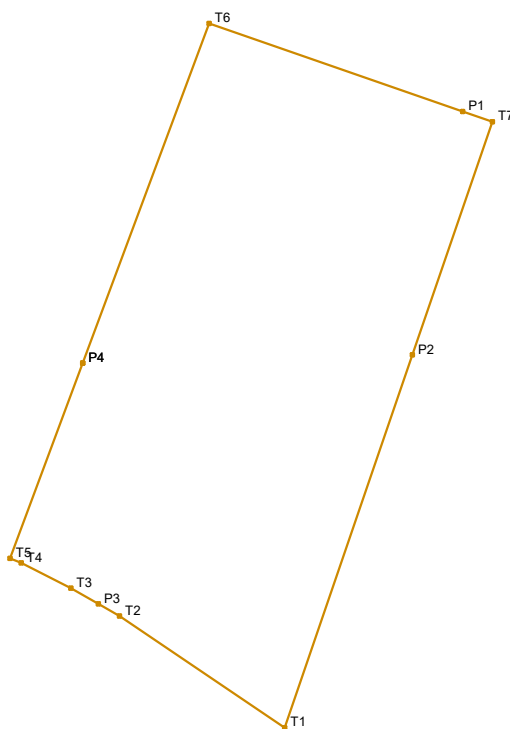

Νέα ιδιοκτησία εντός ΟΤ							
id1:1471		id2:01		Σημεία:11		Εμβαδό:3266.59 m <sup>2</sup>	
Σημείο	X	Y	μήκος	Σημείο	X	Y	μήκος
P4	499150.591	3929111.211	48.21	T2	499155.471	3929077.604	3.24
T6	499167.411	3929156.390		P3	499152.663	3929079.214	4.21
P1	499201.090	3929144.684	35.66	T3	499149.009	3929081.307	7.41
T7	499205.062	3929143.303	4.20	T4	499142.397	3929084.652	
P2	499194.427	3929112.308	32.77	T5	499140.932	3929085.265	1.59
T1	499177.423	3929062.751	52.39	P4	499150.591	3929111.211	27.69
			26.50				

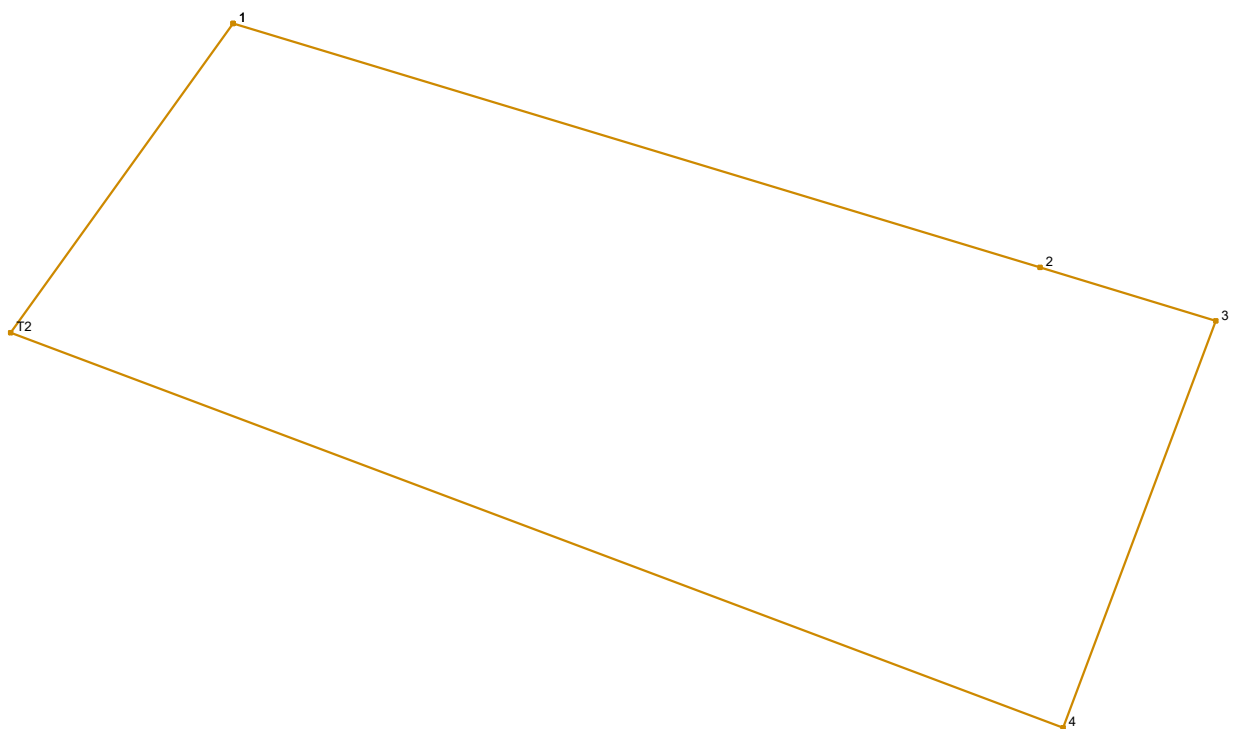

Νέα ιδιοκτησία εντός ΟΤ							
id1:1474		id2:01		Σημεία:5		Εμβαδό:730.43 m <sup>2</sup>	
Σημείο	X	Y	μήκος	Σημείο	X	Y	μήκος
1	499475.426	3928706.535	34.78	4	499509.663	3928677.482	46.36
2	499508.715	3928696.462		7.58	T2	499466.258	
3	499515.966	3928694.268	17.93	1	499475.426	3928706.535	

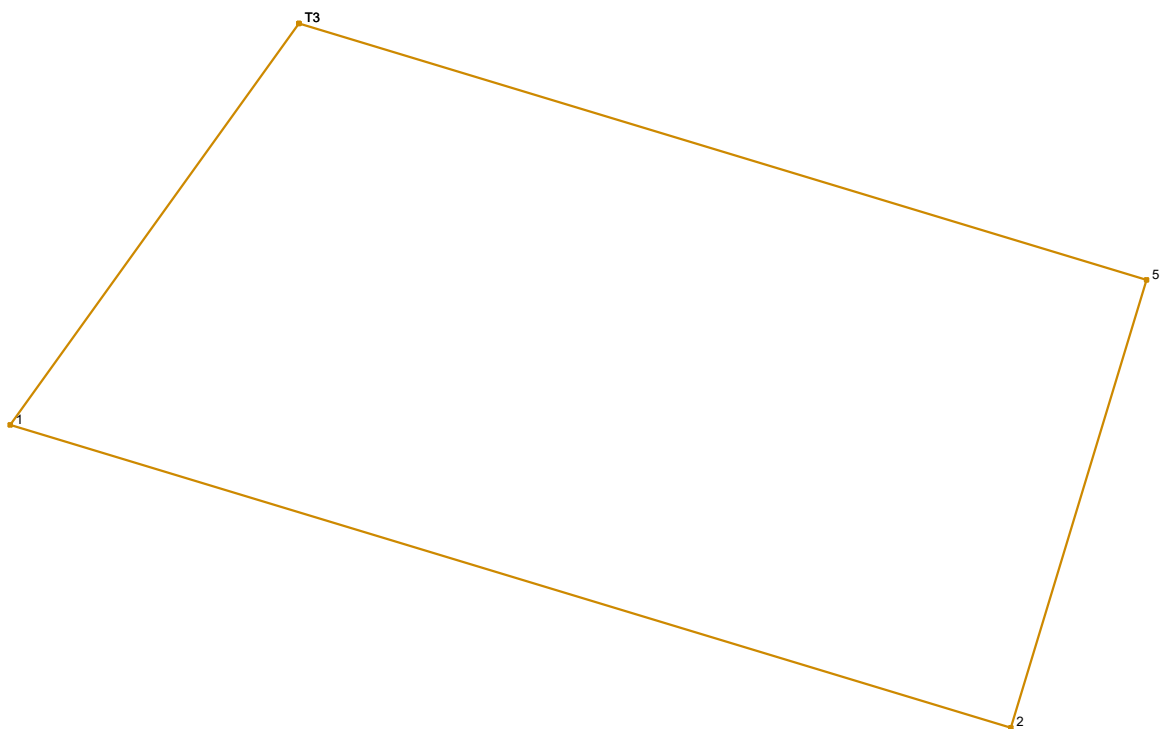

Νέα ιδιοκτησία εντός ΟΤ							
id1:1474		id2:02N		Σημεία:4		Εμβαδό:500.00 m <sup>2</sup>	
Σημείο	X	Y	μήκος	Σημείο	X	Y	μήκος
Τ3	499485.029	3928719.894	29.46	1	499475.426	3928706.535	16.45
5	499513.223	3928711.363		15.57	Τ3	499485.029	
2	499508.715	3928696.462	34.78				



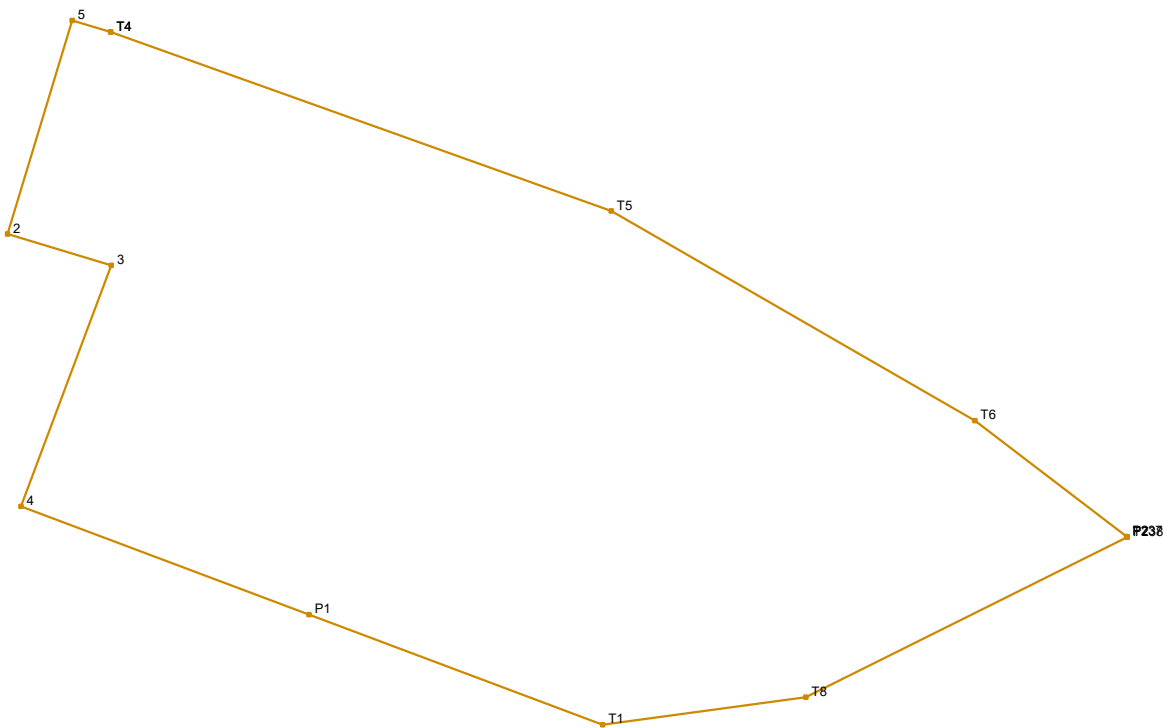

Νέα ιδιοκτησία εντός ΟΤ							
id1:1474		id2:03		Σημεία:13		Εμβαδό:2110.34 m <sup>2</sup>	
Σημείο	X	Y	μήκος	Σημείο	X	Y	μήκος
T4	499515.910	3928710.550		T1	499550.226	3928662.251	
			37.07				21.87
T5	499550.823	3928698.078		P1	499529.756	3928669.937	
			29.27				21.46
T6	499576.177	3928683.454		4	499509.663	3928677.482	
			13.31				17.93
P237	499586.752	3928675.374		3	499515.966	3928694.268	
			0.05				7.58
T7	499586.795	3928675.341		2	499508.715	3928696.462	
			0.01				15.57
P238	499586.785	3928675.336		5	499513.223	3928711.363	
			25.03				2.81
T8	499564.381	3928664.171		T4	499515.910	3928710.550	
			14.28				

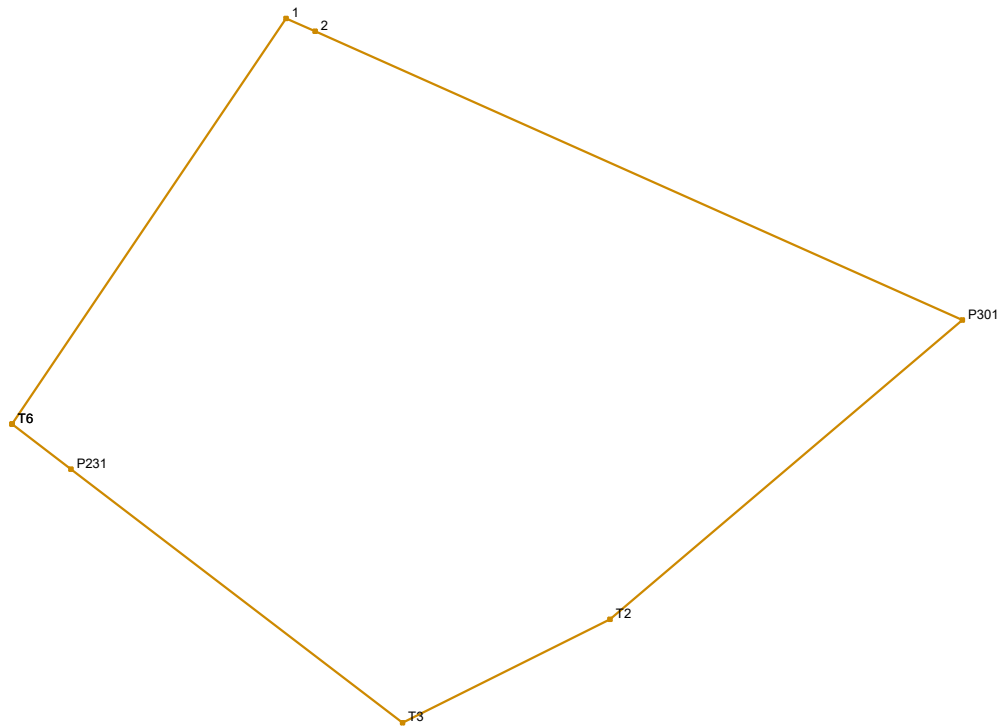

Νέα ιδιοκτησία εντός ΟΤ							
id1:1475		id2:01		Σημεία:7		Εμβαδό:381.27 m <sup>2</sup>	
Σημείο	X	Y	μήκος	Σημείο	X	Y	μήκος
T6	499581.944	3928689.116	16.08	T2	499601.579	3928682.708	7.61
1	499590.943	3928702.442	1.04	T3	499594.771	3928679.315	13.71
2	499591.894	3928702.018	23.28	P231	499583.876	3928687.639	2.43
P301	499613.153	3928692.539	15.19	T6	499581.944	3928689.116	

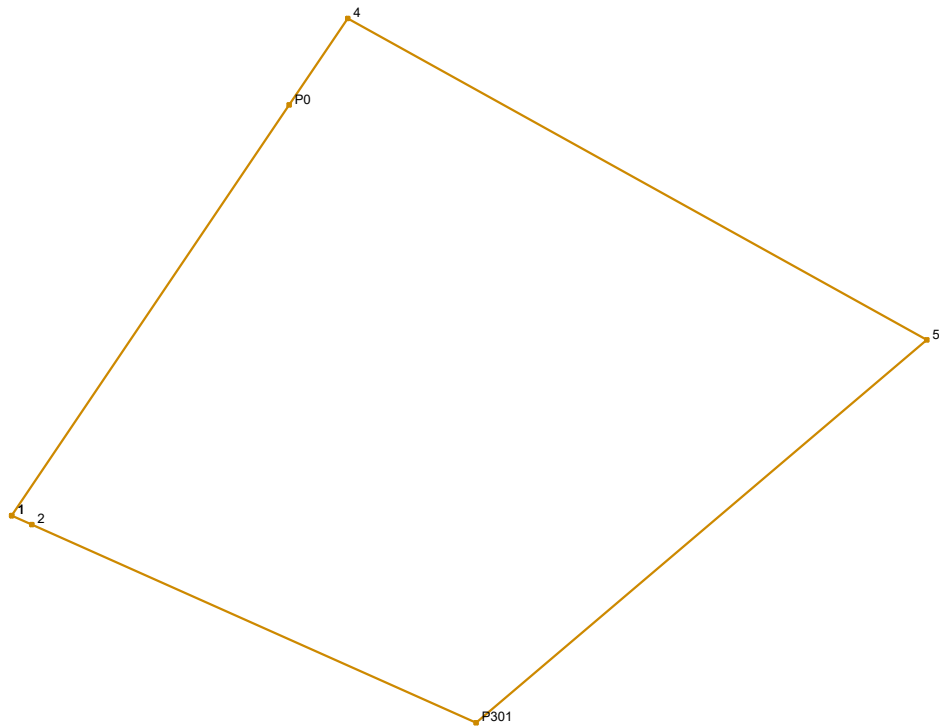

Νέα ιδιοκτησία εντός ΟΤ							
id1:1475		id2:02		Σημεία:6		Εμβαδό:763.56 m <sup>2</sup>	
Σημείο	X	Y	μήκος	Σημείο	X	Y	μήκος
1	499590.943	3928702.442	23.72	P301	499613.153	3928692.539	23.28
P0	499604.217	3928722.099		5.00	2	499591.894	
4	499607.014	3928726.240	31.69	1	499590.943	3928702.442	
5	499634.722	3928710.860	28.30				

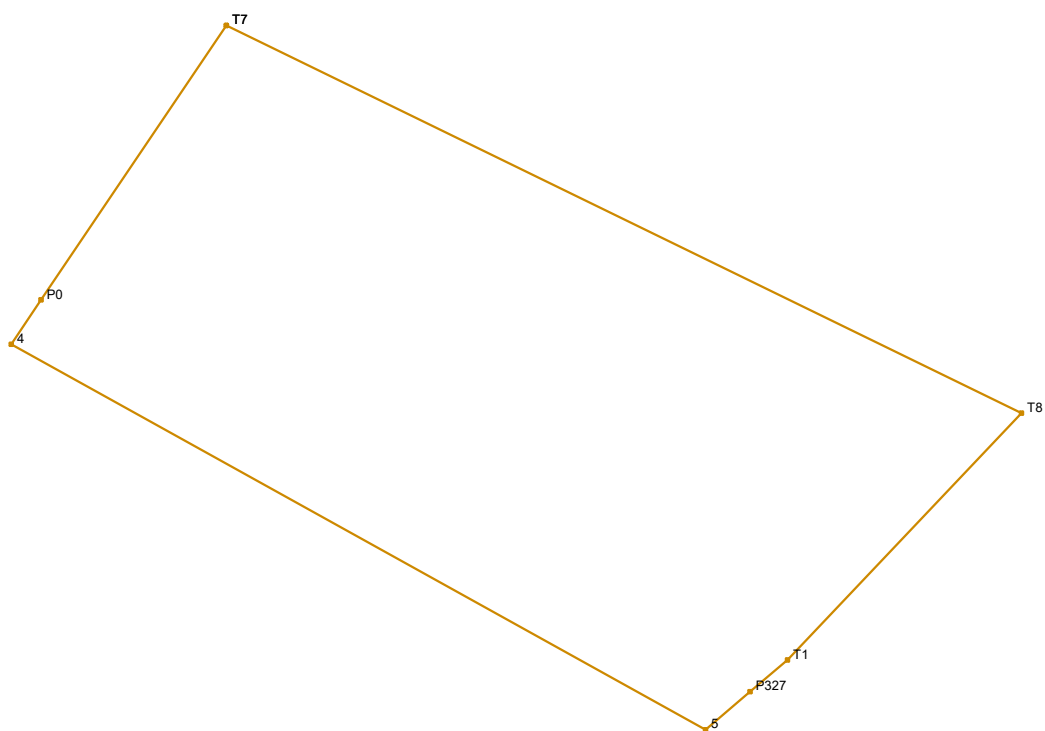

Νέα ιδιοκτησία εντός ΟΤ							
id1:1475		id2:03		Σημεία:7		Εμβαδό:543.45 m <sup>2</sup>	
Σημείο	X	Y	μήκος	Σημείο	X	Y	μήκος
T7	499615.609	3928738.968	35.30	5	499634.722	3928710.860	31.69
T8	499647.332	3928723.487		13.57	4	499607.014	
T1	499637.994	3928713.639	1.95		P0	499608.209	3928728.010
P327	499636.506	3928712.375		2.34	T7	499615.609	3928738.968

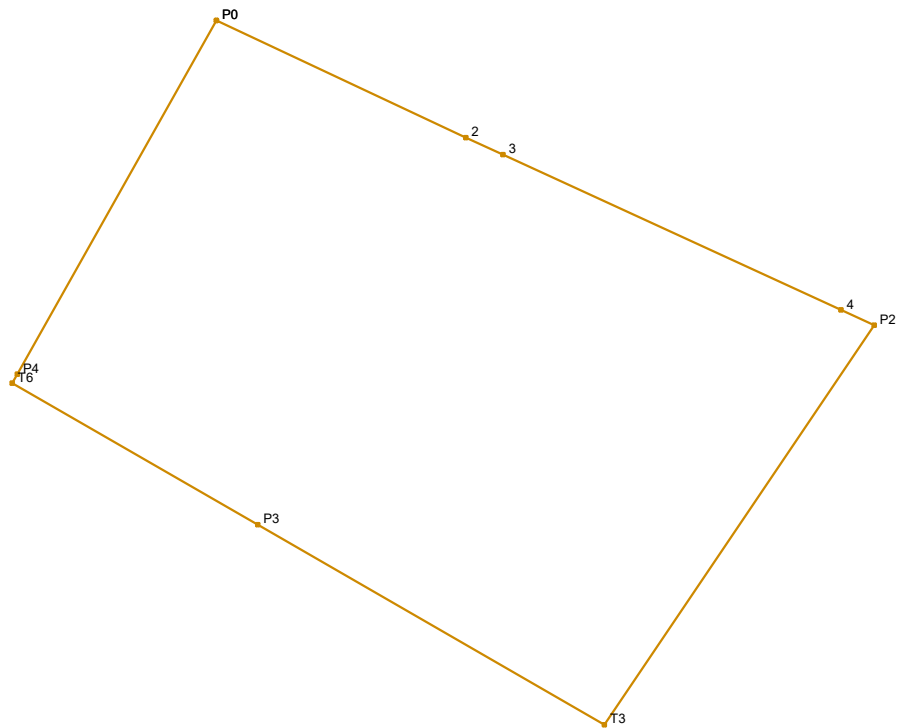

Νέα ιδιοκτησία εντός ΟΤ							
id1:1476		id2:01		Σημεία:9		Εμβαδό:416.87 m <sup>2</sup>	
Σημείο	X	Y	μήκος	Σημείο	X	Y	μήκος
P0	499562.720	3928717.952	10.04	T3	499576.853	3928692.299	14.57
2	499571.807	3928713.684	1.48	P3	499564.229	3928699.581	10.32
3	499573.153	3928713.065	13.55	T6	499555.286	3928704.739	0.37
4	499585.461	3928707.407	1.34	P4	499555.467	3928705.060	14.79
P2	499586.678	3928706.848	17.56	P0	499562.720	3928717.952	

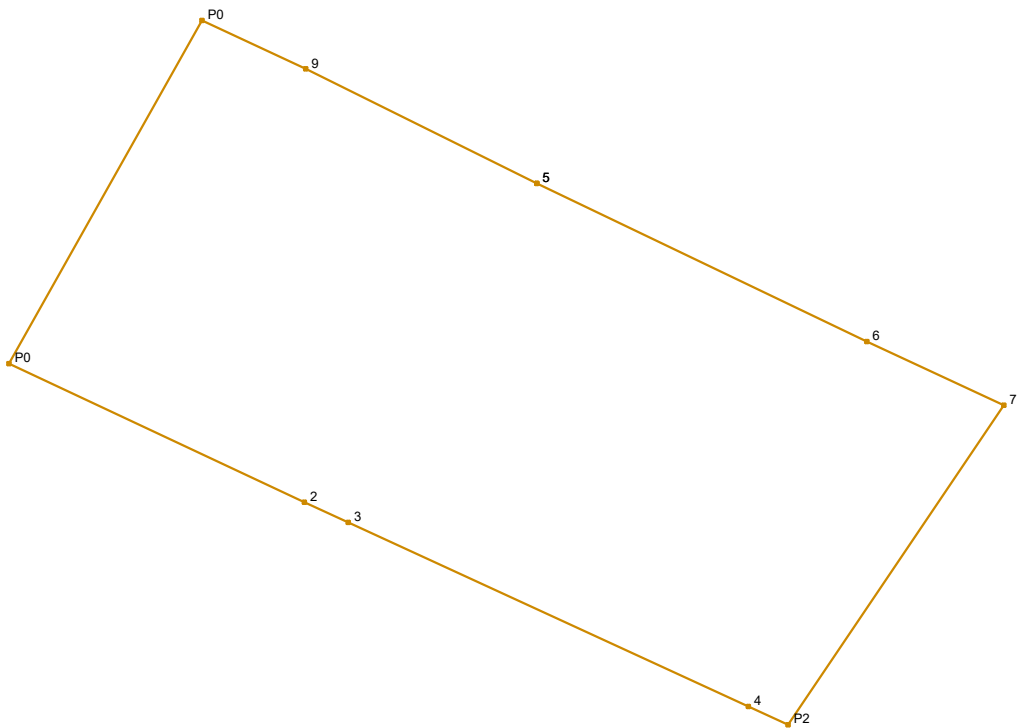

Νέα ιδιοκτησία εντός ΟΤ							
id1:1476		id2:02		Σημεία:10		Εμβαδό:319.49 m <sup>2</sup>	
Σημείο	X	Y	μήκος	Σημείο	X	Y	μήκος
5	499578.948	3928723.494	11.25	2	499571.807	3928713.684	10.04
6	499589.095	3928718.626	4.65	P0	499562.720	3928717.952	12.11
7	499593.309	3928716.667	11.85	P0	499568.657	3928728.505	3.52
P2	499586.678	3928706.848	1.34	9	499571.844	3928727.018	7.93
4	499585.461	3928707.407	13.55	5	499578.948	3928723.494	
3	499573.153	3928713.065	1.48				

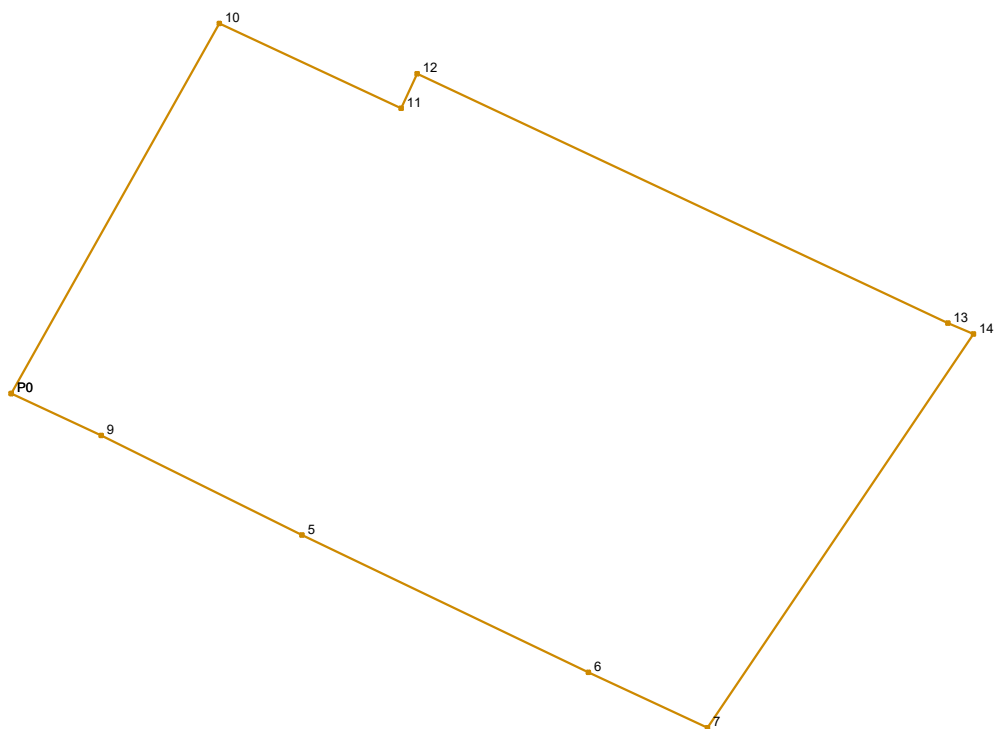

Νέα ιδιοκτησία εντός ΟΤ							
id1:1476		id2:03		Σημεία:10		Εμβαδό:453.33 m <sup>2</sup>	
Σημείο	X	Y	μήκος	Σημείο	X	Y	μήκος
P0	499568.657	3928728.505		7	499593.309	3928716.667	
			15.03				4.65
10	499576.027	3928741.606		6	499589.095	3928718.626	
			7.10				11.25
11	499582.459	3928738.599		5	499578.948	3928723.494	
			1.35				7.93
12	499583.031	3928739.818		9	499571.844	3928727.018	
			20.76				3.52
13	499601.821	3928730.996		P0	499568.657	3928728.505	
			0.98				
14	499602.720	3928730.603					
			16.82				

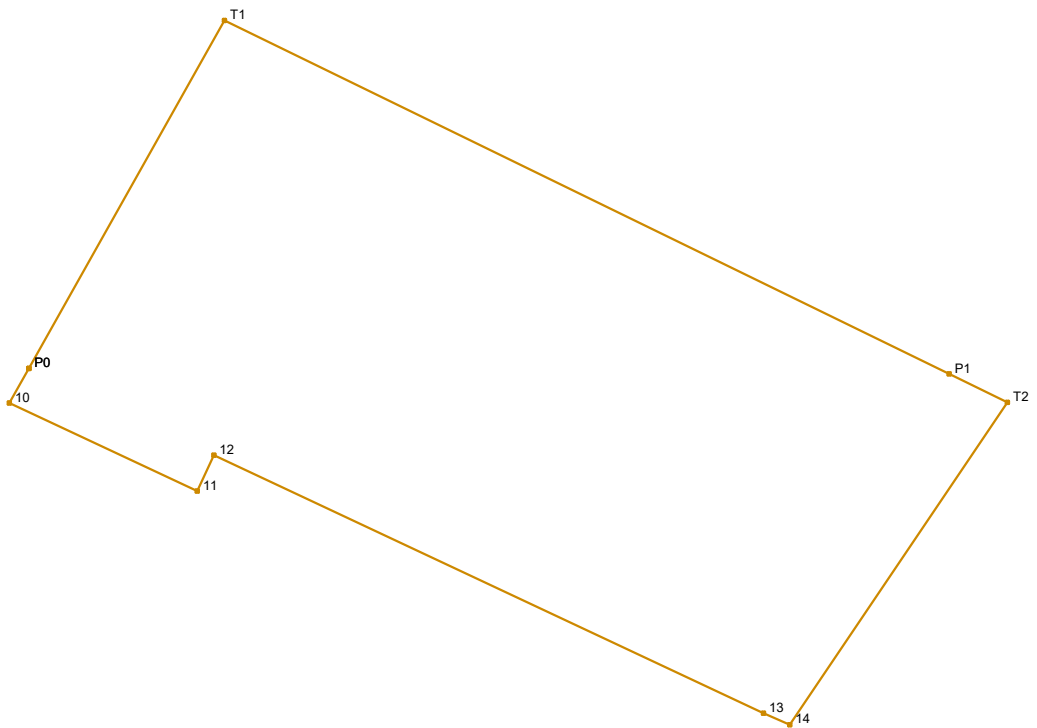

Νέα ιδιοκτησία εντός ΟΤ							
id1:1476		id2:04		Σημεία:9		Εμβαδό:401.73 m <sup>2</sup>	
Σημείο	X	Y	μήκος	Σημείο	X	Y	μήκος
P0	499576.695	3928742.792		13	499601.821	3928730.996	
			13.65				20.76
T1	499583.389	3928754.692		12	499583.031	3928739.818	
			27.57				1.35
P1	499608.167	3928742.600		11	499582.459	3928738.599	
			2.22				7.10
T2	499610.164	3928741.625		10	499576.027	3928741.606	
			13.30				1.36
14	499602.720	3928730.603		P0	499576.695	3928742.792	
			0.98				



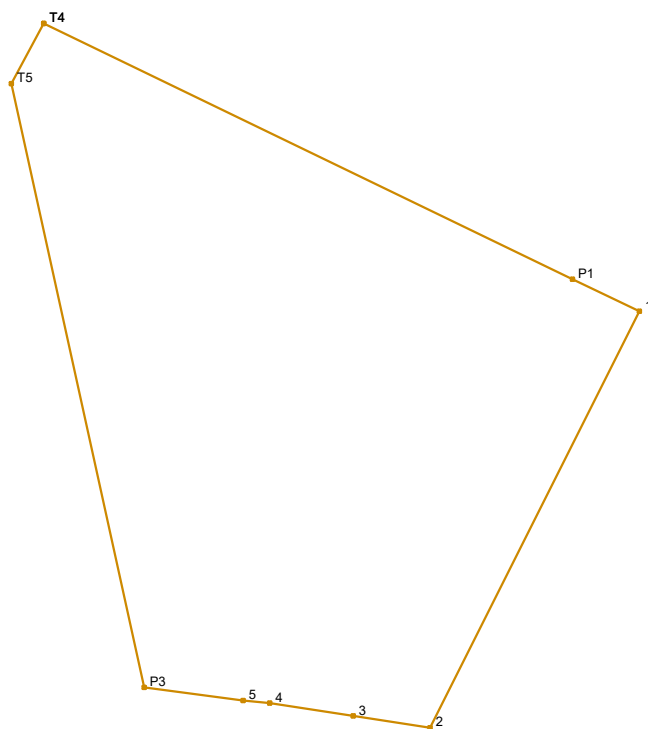

Νέα ιδιοκτησία εντός ΟΤ							
id1:1477		id2:01		Σημεία:9		Εμβαδό:500.00 m <sup>2</sup>	
Σημείο	X	Y	μήκος	Σημείο	X	Y	μήκος
T4	499478.900	3928801.221	25.74	4	499488.811	3928771.442	1.17
P1	499502.075	3928790.014		3.25	5	499487.650	3928771.554
1	499504.998	3928788.601	20.41	P3	499483.313	3928772.127	27.08
2	499495.839	3928770.362	3.41	T5	499477.490	3928798.577	
3	499492.467	3928770.880	3.70	T4	499478.900	3928801.221	

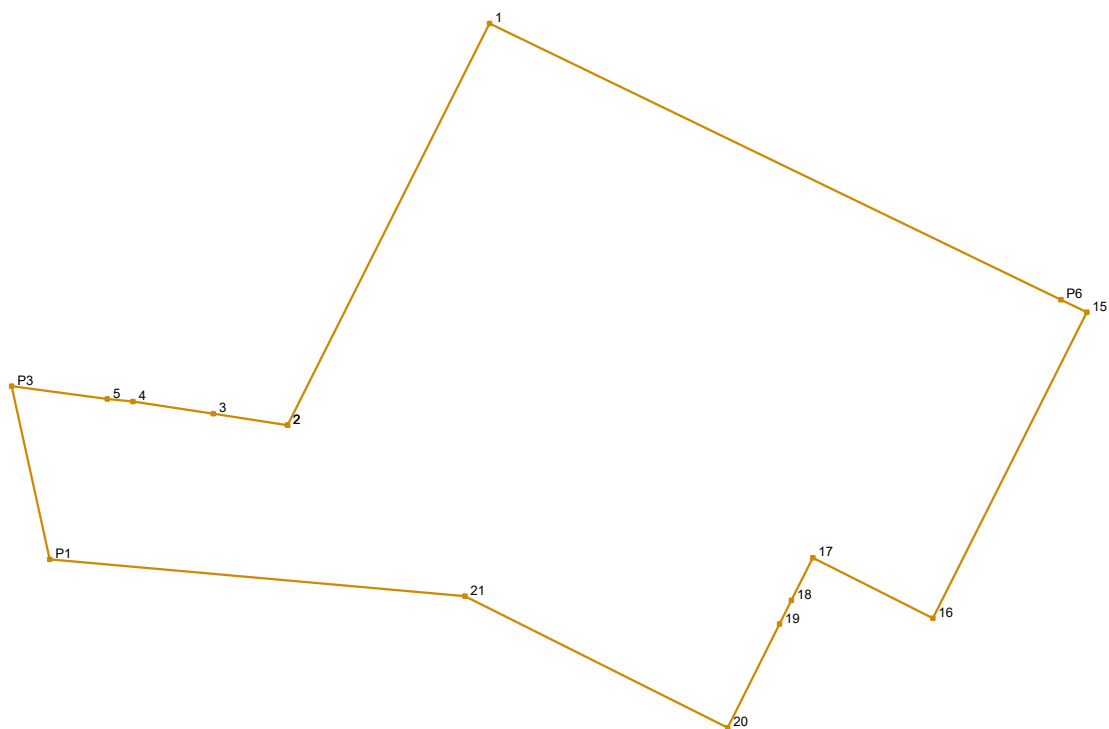

Νέα ιδιοκτησία εντός ΟΤ							
id1:1477		id2:02		Σημεία:15		Εμβαδό:765.09 m <sup>2</sup>	
Σημείο	X	Y	μήκος	Σημείο	X	Y	μήκος
2	499495.839	3928770.362	20.41	20	499515.801	3928756.633	13.33
1	499504.998	3928788.601	28.81	21	499503.884	3928762.608	18.92
P6	499530.931	3928776.060	1.31	P1	499485.042	3928764.275	8.04
15	499532.111	3928775.489	15.55	P3	499483.313	3928772.127	4.37
16	499525.115	3928761.598	6.10	5	499487.650	3928771.554	1.17
17	499519.667	3928764.342	2.15	4	499488.811	3928771.442	3.70
18	499518.702	3928762.418	1.20	3	499492.467	3928770.880	3.41
19	499518.163	3928761.345	5.27	2	499495.839	3928770.362	

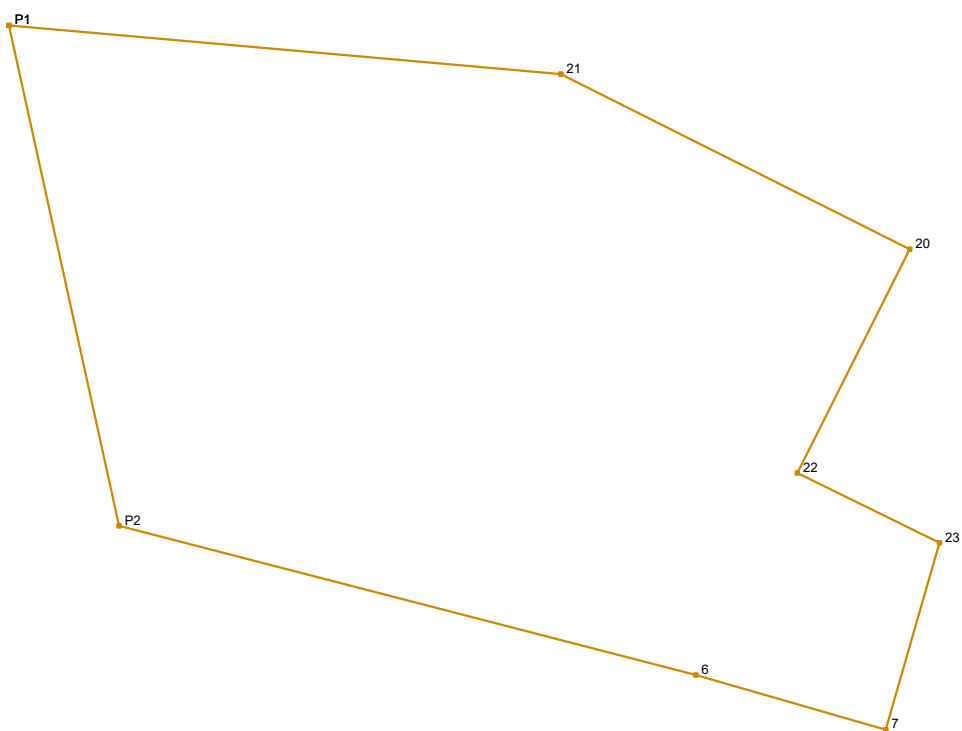

Νέα ιδιοκτησία εντός ΟΤ							
id1:1477		id2:03		Σημεία:8		Εμβαδό:500.00 m <sup>2</sup>	
Σημείο	X	Y	μήκος	Σημείο	X	Y	μήκος
P1	499485.042	3928764.275	18.92	7	499514.988	3928740.219	6.75
21	499503.884	3928762.608	13.33	6	499508.506	3928742.084	20.35
20	499515.801	3928756.633	8.56	P2	499488.804	3928747.187	17.50
22	499511.964	3928748.982	5.41	P1	499485.042	3928764.275	
23	499516.825	3928746.604	6.64				

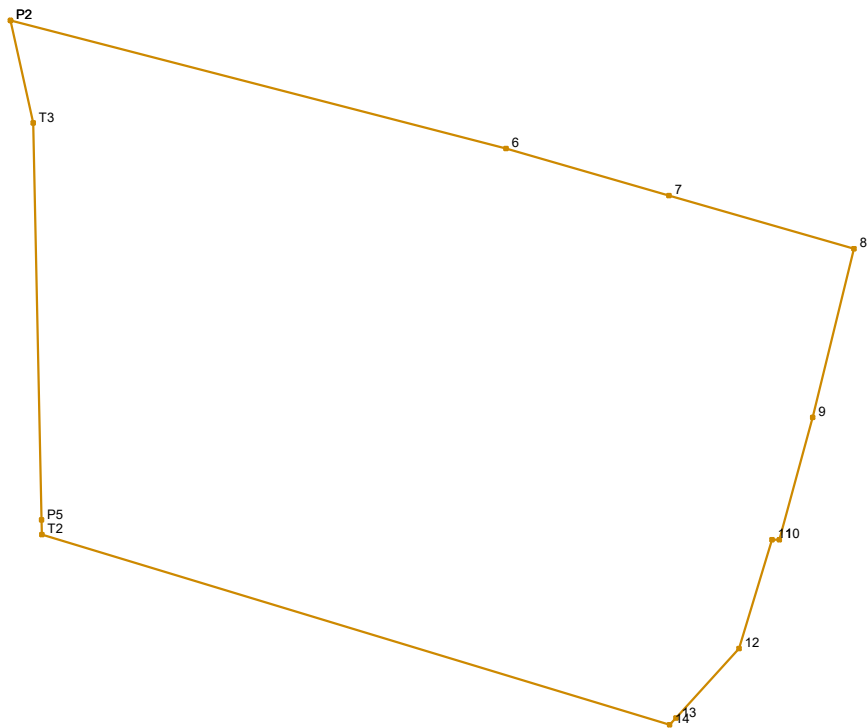

Νέα ιδιοκτησία εντός ΟΤ							
id1:1477		id2:04		Σημεία:13		Εμβαδό:616.11 m <sup>2</sup>	
Σημείο	X	Y	μήκος	Σημείο	X	Y	μήκος
P2	499488.804	3928747.187		12	499517.764	3928722.214	
			20.35				3.73
6	499508.506	3928742.084		13	499515.259	3928719.450	
			6.75				0.37
7	499514.988	3928740.219		14	499515.014	3928719.179	
			7.65				26.09
8	499522.341	3928738.103		T2	499490.045	3928726.735	
			6.90				0.59
9	499520.699	3928731.400		P5	499490.032	3928727.320	
			5.05				15.79
10	499519.369	3928726.531		T3	499489.704	3928743.103	
			0.29				4.18
11	499519.079	3928726.541		P2	499488.804	3928747.187	
			4.52				

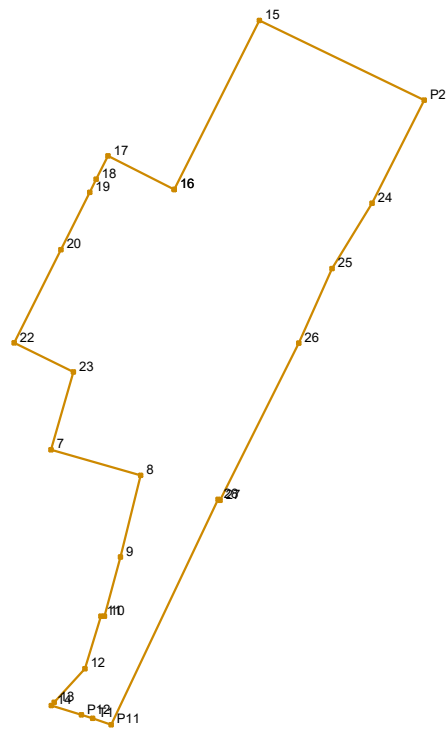

Νέα ιδιοκτησία εντός ΟΤ							
id1:1477		id2:05		Σημεία:25		Εμβαδό:771.61 m <sup>2</sup>	
Σημείο	X	Y	μήκος	Σημείο	X	Y	μήκος
16	499525.115	3928761.598	15.55	12	499517.764	3928722.214	4.52
15	499532.111	3928775.489	15.05	11	499519.079	3928726.541	0.29
P2	499545.660	3928768.937	9.50	10	499519.369	3928726.531	5.05
24	499541.376	3928760.462	6.31	9	499520.699	3928731.400	6.90
25	499538.077	3928755.081	6.70	8	499522.341	3928738.103	7.65
26	499535.344	3928748.964	14.45	7	499514.988	3928740.219	6.64
27	499528.872	3928736.047	0.19	23	499516.825	3928746.604	5.41
28	499528.702	3928736.142	20.51	22	499511.964	3928748.982	8.56
P11	499519.919	3928717.613	1.60	20	499515.801	3928756.633	5.27
T1	499518.416	3928718.150	0.98	19	499518.163	3928761.345	1.20
P12	499517.480	3928718.433	2.58	18	499518.702	3928762.418	2.15
14	499515.014	3928719.179	0.37	17	499519.667	3928764.342	6.10
13	499515.259	3928719.450	3.73	16	499525.115	3928761.598	

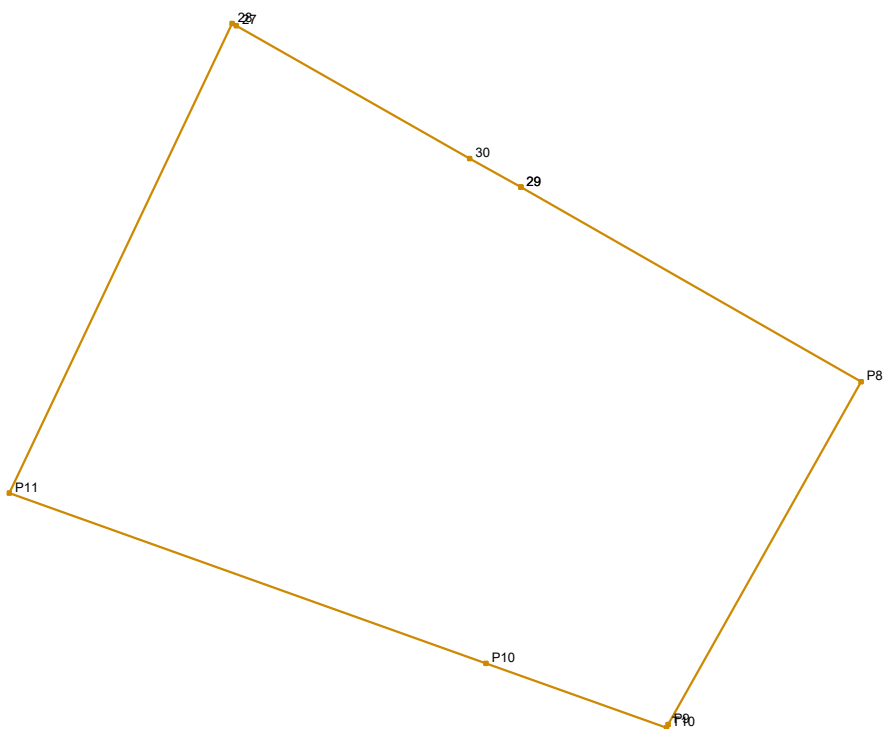

Νέα ιδιοκτησία εντός ΟΤ							
id1:1477		id2:06		Σημεία:9		Εμβαδό:504.87 m <sup>2</sup>	
Σημείο	X	Y	μήκος	Σημείο	X	Y	μήκος
29	499540.100	3928729.678	15.46	P11	499519.919	3928717.613	20.51
P8	499553.528	3928722.008	15.53	28	499528.702	3928736.142	0.19
P9	499545.912	3928708.472	0.14	27	499528.872	3928736.047	10.59
T10	499545.845	3928708.351	7.56	30	499538.074	3928730.805	2.32
P10	499538.722	3928710.896	19.97	29	499540.100	3928729.678	

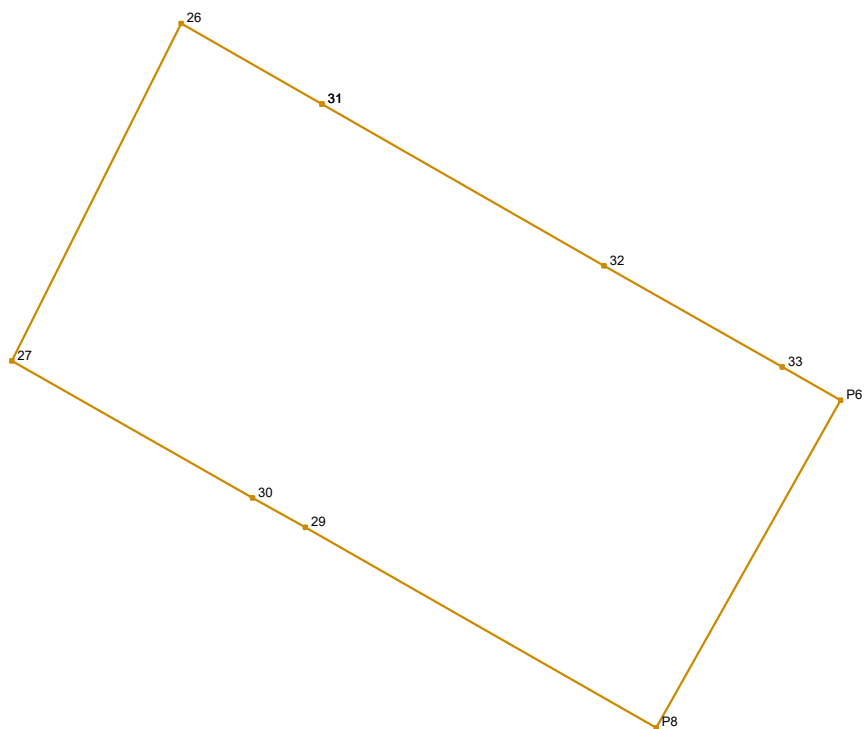

Νέα ιδιοκτησία εντός ΟΤ							
id1:1477		id2:07		Σημεία:9		Εμβαδό:413.18 m <sup>2</sup>	
Σημείο	X	Y	μήκος	Σημείο	X	Y	μήκος
31	499540.734	3928745.873	12.44	29	499540.100	3928729.678	2.32
32	499551.532	3928739.689		7.84	30	499538.074	
33	499558.350	3928735.814	2.57	27	499528.872	3928736.047	14.45
P6	499560.581	3928734.545		14.39	26	499535.344	
P8	499553.528	3928722.008	15.46	31	499540.734	3928745.873	

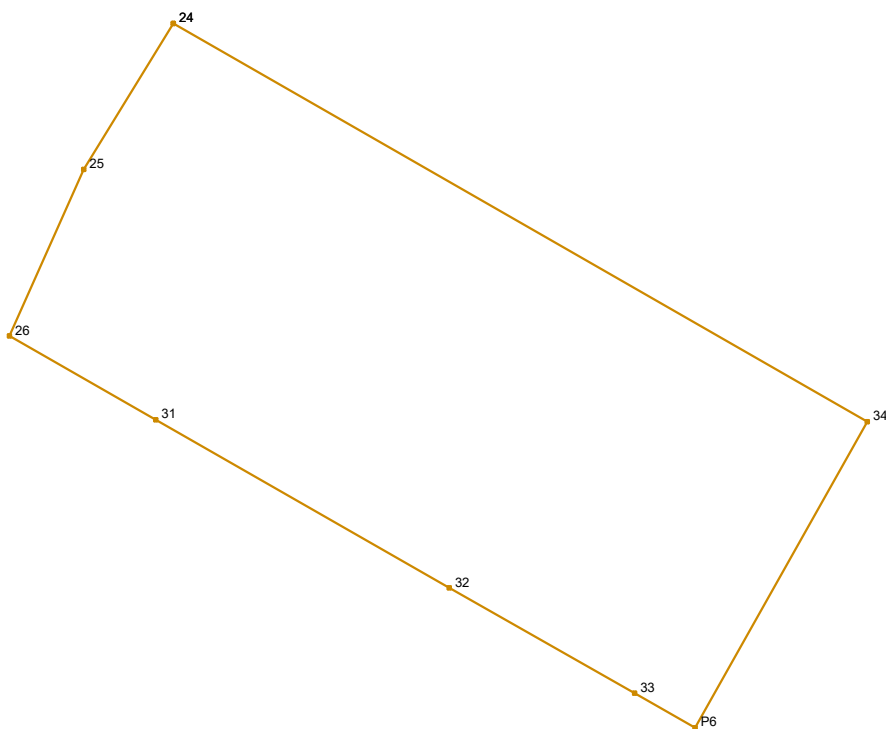

Νέα ιδιοκτησία εντός ΟΤ							
id1:1477		id2:08		Σημεία:8		Εμβαδό:381.82 m <sup>2</sup>	
Σημείο	X	Y	μήκος	Σημείο	X	Y	μήκος
24	499541.376	3928760.462		31	499540.734	3928745.873	6.21
34	499566.914	3928745.802	29.45	26	499535.344	3928748.964	6.70
P6	499560.581	3928734.545	12.92	25	499538.077	3928755.081	6.31
33	499558.350	3928735.814	2.57	24	499541.376	3928760.462	
32	499551.532	3928739.689	7.84				
			12.44				



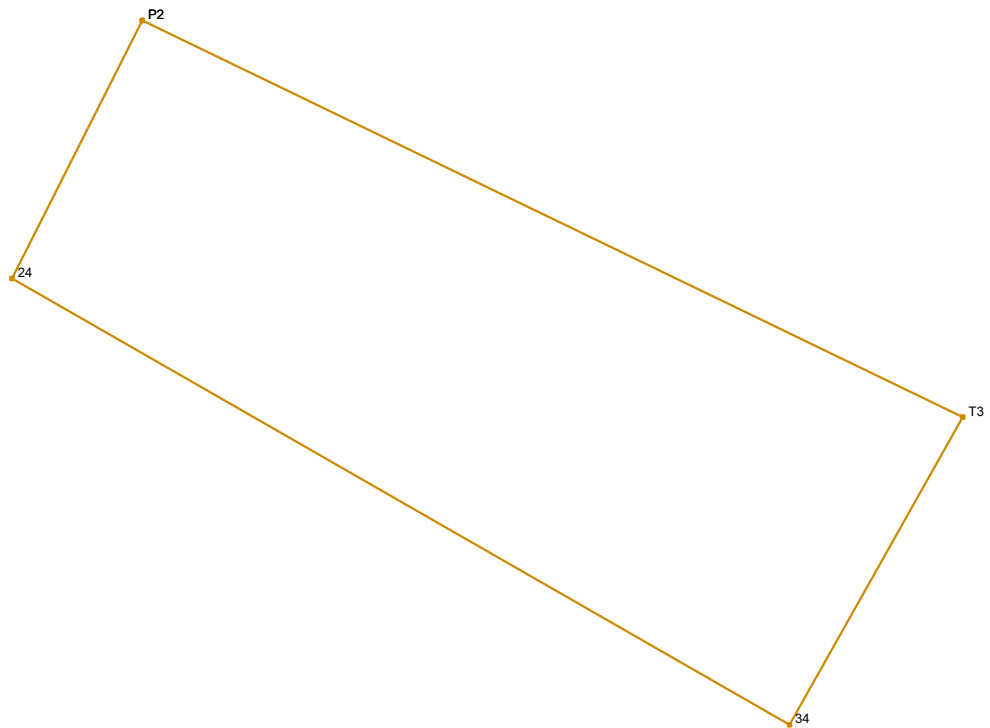

Νέα ιδιοκτησία εντός ΟΤ							
id1:1477		id2:09		Σημεία:4		Εμβαδό:312.81 m <sup>2</sup>	
Σημείο	X	Y	μήκος	Σημείο	X	Y	μήκος
P2	499545.660	3928768.937	29.93	24	499541.376	3928760.462	9.50
T3	499572.600	3928755.909		P2	499545.660	3928768.937	
34	499566.914	3928745.802	11.60				
			29.45				

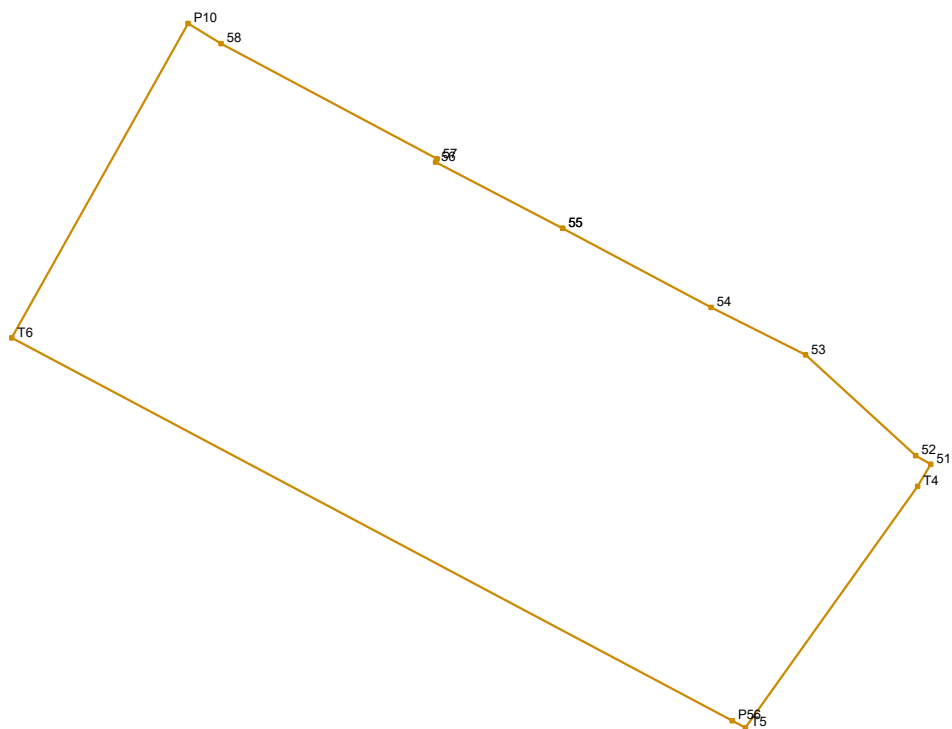

Νέα ιδιοκτησία εντός ΟΤ							
id1:1478		id2:01		Σημεία:13		Εμβαδό:1012.71 m <sup>2</sup>	
Σημείο	X	Y	μήκος	Σημείο	X	Y	μήκος
55	499695.280	3928739.121	9.78	P56	499705.143	3928710.496	47.45
54	499703.906	3928734.522	6.14	T6	499663.248	3928732.765	20.96
53	499709.399	3928731.772	8.67	P10	499673.492	3928751.046	2.26
52	499715.795	3928725.913	1.02	58	499675.411	3928749.858	14.24
51	499716.677	3928725.408	1.49	57	499687.978	3928743.158	0.20
T4	499715.916	3928724.127	17.24	56	499687.885	3928742.981	8.34
T5	499705.898	3928710.094	0.86	55	499695.280	3928739.121	

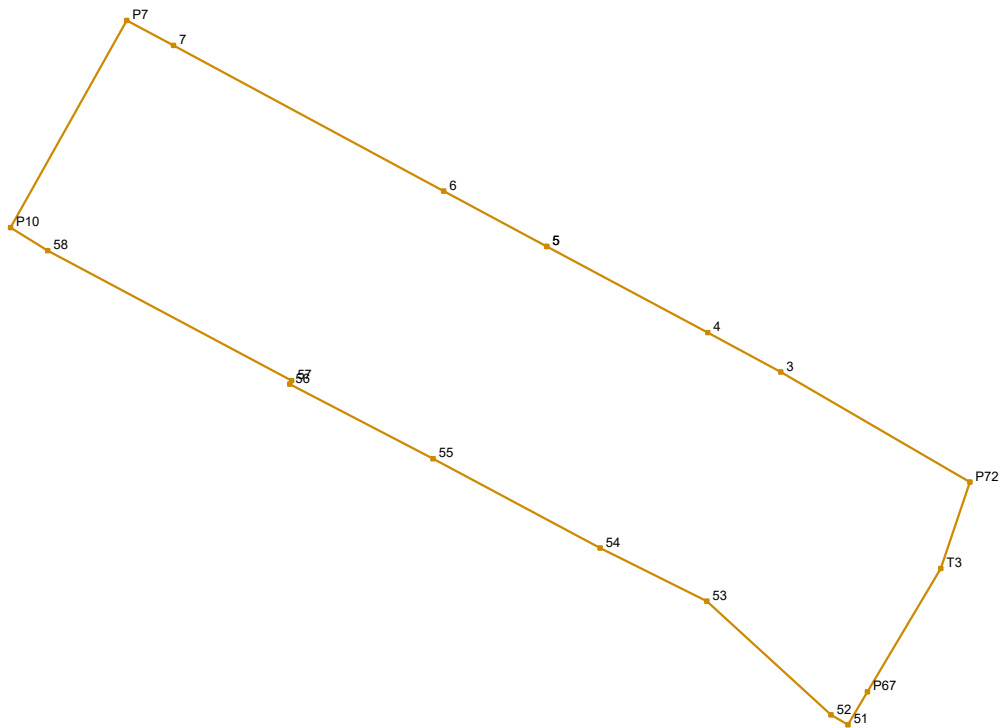

Νέα ιδιοκτησία εντός ΟΤ							
id1:1478		id2:02		Σημεία:18		Εμβαδό:629.45 m <sup>2</sup>	
Σημείο	X	Y	μήκος	Σημείο	X	Y	μήκος
5	499701.139	3928750.075	9.42	55	499695.280	3928739.121	8.34
4	499709.443	3928745.631	4.28	56	499687.885	3928742.981	0.20
3	499713.214	3928743.603	11.29	57	499687.978	3928743.158	14.24
P72	499722.971	3928737.914	4.69	58	499675.411	3928749.858	2.26
T3	499721.464	3928733.468	7.39	P10	499673.492	3928751.046	12.25
P67	499717.688	3928727.110	1.98	P7	499679.482	3928761.734	2.73
51	499716.677	3928725.408	1.02	7	499681.886	3928760.440	15.84
52	499715.795	3928725.913	8.67	6	499695.832	3928752.933	6.03
53	499709.399	3928731.772	6.14	5	499701.139	3928750.075	
54	499703.906	3928734.522	9.78				

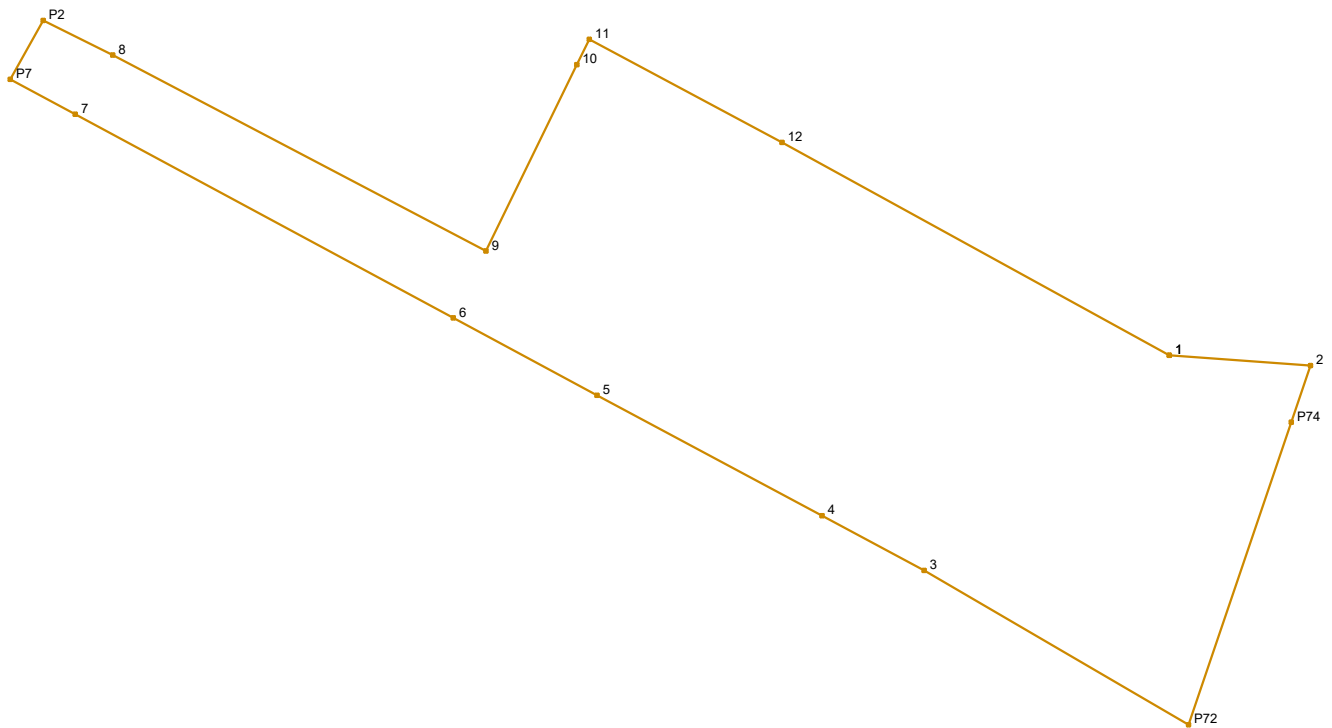

Νέα ιδιοκτησία εντός ΟΤ							
id1:1478		id2:03		Σημεία:16		Εμβαδό:400.00 m <sup>2</sup>	
Σημείο	X	Y	μήκος	Σημείο	X	Y	μήκος
1	499722.265	3928751.549	5.21	P7	499679.482	3928761.734	2.49
2	499727.466	3928751.173	2.21	P2	499680.700	3928763.908	2.86
P74	499726.756	3928749.080	11.79	8	499683.260	3928762.625	15.56
P72	499722.971	3928737.914	11.29	9	499697.037	3928755.399	7.65
3	499713.214	3928743.603	4.28	10	499700.397	3928762.275	1.03
4	499709.443	3928745.631	9.42	11	499700.849	3928763.201	8.07
5	499701.139	3928750.075	6.03	12	499707.971	3928759.405	16.31
6	499695.832	3928752.933	15.84	1	499722.265	3928751.549	
7	499681.886	3928760.440	2.73				

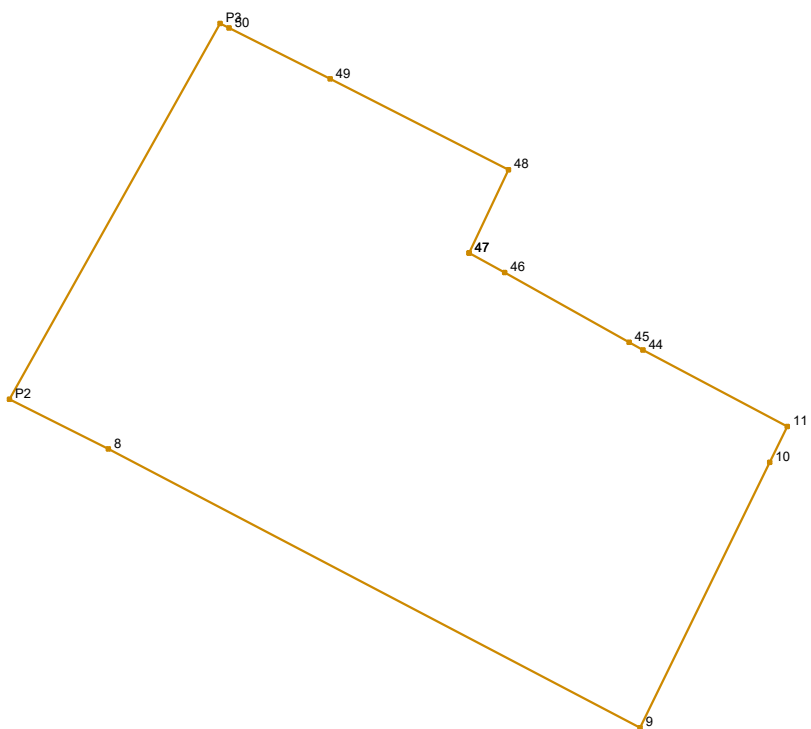

Νέα ιδιοκτησία εντός ΟΤ							
id1:1478		id2:04		Σημεία:13		Εμβαδό:179.37 m <sup>2</sup>	
Σημείο	X	Y	μήκος	Σημείο	X	Y	μήκος
47	499692.607	3928767.694	1.05	8	499683.260	3928762.625	2.86
46	499693.531	3928767.189		3.70	P2	499680.700	3928763.908
45	499696.757	3928765.382	0.41		P3	499686.157	3928773.648
44	499697.115	3928765.183		4.23	50	499686.393	3928773.526
11	499700.849	3928763.201	1.03		49	499689.007	3928772.211
10	499700.397	3928762.275		7.65	48	499693.626	3928769.851
9	499697.037	3928755.399	15.56		47	499692.607	3928767.694

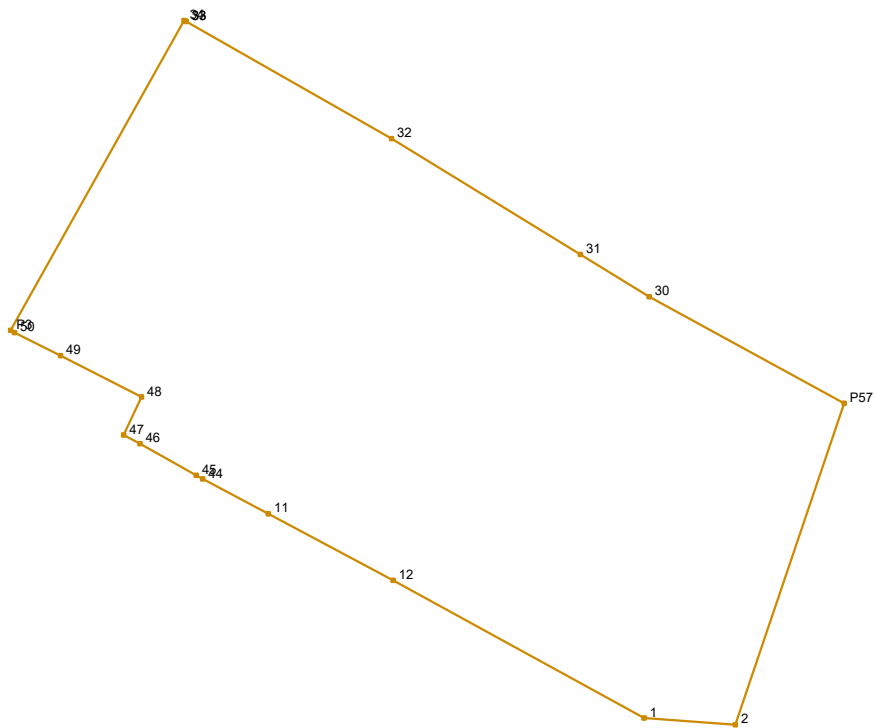

Νέα ιδιοκτησία εντός ΟΤ							
id1:1478		id2:05		Σημεία:18		Εμβαδό:961.68 m <sup>2</sup>	
Σημείο	X	Y	μήκος	Σημείο	X	Y	μήκος
33	499696.162	3928791.266		45	499696.757	3928765.382	
			13.49				3.70
32	499707.874	3928784.579		46	499693.531	3928767.189	
			12.63				1.05
31	499718.636	3928777.977		47	499692.607	3928767.694	
			4.62				2.39
30	499722.572	3928775.562		48	499693.626	3928769.851	
			12.65				5.19
P57	499733.677	3928769.497		49	499689.007	3928772.211	
			19.35				2.93
2	499727.466	3928751.173		50	499686.393	3928773.526	
			5.21				0.27
1	499722.265	3928751.549		P3	499686.157	3928773.648	
			16.31				20.26
12	499707.971	3928759.405		34	499696.062	3928791.323	
			8.07				0.12
11	499700.849	3928763.201		33	499696.162	3928791.266	
			4.23				
44	499697.115	3928765.183					
			0.41				

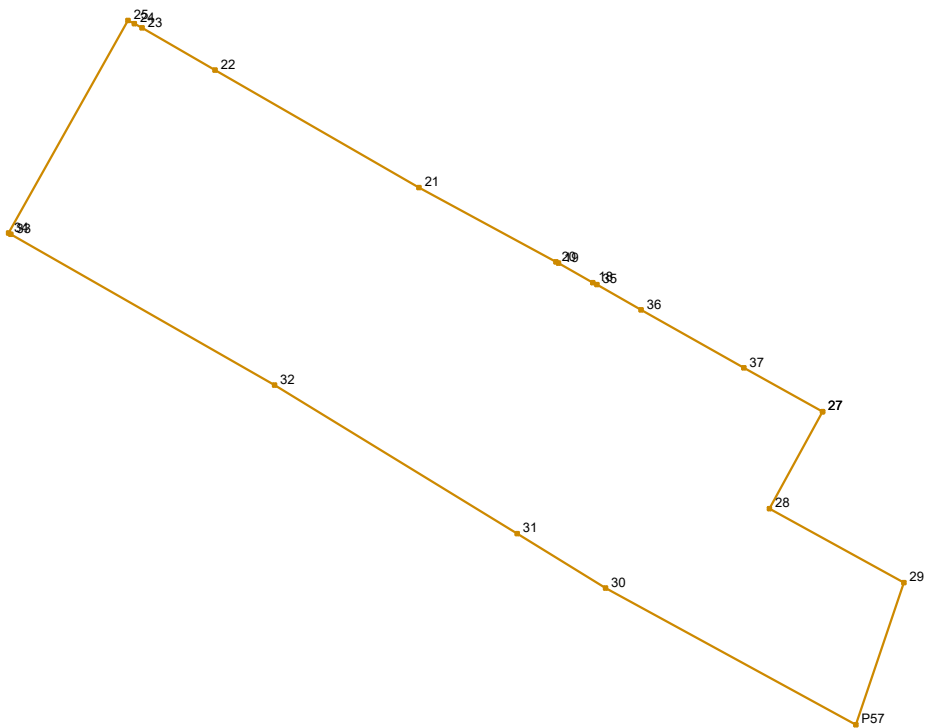

Νέα ιδιοκτησία εντός ΟΤ							
id1:1478		id2:06		Σημεία:20		Εμβαδό:441.71 m <sup>2</sup>	
Σημείο	X	Y	μήκος	Σημείο	X	Y	μήκος
27	499732.204	3928783.399		23	499701.978	3928800.437	
			4.92				3.75
28	499729.837	3928779.085		22	499705.231	3928798.561	
			6.82				10.45
29	499735.815	3928775.804		21	499714.283	3928793.341	
			6.66				6.91
P57	499733.677	3928769.497		20	499720.357	3928790.052	
			12.65				0.13
30	499722.572	3928775.562		19	499720.472	3928789.990	
			4.62				1.76
31	499718.636	3928777.977		18	499722.001	3928789.125	
			12.63				0.20
32	499707.874	3928784.579		35	499722.178	3928789.033	
			13.49				2.26
33	499696.162	3928791.266		36	499724.138	3928787.917	
			0.12				5.24
34	499696.062	3928791.323		37	499728.709	3928785.345	
			10.83				4.00
25	499701.357	3928800.772		27	499732.204	3928783.399	
			0.32				
24	499701.639	3928800.621					
			0.39				

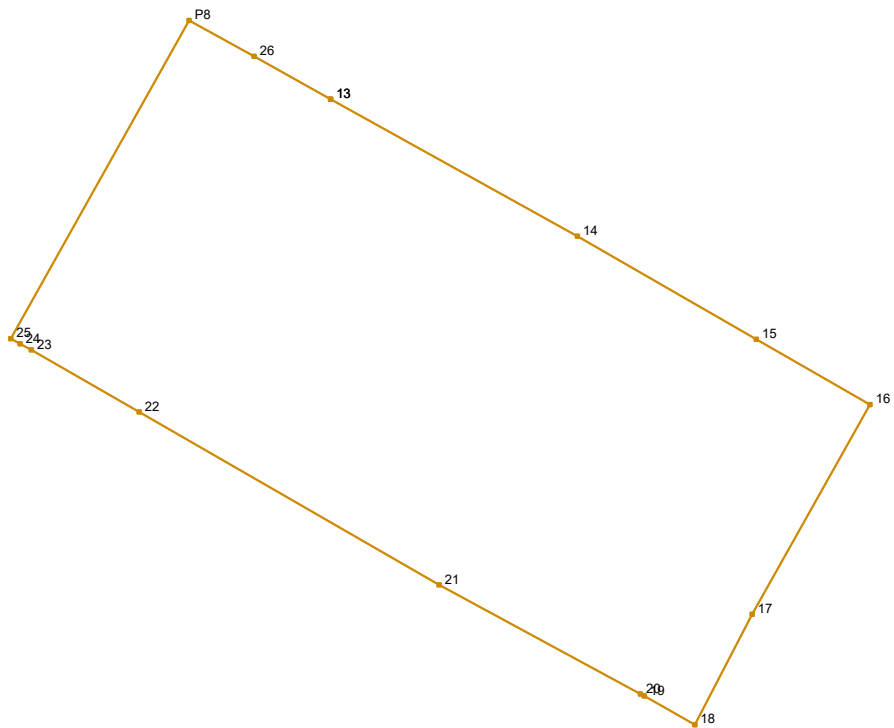

Νέα ιδιοκτησία εντός ΟΤ							
id1:1478		id2:07		Σημεία:15		Εμβαδό:261.94 m <sup>2</sup>	
Σημείο	X	Y	μήκος	Σημείο	X	Y	μήκος
13	499711.012	3928807.996	8.51	21	499714.283	3928793.341	10.45
14	499718.455	3928803.864	6.23	22	499705.231	3928798.561	3.75
15	499723.852	3928800.748	3.95	23	499701.978	3928800.437	0.39
16	499727.279	3928798.786	7.26	24	499701.639	3928800.621	0.32
17	499723.729	3928792.458	3.75	25	499701.357	3928800.772	11.01
18	499722.001	3928789.125	1.76	P8	499706.738	3928810.376	2.24
19	499720.472	3928789.990	0.13	26	499708.697	3928809.285	2.65
20	499720.357	3928790.052	6.91	13	499711.012	3928807.996	



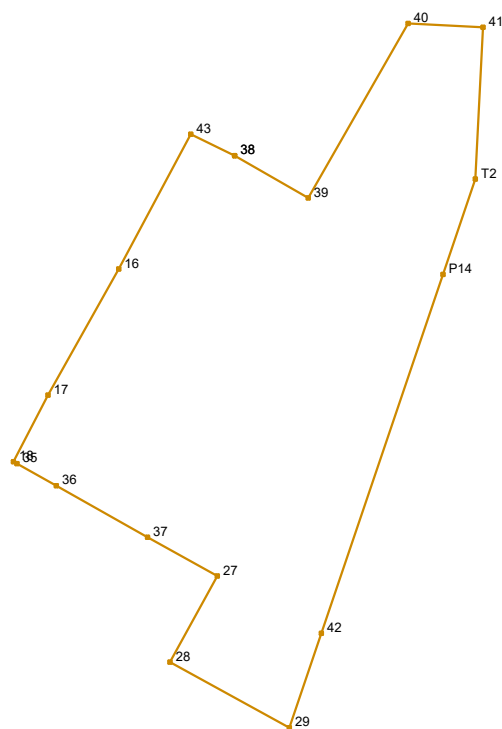

Νέα ιδιοκτησία εντός ΟΤ							
id1:1478		id2:08		Σημεία:17		Εμβαδό:400.00 m <sup>2</sup>	
Σημείο	X	Y	μήκος	Σημείο	X	Y	μήκος
38	499733.074	3928804.456	4.25	27	499732.204	3928783.399	4.00
39	499736.762	3928802.344		10.07	37	499728.709	3928785.345
40	499741.766	3928811.083	3.76	36	499724.138	3928787.917	2.26
41	499745.522	3928810.890	7.61	35	499722.178	3928789.033	0.20
T2	499745.131	3928803.288	5.05	18	499722.001	3928789.125	3.75
P14	499743.509	3928798.504	18.97	17	499723.729	3928792.458	7.26
42	499737.419	3928780.537	5.00	16	499727.279	3928798.786	7.65
29	499735.815	3928775.804	6.82	43	499730.874	3928805.536	2.45
28	499729.837	3928779.085	4.92	38	499733.074	3928804.456	

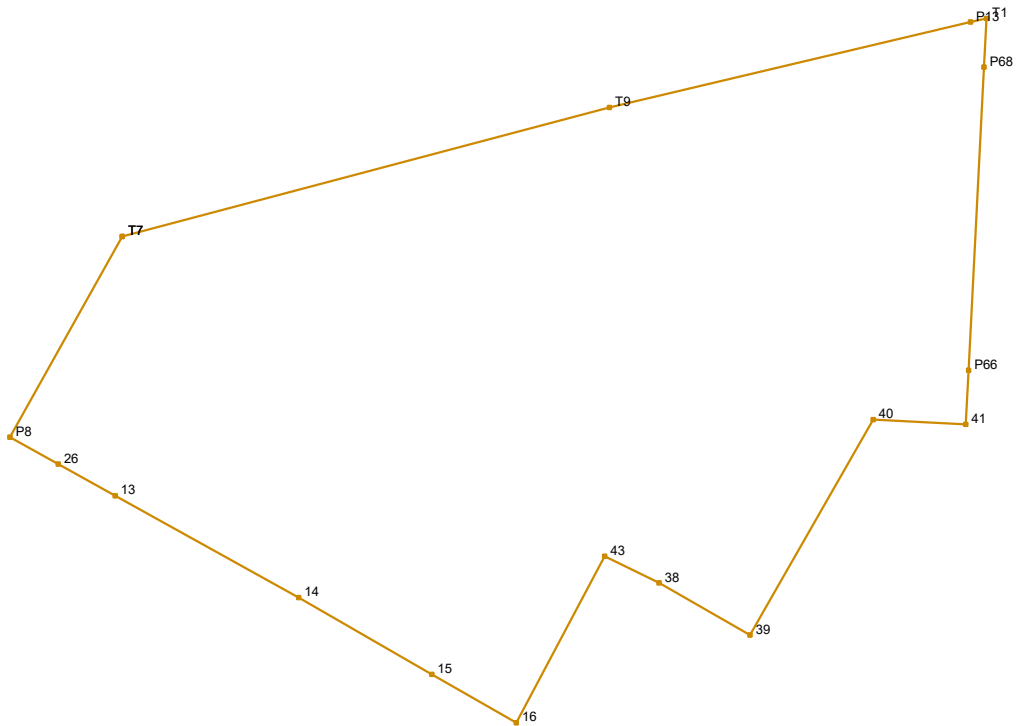

Νέα ιδιοκτησία εντός ΟΤ							
id1:1478		id2:09		Σημεία:17		Εμβαδό:657.29 m <sup>2</sup>	
Σημείο	X	Y	μήκος	Σημείο	X	Y	μήκος
T7	499711.300	3928818.517		38	499733.074	3928804.456	
T9	499731.064	3928823.746	20.44	43	499730.874	3928805.536	2.45
P13	499745.714	3928827.214	15.06	16	499727.279	3928798.786	7.65
T1	499746.370	3928827.369	0.67	15	499723.852	3928800.748	3.95
P68	499746.268	3928825.384	1.99	15	499723.852	3928800.748	6.23
P66	499745.635	3928813.091	12.31	14	499718.455	3928803.864	8.51
41	499745.522	3928810.890	2.20	13	499711.012	3928807.996	2.65
40	499741.766	3928811.083	3.76	26	499708.697	3928809.285	2.24
39	499736.762	3928802.344	10.07	P8	499706.738	3928810.376	9.33
			4.25	T7	499711.300	3928818.517	

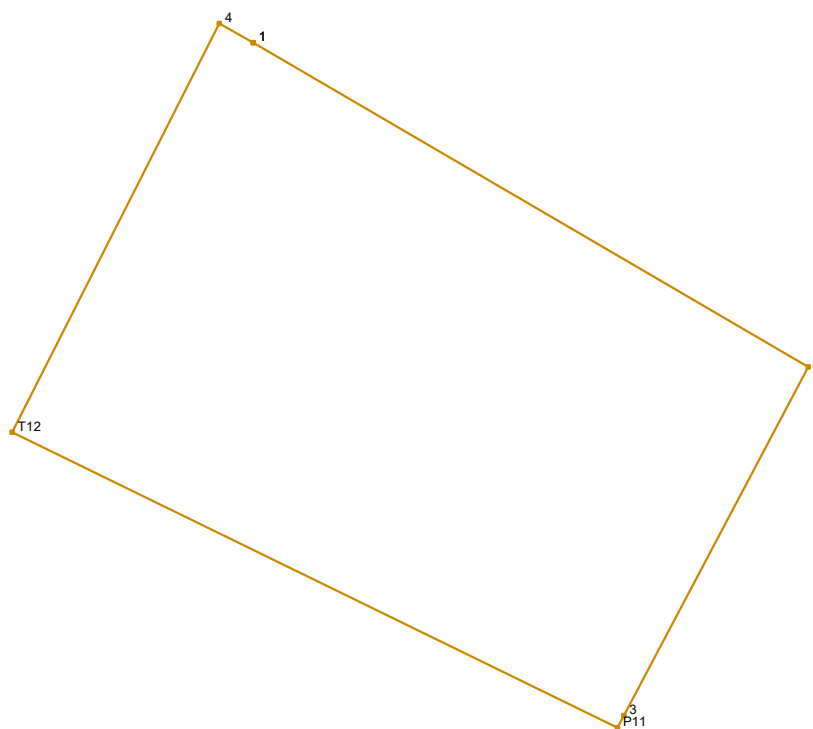

Νέα ιδιοκτησία εντός ΟΤ							
id1:1479		id2:01		Σημεία:6		Εμβαδό:202.39 m <sup>2</sup>	
Σημείο	X	Y	μήκος	Σημείο	X	Y	μήκος
1	499594.932	3928775.732	16.89	T12	499588.605	3928765.499	12.04
2	499609.511	3928767.214	10.36	4	499594.043	3928776.237	1.02
3	499604.665	3928758.057	0.36	1	499594.932	3928775.732	
P11	499604.502	3928757.742	17.69				

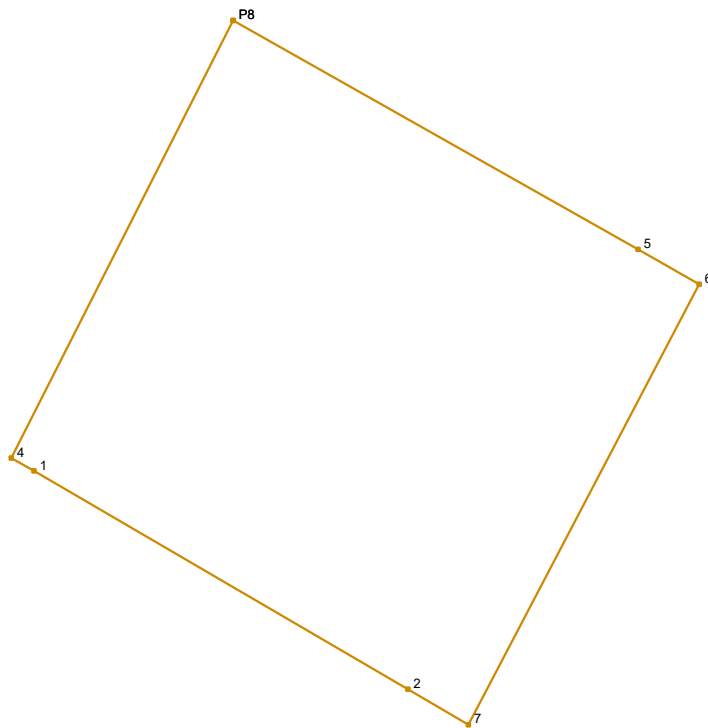

Νέα ιδιοκτησία εντός ΟΤ							
id1:1479		id2:02		Σημεία:7		Εμβαδό:400.00 m <sup>2</sup>	
Σημείο	X	Y	μήκος	Σημείο	X	Y	μήκος
P8	499602.691	3928793.315	18.16	2	499609.511	3928767.214	16.89
5	499618.498	3928784.374	2.75	1	499594.932	3928775.732	1.02
6	499620.888	3928783.022	19.41	4	499594.043	3928776.237	19.14
7	499611.882	3928765.828	2.75	P8	499602.691	3928793.315	

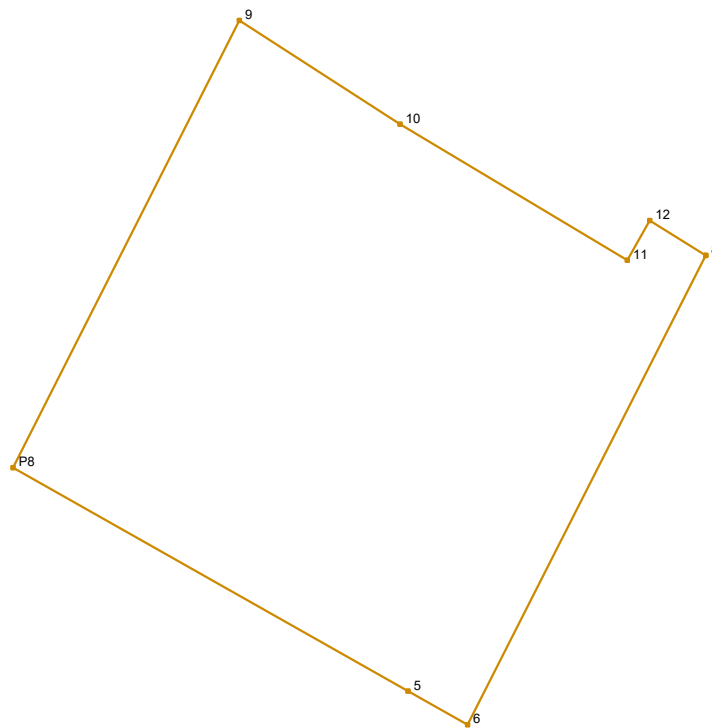

Νέα ιδιοκτησία εντός ΟΤ							
id1:1479		id2:03		Σημεία:8		Εμβαδό:414.01 m <sup>2</sup>	
Σημείο	X	Y	μήκος	Σημείο	X	Y	μήκος
8	499630.416	3928801.803	21.06	10	499618.183	3928807.054	10.60
6	499620.888	3928783.022	2.75	11	499627.281	3928801.611	1.82
5	499618.498	3928784.374	18.16	12	499628.179	3928803.199	2.64
P8	499602.691	3928793.315	20.06	8	499630.416	3928801.803	
9	499611.755	3928811.216	7.66				

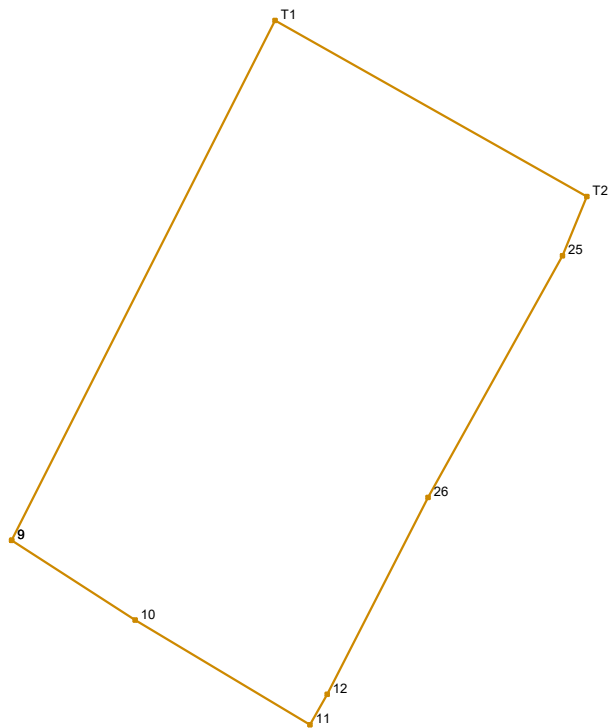

Νέα ιδιοκτησία εντός ΟΤ							
id1:1479		id2:04		Σημεία:8		Εμβαδό:569.17 m <sup>2</sup>	
Σημείο	X	Y	μήκος	Σημείο	X	Y	μήκος
9	499611.755	3928811.216	30.33	12	499628.179	3928803.199	1.82
T1	499625.459	3928838.278		18.65	11	499627.281	
T2	499641.697	3928829.105	3.34	10	499618.183	3928807.054	7.66
25	499640.422	3928826.015		14.38	9	499611.755	
26	499633.433	3928813.444	11.51				

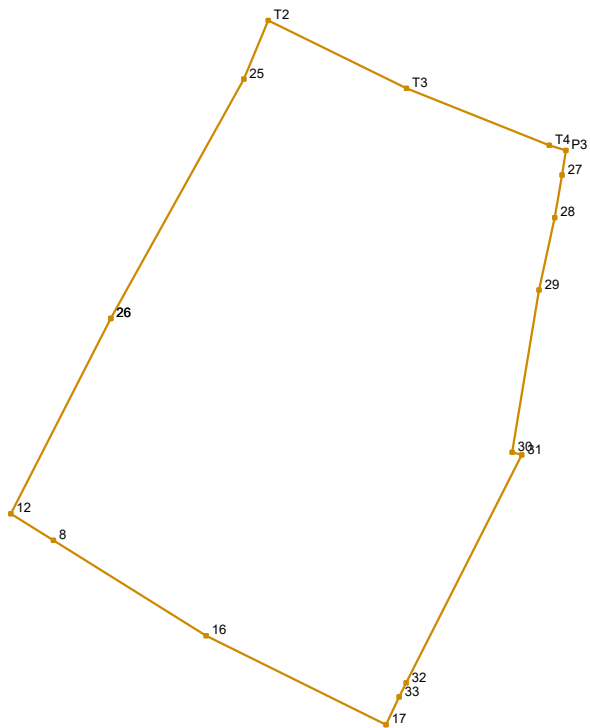

Νέα ιδιοκτησία εντός ΟΤ							
id1:1479		id2:05		Σημεία:17		Εμβαδό:634.49 m <sup>2</sup>	
Σημείο	X	Y	μήκος	Σημείο	X	Y	μήκος
26	499633.433	3928813.444	14.38	30	499654.503	3928806.431	0.51
25	499640.422	3928826.015	3.34	31	499654.998	3928806.293	13.41
T2	499641.697	3928829.105	8.08	32	499648.938	3928794.336	0.82
T3	499648.950	3928825.542	8.08	33	499648.573	3928793.598	1.63
T4	499656.452	3928822.540	0.91	17	499647.878	3928792.128	10.53
P3	499657.322	3928822.267	1.31	16	499638.440	3928796.795	9.46
27	499657.124	3928820.975	2.26	8	499630.416	3928801.803	2.64
28	499656.735	3928818.748	3.88	12	499628.179	3928803.199	11.51
29	499655.904	3928814.955	8.64	26	499633.433	3928813.444	

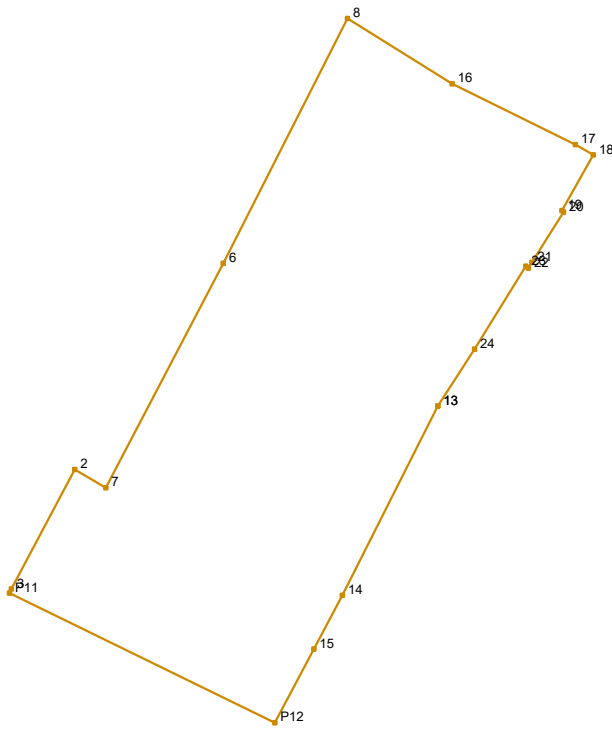

Νέα ιδιοκτησία εντός ΟΤ							
ιδ1:1479		ιδ2:06		Σημεία:19		Εμβαδό:1045.07 m <sup>2</sup>	
Σημείο	X	Y	μήκος	Σημείο	X	Y	μήκος
13	499637.331	3928772.066		16	499638.440	3928796.795	
			16.23				10.53
14	499630.019	3928757.579		17	499647.878	3928792.128	
			4.66				1.59
15	499627.839	3928753.455		18	499649.257	3928791.329	
			6.39				4.90
P12	499624.854	3928747.809		19	499646.854	3928787.059	
			22.65				0.18
P11	499604.502	3928757.742		20	499646.992	3928786.942	
			0.36				4.56
3	499604.665	3928758.057		21	499644.556	3928783.085	
			10.36				0.50
2	499609.511	3928767.214		22	499644.289	3928782.662	
			2.75				0.25
7	499611.882	3928765.828		23	499644.087	3928782.808	
			19.41				7.48
6	499620.888	3928783.022		24	499640.166	3928776.437	
			21.06				5.21
8	499630.416	3928801.803		13	499637.331	3928772.066	
			9.46				



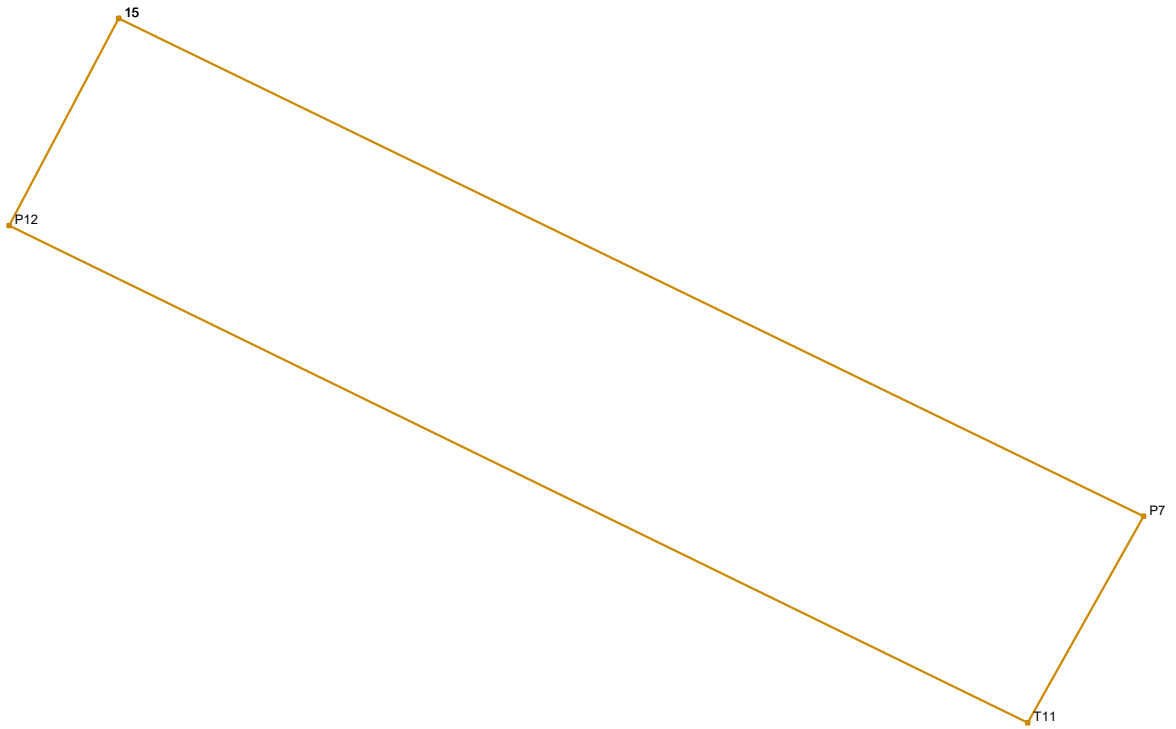

Νέα ιδιοκτησία εντός ΟΤ							
id1:1479		id2:07		Σημεία:4		Εμβαδό:198.62 m <sup>2</sup>	
Σημείο	X	Y	μήκος	Σημείο	X	Y	μήκος
15	499627.839	3928753.455	31.06	P12	499624.854	3928747.809	6.39
P7	499655.776	3928739.885		6.45	15	499627.839	
T11	499652.622	3928734.258	30.90				

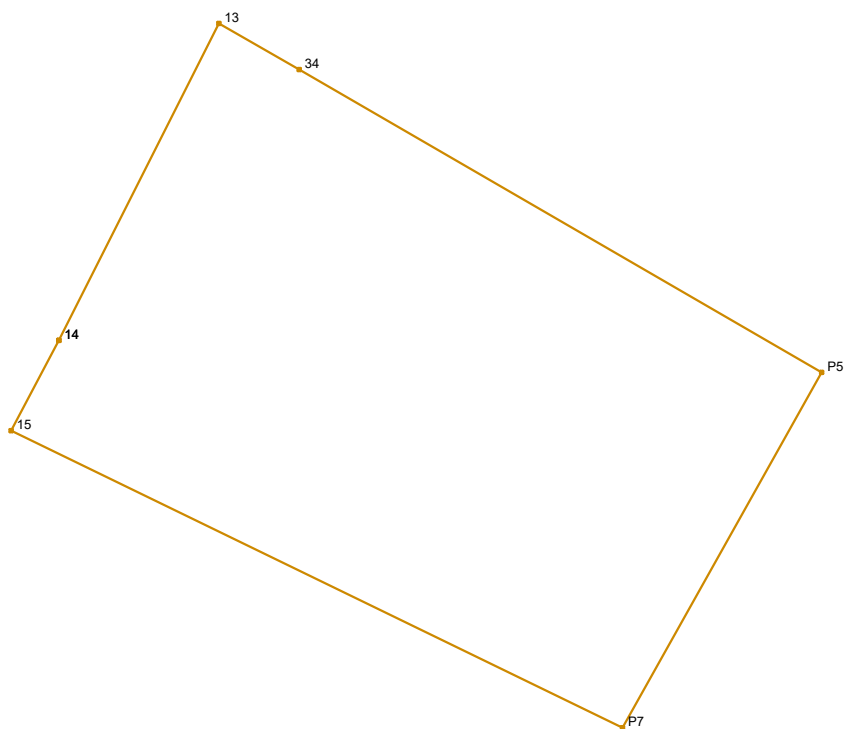

Νέα ιδιοκτησία εντός ΟΤ							
id1:1479		id2:08		Σημεία:6		Εμβαδό:619.94 m <sup>2</sup>	
Σημείο	X	Y	μήκος	Σημείο	X	Y	μήκος
14	499630.019	3928757.579	16.23	P7	499655.776	3928739.885	31.06
13	499637.331	3928772.066		15	499627.839	3928753.455	
34	499641.008	3928769.954	4.24	14	499630.019	3928757.579	4.66
P5	499664.872	3928756.118	27.58				
			18.61				

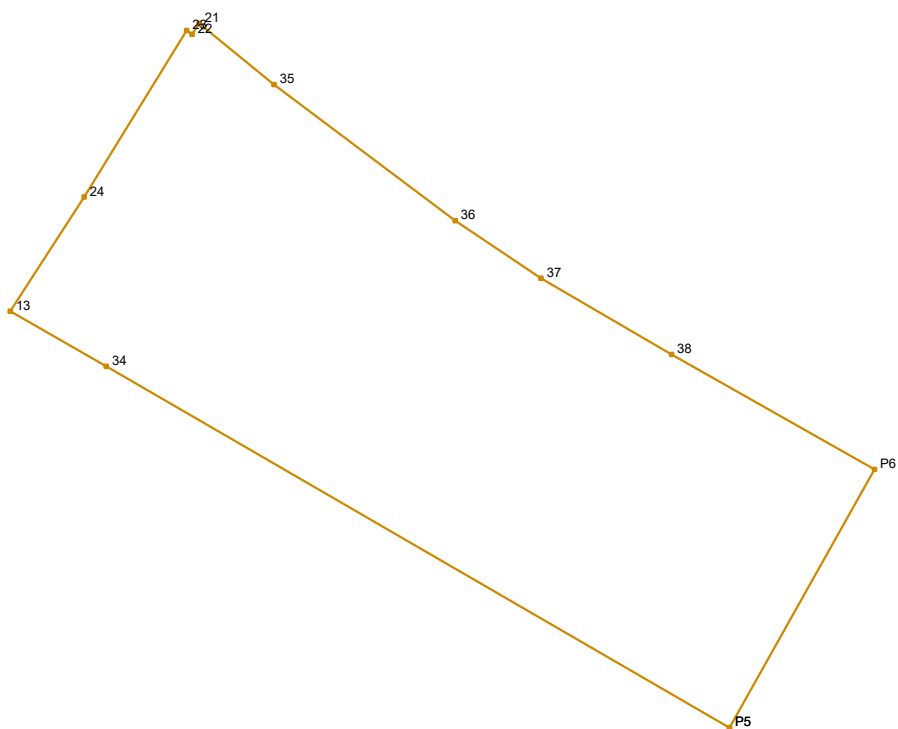

Νέα ιδιοκτησία εντός ΟΤ							
id1:1479		id2:09		Σημεία:12		Εμβαδό:368.38 m <sup>2</sup>	
Σημείο	X	Y	μήκος	Σημείο	X	Y	μήκος
P5	499664.872	3928756.118		35	499647.434	3928780.744	
			27.58				8.68
34	499641.008	3928769.954		36	499654.370	3928775.526	
			4.24				3.95
13	499637.331	3928772.066		37	499657.644	3928773.324	
			5.21				5.79
24	499640.166	3928776.437		38	499662.645	3928770.404	
			7.48				8.93
23	499644.087	3928782.808		P6	499670.414	3928766.009	
			0.25				11.34
22	499644.289	3928782.662		P5	499664.872	3928756.118	
			0.50				
21	499644.556	3928783.085					
			3.71				

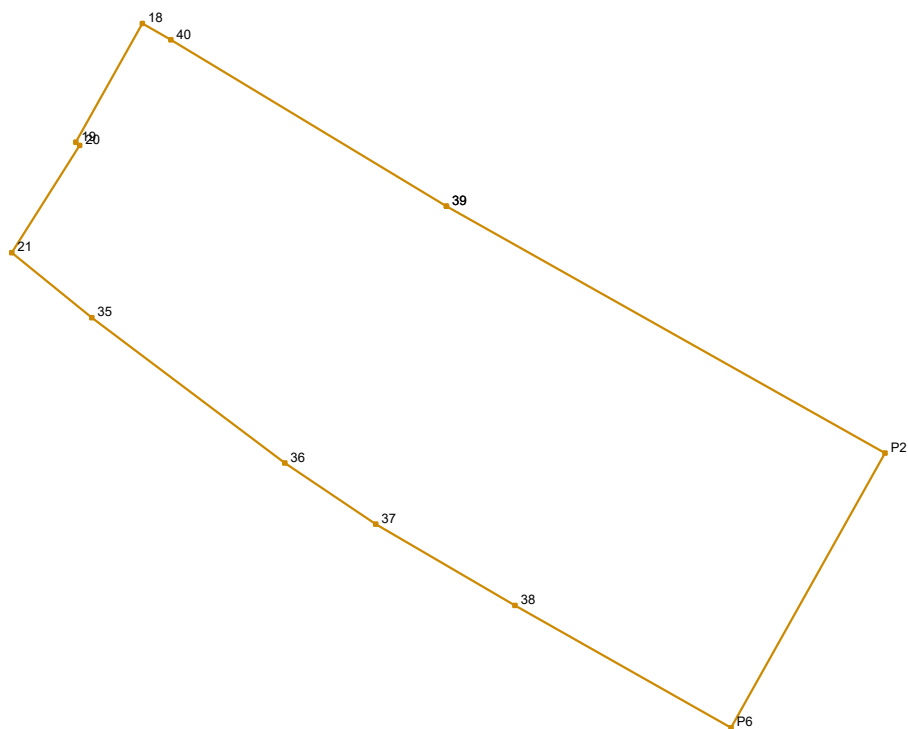

Νέα ιδιοκτησία εντός ΟΤ							
id1:1479		id2:10		Σημεία:12		Εμβαδό:334.38 m <sup>2</sup>	
Σημείο	X	Y	μήκος	Σημείο	X	Y	μήκος
39	499660.189	3928784.751		21	499644.556	3928783.085	
			18.08				4.56
P2	499675.943	3928775.877		20	499646.992	3928786.942	
			11.31				0.18
P6	499670.414	3928766.009		19	499646.854	3928787.059	
			8.93				4.90
38	499662.645	3928770.404		18	499649.257	3928791.329	
			5.79				1.18
37	499657.644	3928773.324		40	499650.281	3928790.736	
			3.95				11.58
36	499654.370	3928775.526		39	499660.189	3928784.751	
			8.68				
35	499647.434	3928780.744					
			3.71				

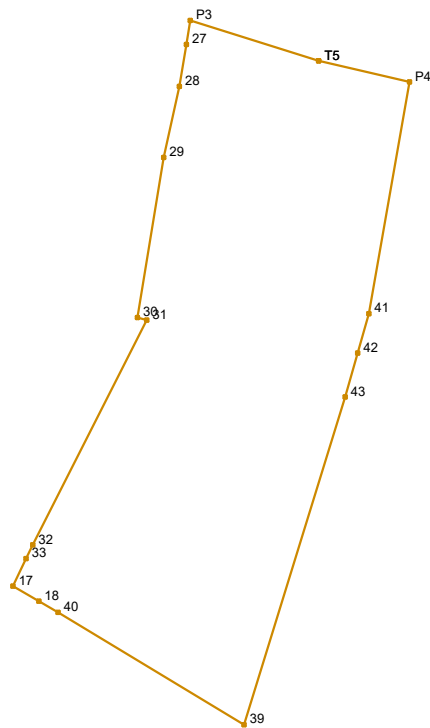

Νέα ιδιοκτησία εντός ΟΤ							
id1:1479		id2:11		Σημεία:17		Εμβαδό:415.94 m <sup>2</sup>	
Σημείο	X	Y	μήκος	Σημείο	X	Y	μήκος
T5	499664.160	3928820.116		33	499648.573	3928793.598	0.82
P4	499669.007	3928818.988	4.98	32	499648.938	3928794.336	13.41
41	499666.830	3928806.635	12.54	31	499654.998	3928806.293	0.51
42	499666.239	3928804.541	2.18	30	499654.503	3928806.431	8.64
43	499665.574	3928802.216	2.42	29	499655.904	3928814.955	3.88
39	499660.189	3928784.751	18.28	28	499656.735	3928818.748	2.26
40	499650.281	3928790.736	11.58	27	499657.124	3928820.975	1.31
18	499649.257	3928791.329	1.18	P3	499657.322	3928822.267	7.17
17	499647.878	3928792.128	1.59	T5	499664.160	3928820.116	
			1.63				

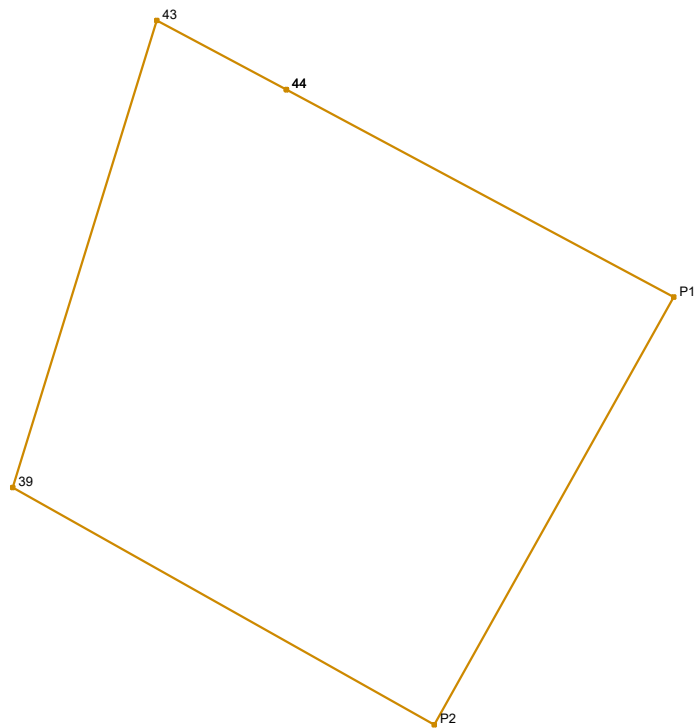

Νέα ιδιοκτησία εντός ΟΤ							
id1:1479		id2:12		Σημεία:5		Εμβαδό:362.32 m <sup>2</sup>	
Σημείο	X	Y	μήκος	Σημείο	X	Y	μήκος
44	499670.416	3928799.622	16.43	39	499660.189	3928784.751	18.28
P1	499684.901	3928791.863		43	499665.574	3928802.216	
P2	499675.943	3928775.877	18.32	44	499670.416	3928799.622	18.08

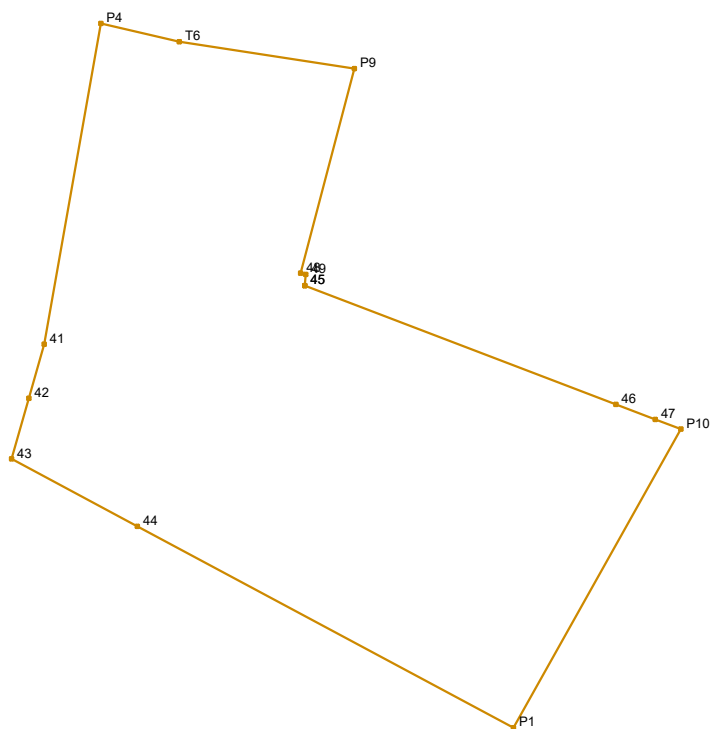

Νέα ιδιοκτησία εντός ΟΤ							
id1:1479		id2:13		Σημεία:14		Εμβαδό:344.78 m <sup>2</sup>	
Σημείο	X	Y	μήκος	Σημείο	X	Y	μήκος
45	499676.860	3928808.884	12.82	41	499666.830	3928806.635	12.54
46	499688.840	3928804.316		P4	499669.007	3928818.988	3.10
47	499690.361	3928803.736	1.63	T6	499672.030	3928818.284	6.82
P10	499691.344	3928803.361	1.05	P9	499678.767	3928817.247	8.15
P1	499684.901	3928791.863	13.18	48	499676.704	3928809.362	0.20
44	499670.416	3928799.622	16.43	49	499676.897	3928809.312	0.43
43	499665.574	3928802.216	5.49	45	499676.860	3928808.884	
42	499666.239	3928804.541	2.42				
			2.18				

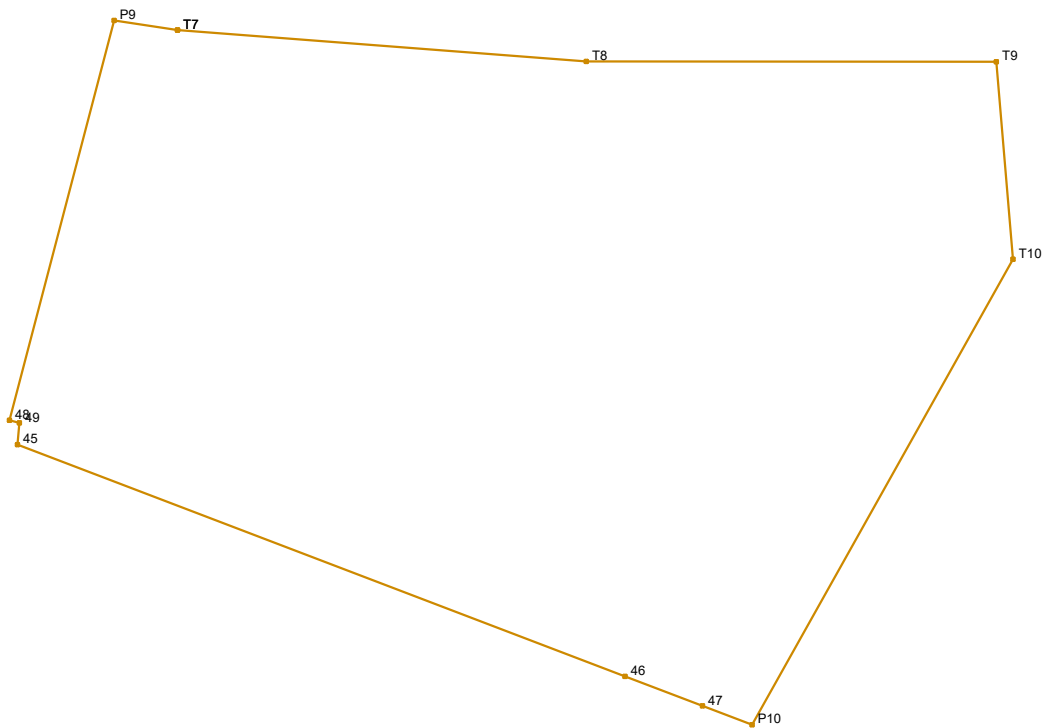

Νέα ιδιοκτησία εντός ΟΤ							
id1:1479		id2:14		Σημεία:11		Εμβαδό:190.34 m <sup>2</sup>	
Σημείο	X	Y	μήκος	Σημείο	X	Y	μήκος
T7	499680.017	3928817.054	8.08	46	499688.840	3928804.316	12.82
T8	499688.073	3928816.434		45	499676.860	3928808.884	0.43
T9	499696.154	3928816.427	3.90	49	499676.897	3928809.312	0.20
T10	499696.487	3928812.538		48	499676.704	3928809.362	8.15
P10	499691.344	3928803.361	10.52	P9	499678.767	3928817.247	1.26
47	499690.361	3928803.736	1.05	T7	499680.017	3928817.054	
			1.63				



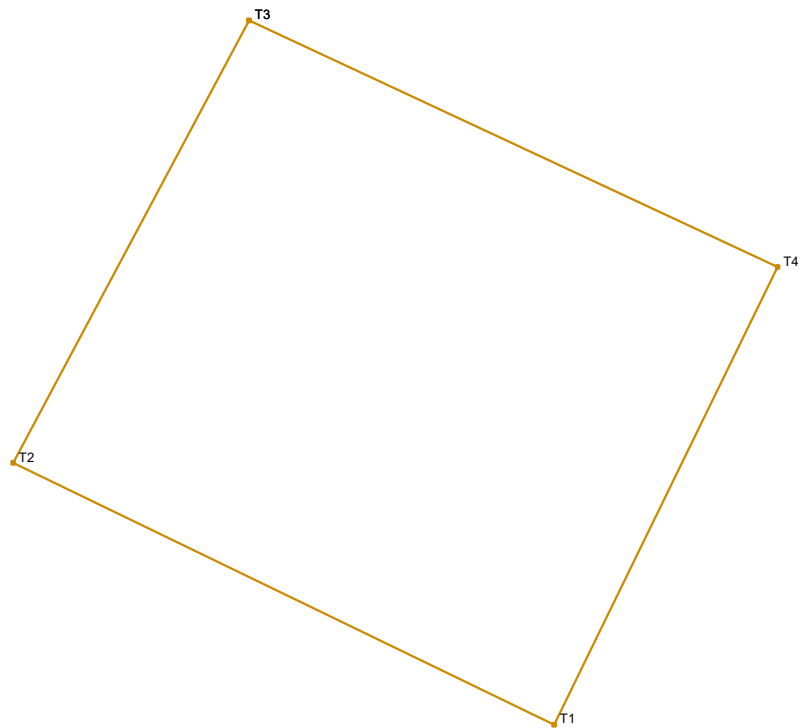

Νέα ιδιοκτησία εντός ΟΤ							
id1:1482		id2:01		Σημεία:4		Εμβαδό:1274.23 m <sup>2</sup>	
Σημείο	X	Y	μήκος	Σημείο	X	Y	μήκος
T3	499501.844	3928844.241	38.05	T2	499486.435	3928815.350	32.74
T4	499536.328	3928828.152		33.25	T3	499501.844	
T1	499521.754	3928798.270	39.23				

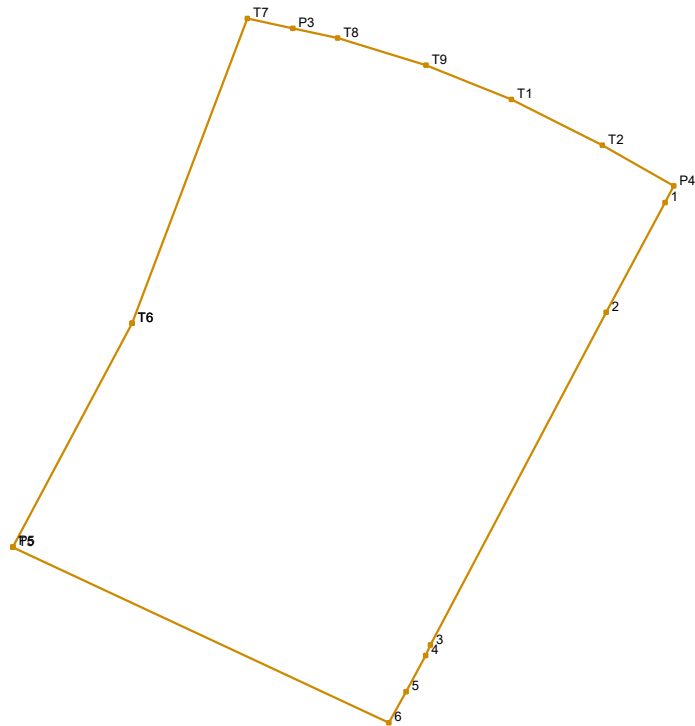

Νέα ιδιοκτησία εντός ΟΤ							
id1:1483		id2:01		Σημεία:16		Εμβαδό:1559.61 m <sup>2</sup>	
Σημείο	X	Y	μήκος	Σημείο	X	Y	μήκος
T6	499513.928	3928866.899	25.27	2	499550.679	3928867.754	29.17
T7	499522.855	3928890.545		3.62	3	499537.064	3928841.955
P3	499526.389	3928889.768	3.54	4	499536.691	3928841.142	3.18
T8	499529.850	3928889.006	7.16	5	499535.162	3928838.352	2.76
T9	499536.695	3928886.900	7.14	6	499533.838	3928835.934	32.18
T1	499543.321	3928884.250	7.89	T5	499504.672	3928849.543	0.05
T2	499550.370	3928880.696	6.38	P5	499504.695	3928849.586	19.62
P4	499555.923	3928877.559	1.46	T6	499513.928	3928866.899	
1	499555.234	3928876.271	9.66				

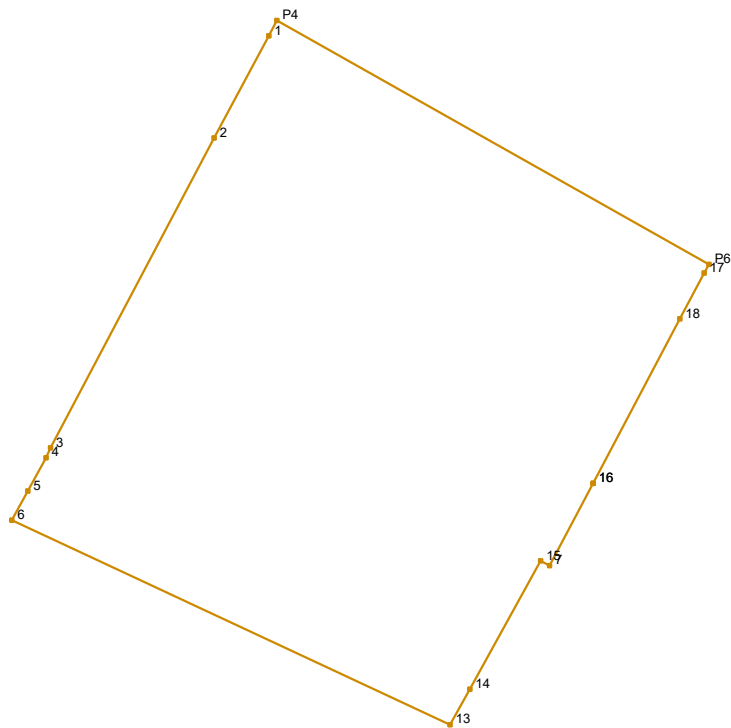

Νέα ιδιοκτησία εντός ΟΤ							
id1:1483		id2:02		Σημεία:15		Εμβαδό:1865.37 m <sup>2</sup>	
Σημείο	X	Y	μήκος	Σημείο	X	Y	μήκος
16	499582.244	3928838.998	7.75	3	499537.064	3928841.955	29.17
7	499578.622	3928832.151	0.85	2	499550.679	3928867.754	9.66
15	499577.872	3928832.553	12.21	1	499555.234	3928876.271	1.46
14	499571.975	3928821.866	3.38	P4	499555.923	3928877.559	41.31
13	499570.340	3928818.904	40.28	P6	499591.888	3928857.242	0.83
6	499533.838	3928835.934	2.76	17	499591.498	3928856.509	4.32
5	499535.162	3928838.352	3.18	18	499589.468	3928852.699	15.49
4	499536.691	3928841.142	0.89	16	499582.244	3928838.998	

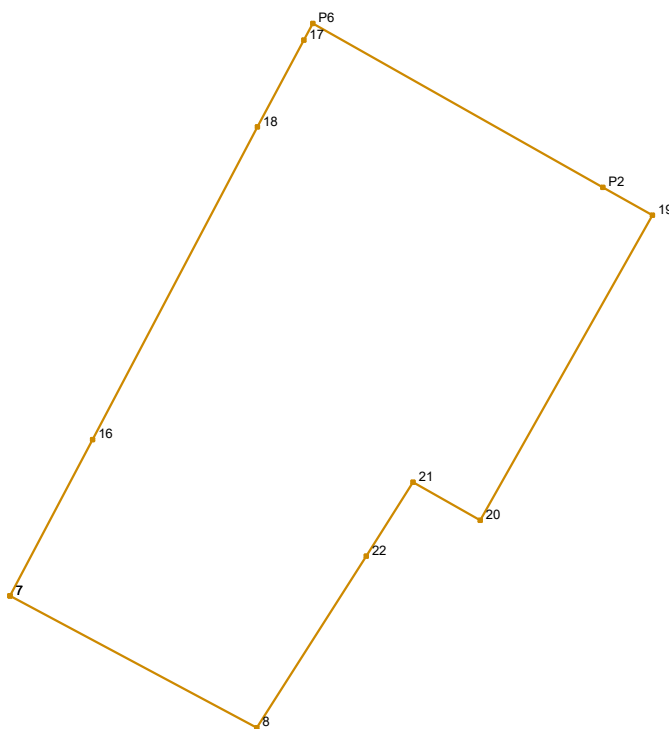

Νέα ιδιοκτησία εντός ΟΤ							
id1:1483		id2:03		Σημεία:11		Εμβαδό:424.22 m <sup>2</sup>	
Σημείο	X	Y	μήκος	Σημείο	X	Y	μήκος
7	499578.622	3928832.151	7.75	19	499606.789	3928848.825	15.35
16	499582.244	3928838.998	15.49	20	499599.239	3928835.460	3.39
18	499589.468	3928852.699	4.32	21	499596.289	3928837.126	3.84
17	499591.498	3928856.509	0.83	22	499594.234	3928833.880	8.91
P6	499591.888	3928857.242	14.61	8	499589.442	3928826.364	12.27
P2	499604.612	3928850.054	2.50	7	499578.622	3928832.151	

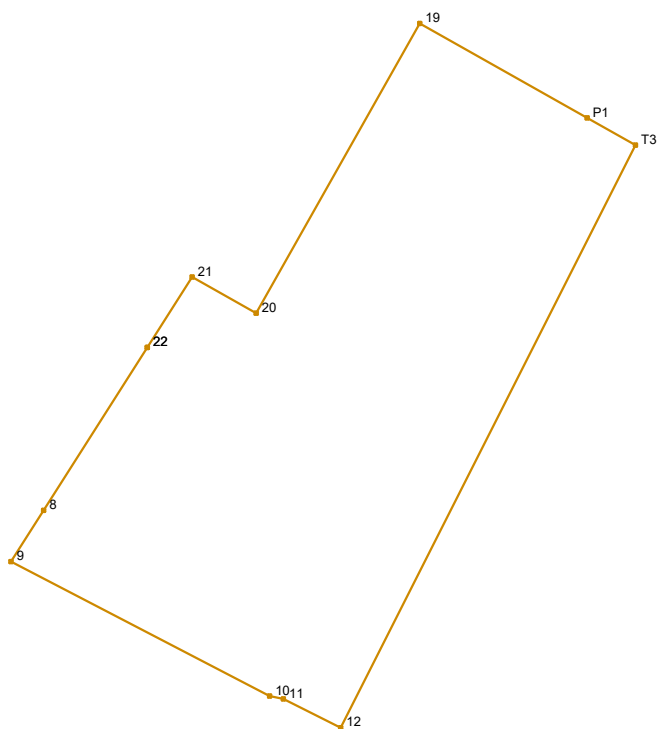

Νέα ιδιοκτησία εντός ΟΤ							
id1:1483		id2:04		Σημεία:11		Εμβαδό:427.92 m <sup>2</sup>	
Σημείο	X	Y	μήκος	Σημείο	X	Y	μήκος
22	499594.234	3928833.880	3.84	12	499603.142	3928816.342	2.95
21	499596.289	3928837.126		0.65			
20	499599.239	3928835.460	15.35	10	499599.869	3928817.806	13.44
19	499606.789	3928848.825		2.79			
P1	499614.509	3928844.463	2.57	8	499589.442	3928826.364	8.91
T3	499616.743	3928843.202		30.11	22	499594.234	

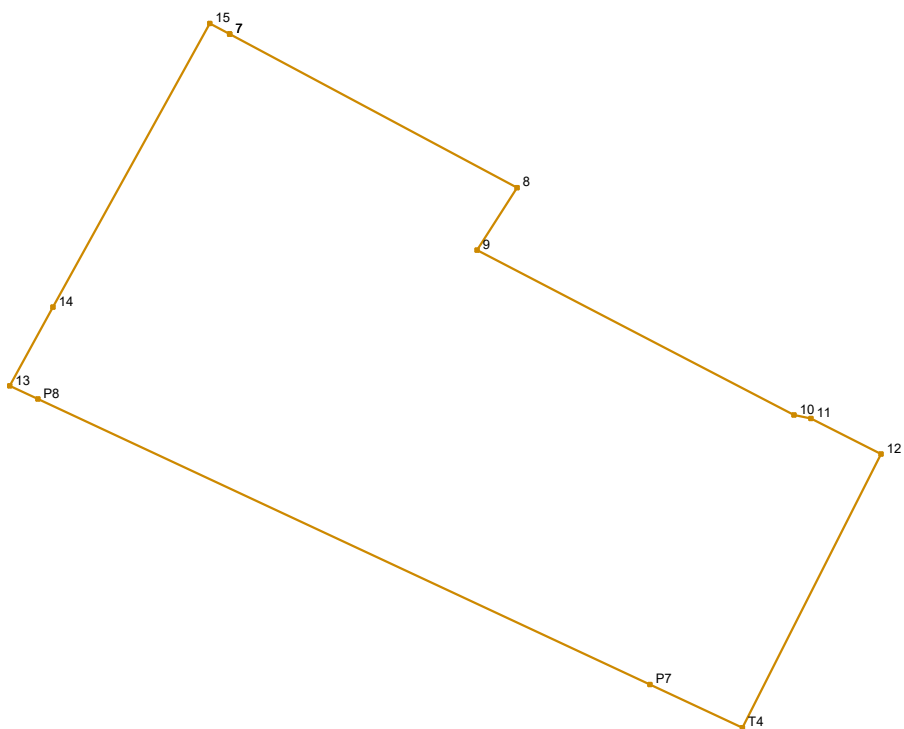

Νέα ιδιοκτησία εντός ΟΤ							
id1:1483		id2:05		Σημεία:12		Εμβαδό:400.00 m <sup>2</sup>	
Σημείο	X	Y	μήκος	Σημείο	X	Y	μήκος
7	499578.622	3928832.151	12.27	P7	499594.446	3928807.657	25.43
8	499589.442	3928826.364		2.79	P8	499571.403	
9	499587.941	3928824.009	13.44		13	499570.340	3928818.904
10	499599.869	3928817.806		0.65	14	499571.975	3928821.866
11	499600.506	3928817.677	2.95		15	499577.872	3928832.553
12	499603.142	3928816.342		11.55	7	499578.622	3928832.151
T4	499597.923	3928806.035	3.84				

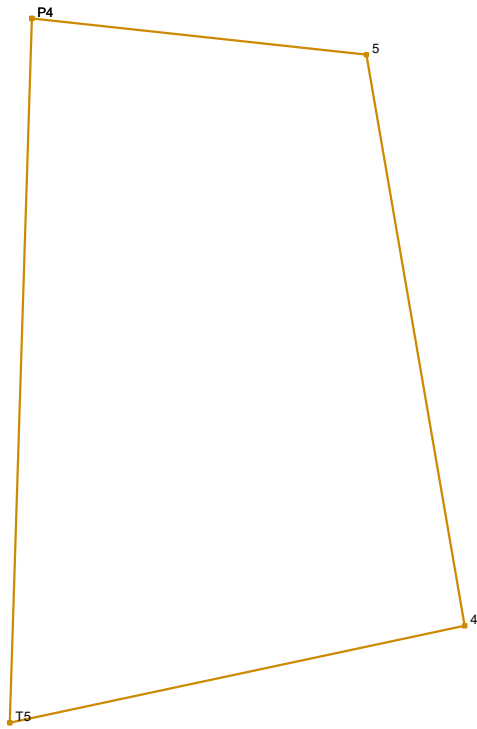

Νέα ιδιοκτησία εντός ΟΤ							
id1:1484		id2:01		Σημεία:4		Εμβαδό:745.36 m <sup>2</sup>	
Σημείο	X	Y	μήκος	Σημείο	X	Y	μήκος
P4	499363.903	3928669.977	18.26	T5	499362.707	3928631.725	38.27
5	499382.057	3928668.007		31.47	P4	499363.903	
4	499387.401	3928636.999	25.25				

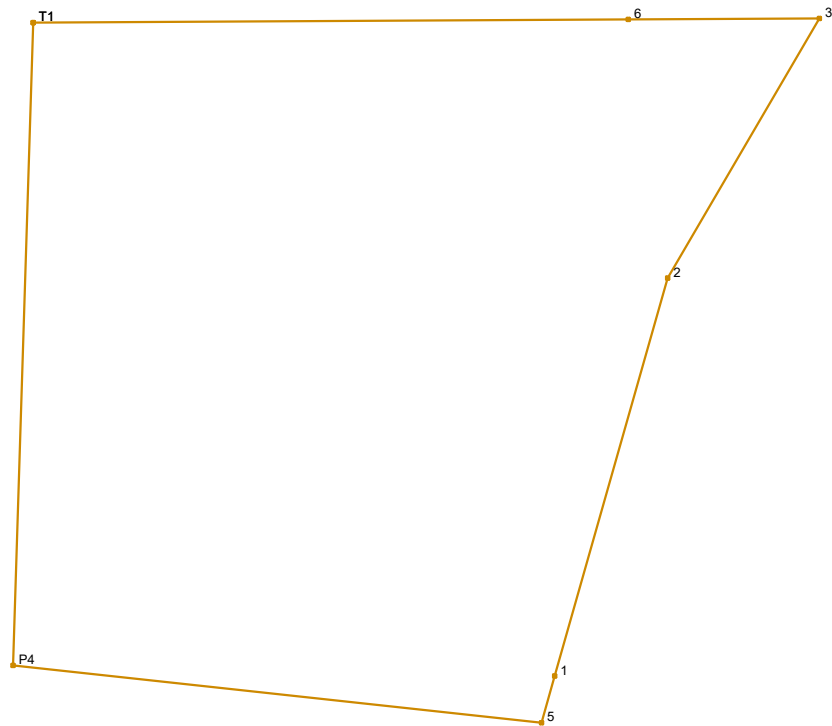

Νέα ιδιοκτησία εντός ΟΤ							
id1:1484		id2:02N		Σημεία:7		Εμβαδό:507.00 m <sup>2</sup>	
Σημείο	X	Y	μήκος	Σημείο	X	Y	μήκος
T1	499364.593	3928692.067	20.44	1	499382.514	3928669.615	1.67
6	499385.036	3928692.179		5	499382.057	3928668.007	18.26
3	499391.609	3928692.215	6.57	P4	499363.903	3928669.977	22.10
2	499386.394	3928683.289	10.34	T1	499364.593	3928692.067	
			14.21				



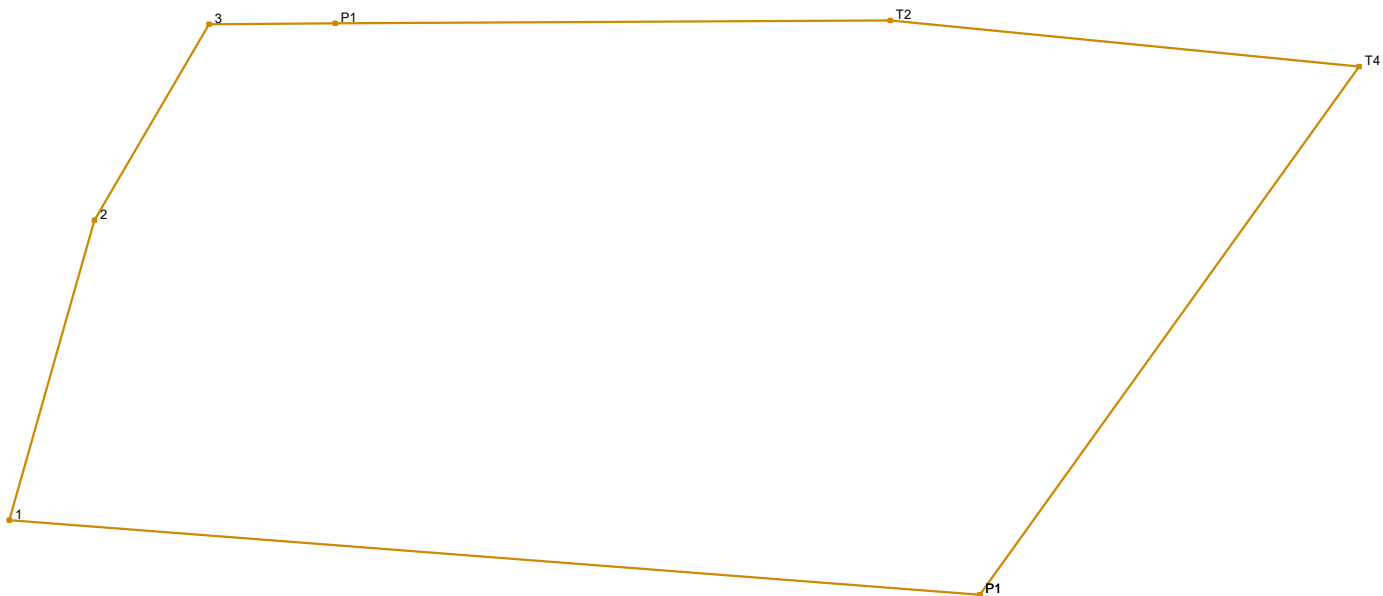

Νέα ιδιοκτησία εντός ΟΤ							
id1:1484		id2:03		Σημεία:7		Εμβαδό:1215.41 m <sup>2</sup>	
Σημείο	X	Y	μήκος	Σημείο	X	Y	μήκος
P1	499426.741	3928666.221		P1	499397.357	3928692.247	
			44.36	T2	499422.650	3928692.386	25.29
1	499382.514	3928669.615					
			14.21	T4	499444.034	3928690.277	21.49
2	499386.394	3928683.289					
			10.34	P1	499426.741	3928666.221	29.63
3	499391.609	3928692.215					
			5.75				

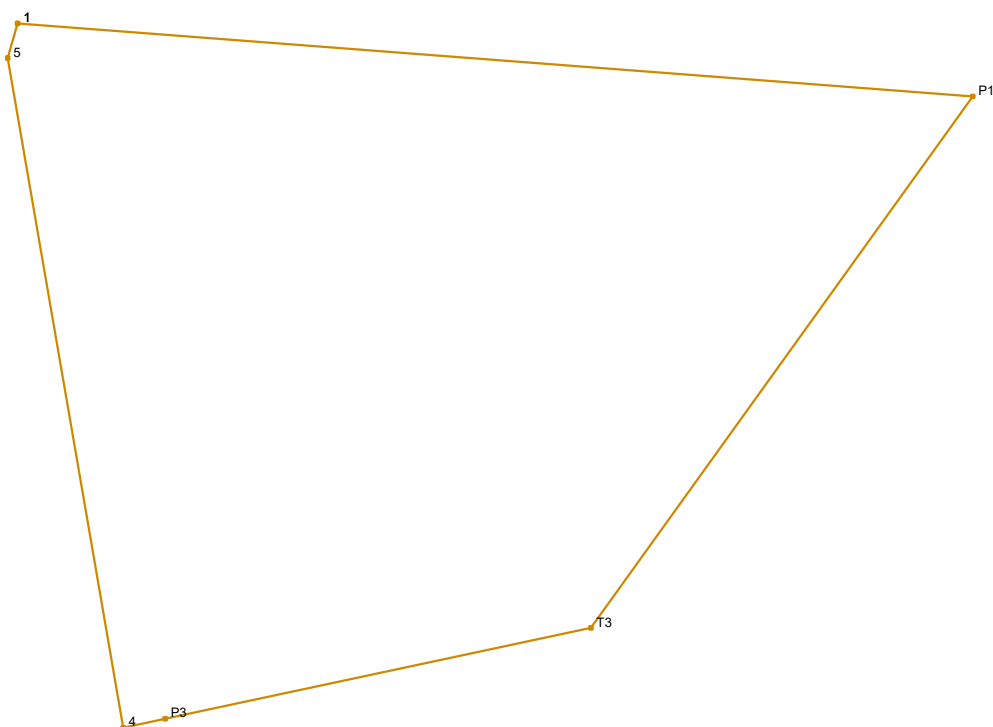

Νέα ιδιοκτησία εντός ΟΤ							
id1:1484		id2:04		Σημεία:6		Εμβαδό:949.82 m <sup>2</sup>	
Σημείο	X	Y	μήκος	Σημείο	X	Y	μήκος
1	499382.514	3928669.615	44.36	4	499387.401	3928636.999	31.47
P1	499426.741	3928666.221		30.29	5	499382.057	
T3	499409.059	3928641.624	20.16	1	499382.514	3928669.615	
P3	499389.343	3928637.413	1.99				

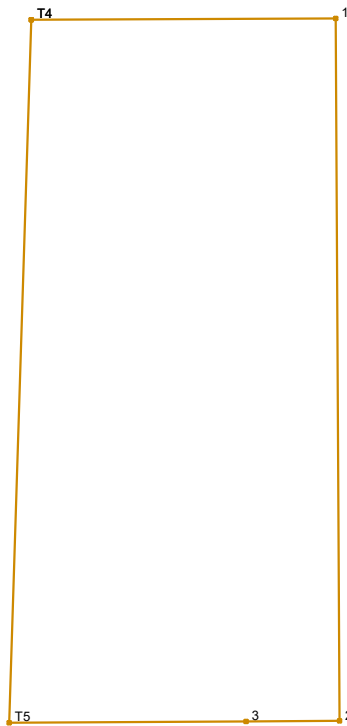

Νέα ιδιοκτησία εντός ΟΤ							
id1:1485		id2:01		Σημεία:5		Εμβαδό:500.00 m <sup>2</sup>	
Σημείο	X	Y	μήκος	Σημείο	X	Y	μήκος
T4	499375.953	3928735.400	14.42	3	499386.134	3928702.185	11.22
1	499390.378	3928735.471	33.26	T5	499374.913	3928702.124	33.29
2	499390.548	3928702.210	4.41	T4	499375.953	3928735.400	

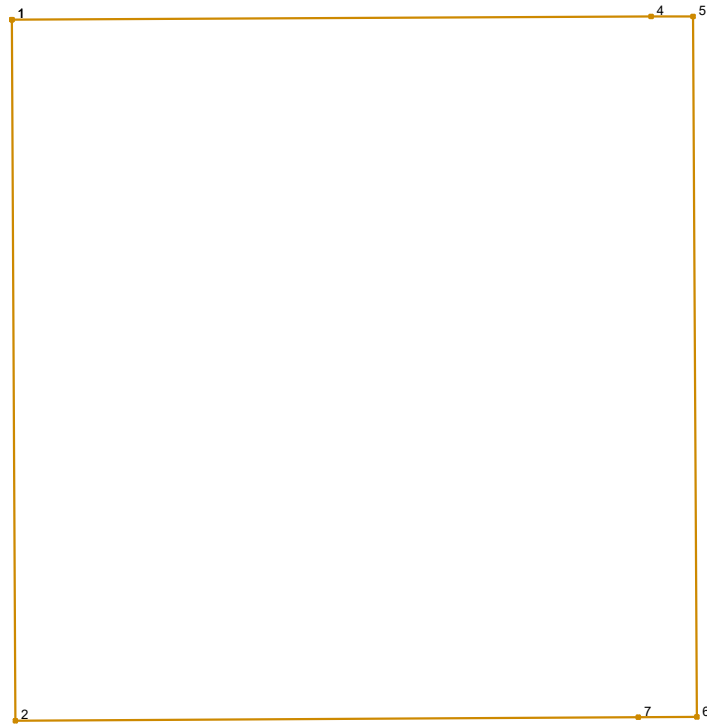

Νέα ιδιοκτησία εντός ΟΤ							
id1:1485		id2:02		Σημεία:6		Εμβαδό:1075.08 m <sup>2</sup>	
Σημείο	X	Y	μήκος	Σημείο	X	Y	μήκος
1	499390.378	3928735.471		7	499420.102	3928702.372	
			30.34				29.55
4	499420.717	3928735.621		2	499390.548	3928702.210	
			1.98				33.26
5	499422.701	3928735.631		1	499390.378	3928735.471	
			33.24				
6	499422.884	3928702.387					
			2.78				

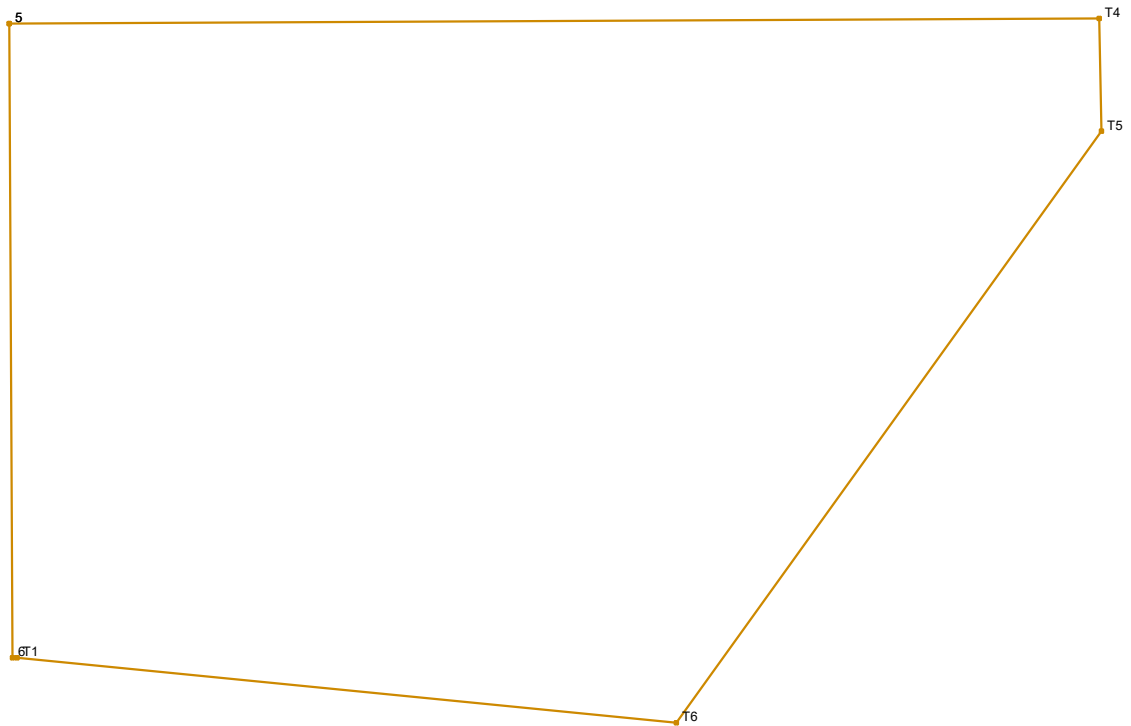

Νέα ιδιοκτησία εντός ΟΤ							
id1:1485		id2:03		Σημεία:6		Εμβαδό:1697.76 m <sup>2</sup>	
Σημείο	X	Y	μήκος	Σημείο	X	Y	μήκος
5	499422.701	3928735.631	57.15	T1	499423.114	3928702.388	0.23
T4	499479.851	3928735.913		5.92	6	499422.884	3928702.387
T5	499479.975	3928729.995	38.20	5	499422.701	3928735.631	
T6	499457.680	3928698.980	34.73				

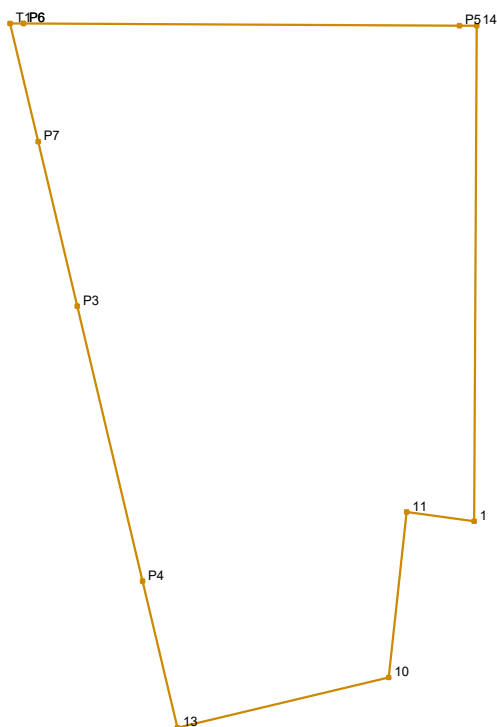

Νέα ιδιοκτησία εντός ΟΤ							
id1:1486		id2:01N		Σημεία:11		Εμβαδό:990.08 m <sup>2</sup>	
Σημείο	X	Y	μήκος	Σημείο	X	Y	μήκος
P6	499298.568	3928733.398	27.65	13	499308.340	3928688.719	9.56
P5	499326.217	3928733.253	1.10	P4	499306.129	3928698.016	17.94
14	499327.316	3928733.247	31.44	P3	499301.978	3928715.467	10.73
1	499327.152	3928701.813	4.32	P7	499299.495	3928725.906	7.71
11	499322.870	3928702.398	10.55	T1	499297.712	3928733.403	0.86
10	499321.732	3928691.905	13.77	P6	499298.568	3928733.398	

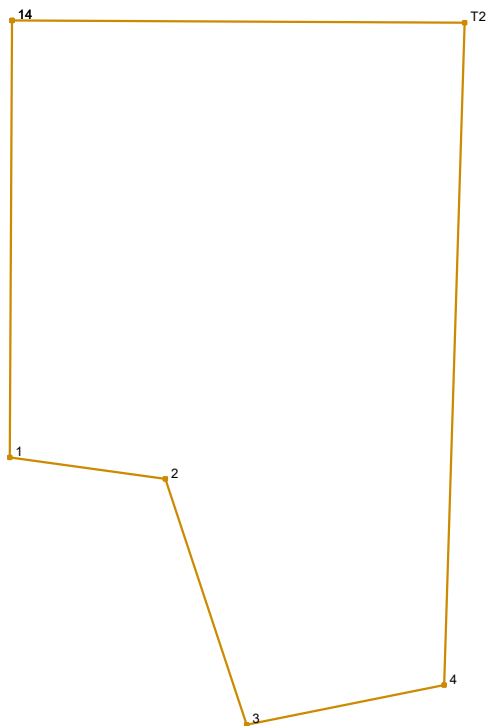

Νέα ιδιοκτησία εντός ΟΤ							
id1:1486		id2:02		Σημεία:6		Εμβαδό:1333.95 m <sup>2</sup>	
Σημείο	X	Y	μήκος	Σημείο	X	Y	μήκος
14	499327.316	3928733.247	32.56	2	499338.337	3928700.283	11.29
T2	499359.873	3928733.077		47.66	1	499327.152	3928701.813
4	499358.383	3928685.441	14.47	14	499327.316	3928733.247	
3	499344.194	3928682.592	18.64				

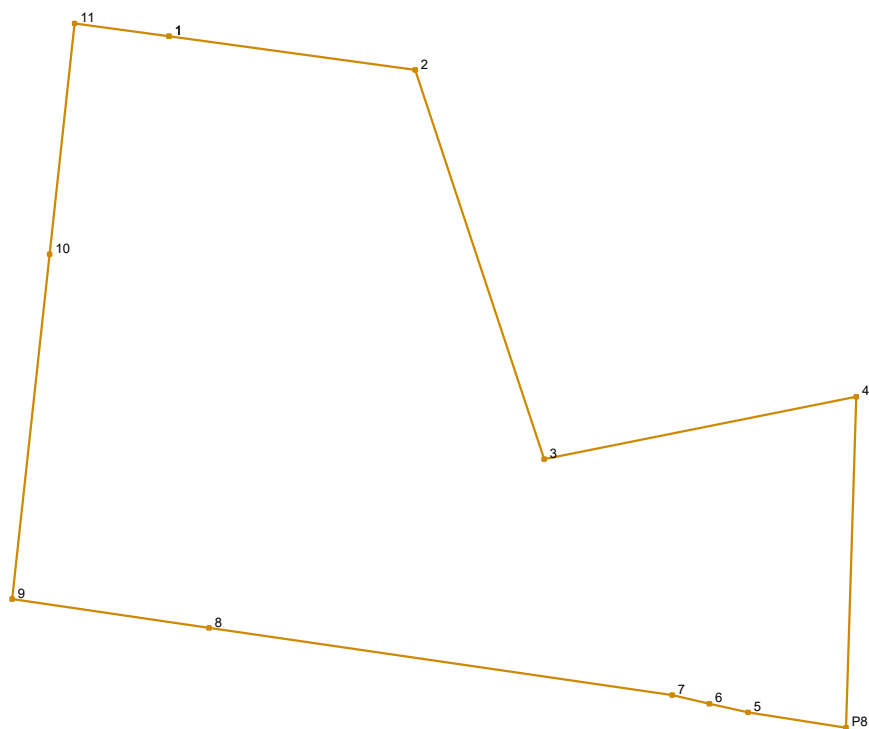

Νέα ιδιοκτησία εντός ΟΤ							
id1:1486		id2:03		Σημεία:12		Εμβαδό:730.09 m <sup>2</sup>	
Σημείο	X	Y	μήκος	Σημείο	X	Y	μήκος
1	499327.152	3928701.813	11.29	7	499350.020	3928671.875	21.27
2	499338.337	3928700.283	18.64	8	499328.968	3928674.942	9.03
3	499344.194	3928682.592	14.47	9	499320.033	3928676.244	15.75
4	499358.383	3928685.441	15.05	10	499321.732	3928691.905	10.55
P8	499357.913	3928670.398	4.50	11	499322.870	3928702.398	4.32
5	499353.469	3928671.100	1.80	1	499327.152	3928701.813	
6	499351.710	3928671.495	1.73				



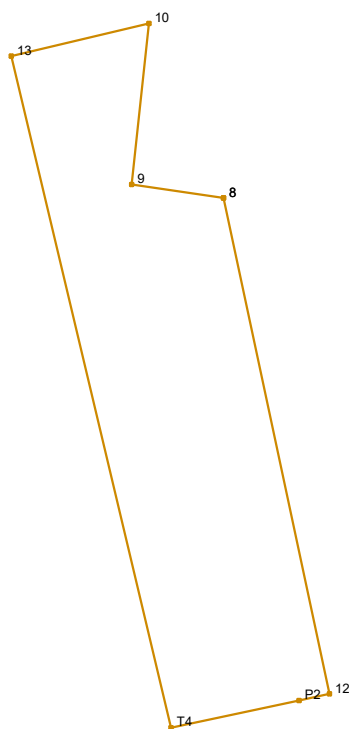

Νέα ιδιοκτησία εντός ΟΤ							
id1:1486		id2:04		Σημεία:7		Εμβαδό:1008.65 m <sup>2</sup>	
Σημείο	X	Y	μήκος	Σημείο	X	Y	μήκος
8	499328.968	3928674.942	49.31	13	499308.340	3928688.719	13.77
12	499339.268	3928626.719		3.01	10	499321.732	3928691.905
P2	499336.322	3928626.089	12.73	9	499320.033	3928676.244	9.03
T4	499323.870	3928623.430	67.11	8	499328.968	3928674.942	

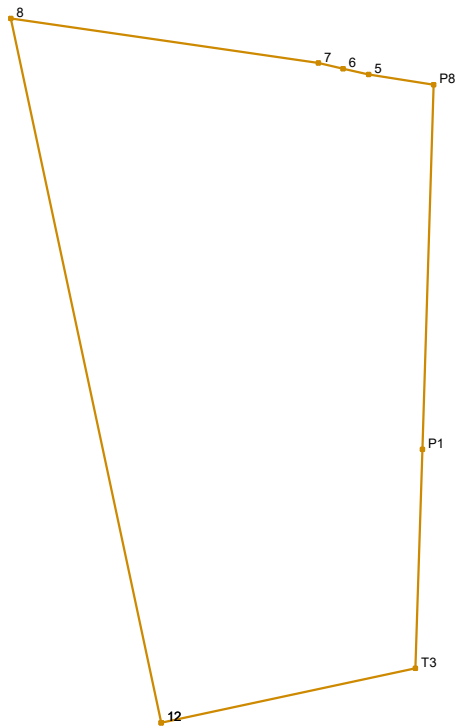

Νέα ιδιοκτησία εντός ΟΤ							
id1:1486		id2:05		Σημεία:8		Εμβαδό:1022.71 m <sup>2</sup>	
Σημείο	X	Y	μήκος	Σημείο	X	Y	μήκος
12	499339.268	3928626.719	49.31	P8	499357.913	3928670.398	24.98
8	499328.968	3928674.942	21.27	P1	499357.132	3928645.435	15.01
7	499350.020	3928671.875	1.73	T3	499356.663	3928630.434	17.79
6	499351.710	3928671.495	1.80	12	499339.268	3928626.719	
5	499353.469	3928671.100	4.50				

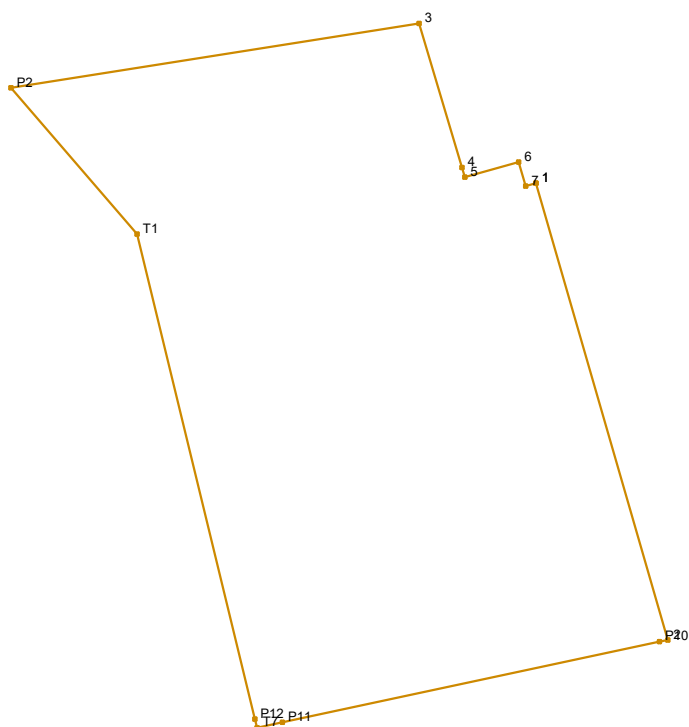

Νέα ιδιοκτησία εντός ΟΤ							
id1:1487		id2:01		Σημεία:13		Εμβαδό:641.08 m <sup>2</sup>	
Σημείο	X	Y	μήκος	Σημείο	X	Y	μήκος
1	499297.994	3928641.753	23.38	P2	499272.177	3928646.447	20.32
2	499304.480	3928619.289		0.41	3	499292.250	3928649.621
P10	499304.081	3928619.204	18.97	4	499294.367	3928642.522	0.49
P11	499285.529	3928615.241	1.27	5	499294.507	3928642.051	2.75
T7	499284.282	3928614.975	0.44	6	499297.154	3928642.798	1.23
P12	499284.180	3928615.399	24.55	7	499297.502	3928641.614	0.51
T1	499278.388	3928639.258	9.50	1	499297.994	3928641.753	

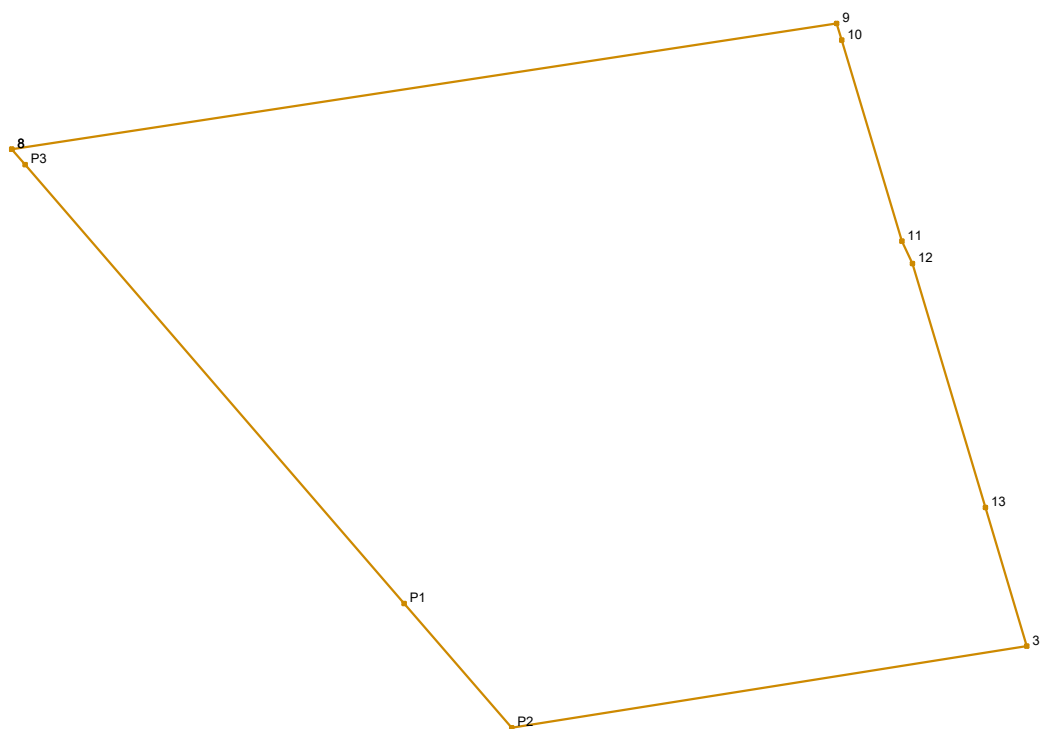

Νέα ιδιοκτησία εντός ΟΤ							
ιδ1:1487		ιδ2:02N		Σημεία:10		Εμβαδό:665.88 m <sup>2</sup>	
Σημείο	X	Y	μήκος	Σημείο	X	Y	μήκος
8	499252.704	3928668.984	32.51	3	499292.250	3928649.621	20.32
9	499284.842	3928673.893	0.69	P2	499272.177	3928646.447	6.40
10	499285.038	3928673.236	8.17	P1	499267.996	3928651.286	22.60
11	499287.379	3928665.404	0.96	P3	499253.218	3928668.389	0.79
12	499287.802	3928664.537	9.93	8	499252.704	3928668.984	
13	499290.638	3928655.026	5.64				

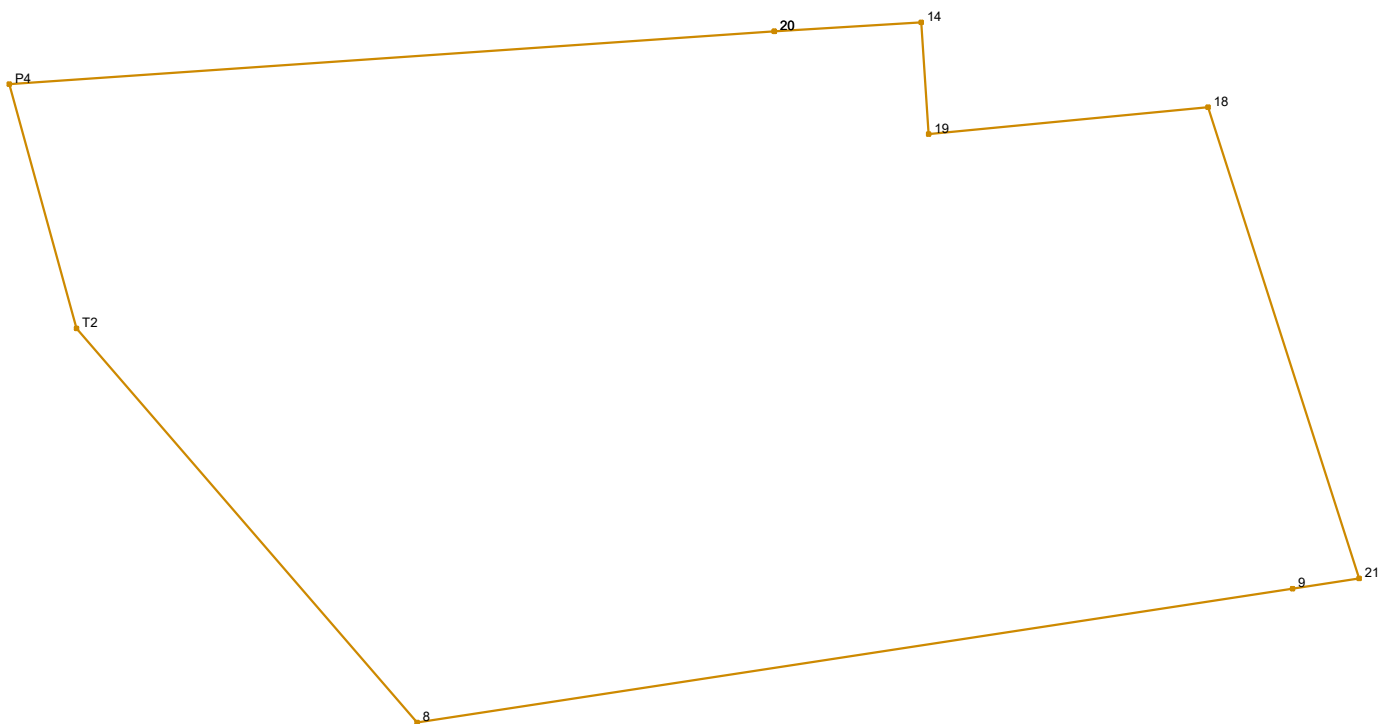

Νέα ιδιοκτησία εντός ΟΤ							
id1:1487		id2:03		Σημεία:9		Εμβαδό:905.01 m <sup>2</sup>	
Σημείο	X	Y	μήκος	Σημείο	X	Y	μήκος
20	499265.820	3928694.356	5.40	9	499284.842	3928673.893	32.51
14	499271.205	3928694.683	4.11	8	499252.704	3928668.984	19.13
19	499271.486	3928690.587	10.30	T2	499240.198	3928683.458	9.29
18	499281.742	3928691.577	18.18	P4	499237.726	3928692.416	28.16
21	499287.294	3928674.268	2.48	20	499265.820	3928694.356	

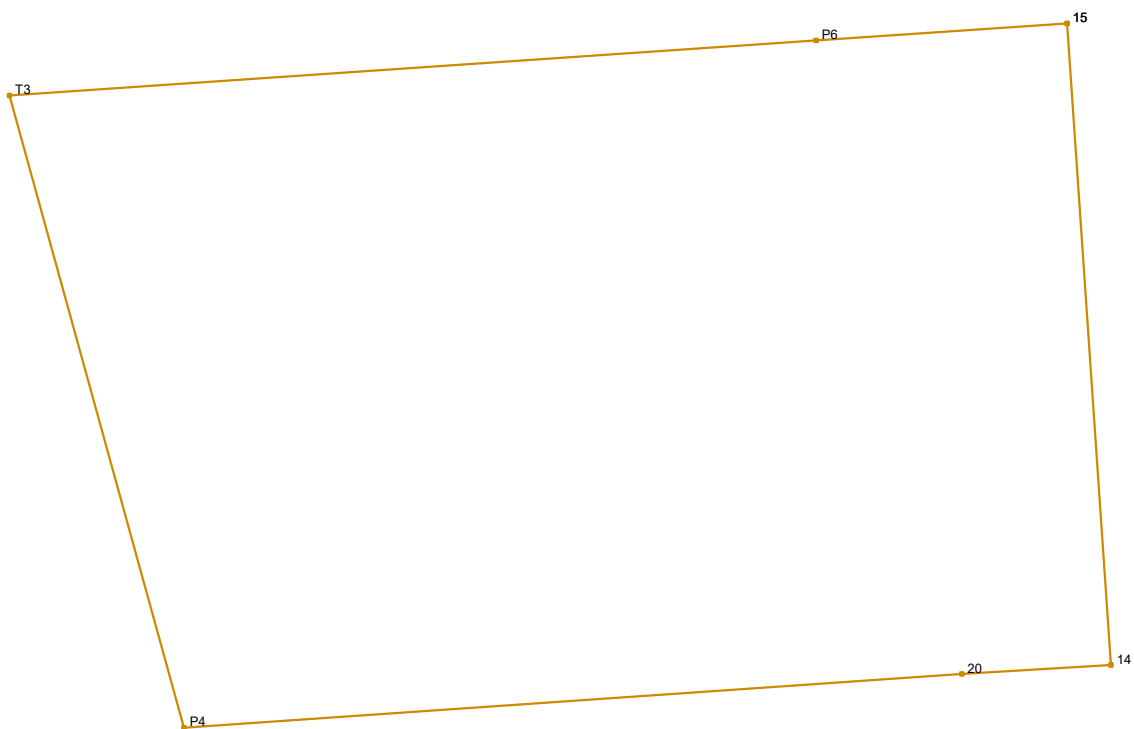

Νέα ιδιοκτησία εντός ΟΤ							
id1:1487		id2:04		Σημεία:6		Εμβαδό:833.15 m <sup>2</sup>	
Σημείο	X	Y	μήκος	Σημείο	X	Y	μήκος
15	499269.621	3928717.853	23.22	T3	499231.427	3928715.241	29.19
14	499271.205	3928694.683		5.40	P6	499260.551	3928717.233
20	499265.820	3928694.356	28.16		15	499269.621	3928717.853
P4	499237.726	3928692.416		23.68			

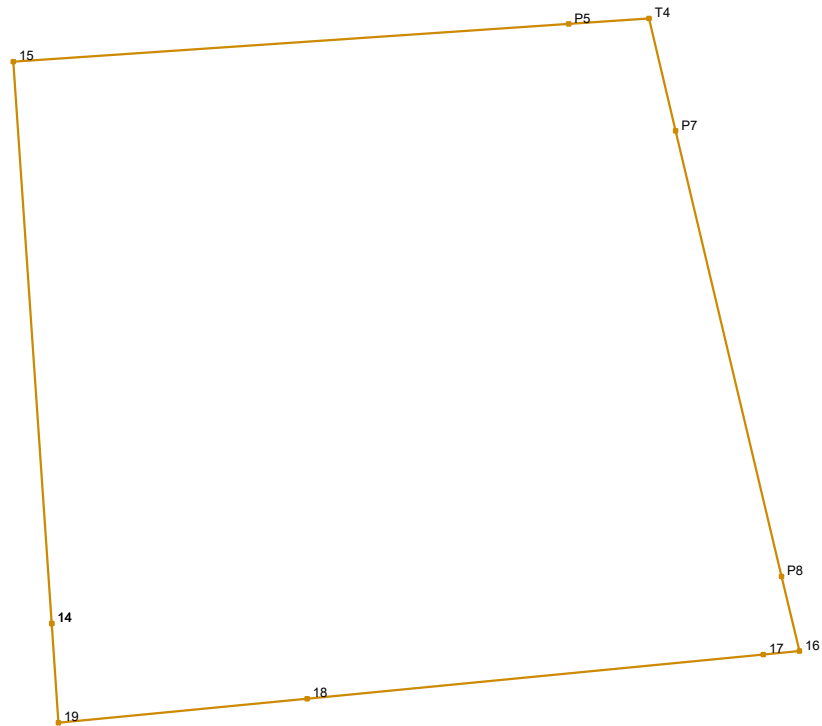

Νέα ιδιοκτησία εντός ΟΤ							
id1:1487		id2:05		Σημεία:10		Εμβαδό:767.38 m <sup>2</sup>	
Σημείο	X	Y	μήκος	Σημείο	X	Y	μήκος
14	499271.205	3928694.683	23.22	16	499302.054	3928693.539	1.50
15	499269.621	3928717.853		17	499300.562	3928693.395	18.91
P5	499292.542	3928719.421	3.31	18	499281.742	3928691.577	10.30
T4	499295.845	3928719.647		19	499271.486	3928690.587	4.11
P7	499296.948	3928715.008	18.90	14	499271.205	3928694.683	
P8	499301.321	3928696.624		3.17			

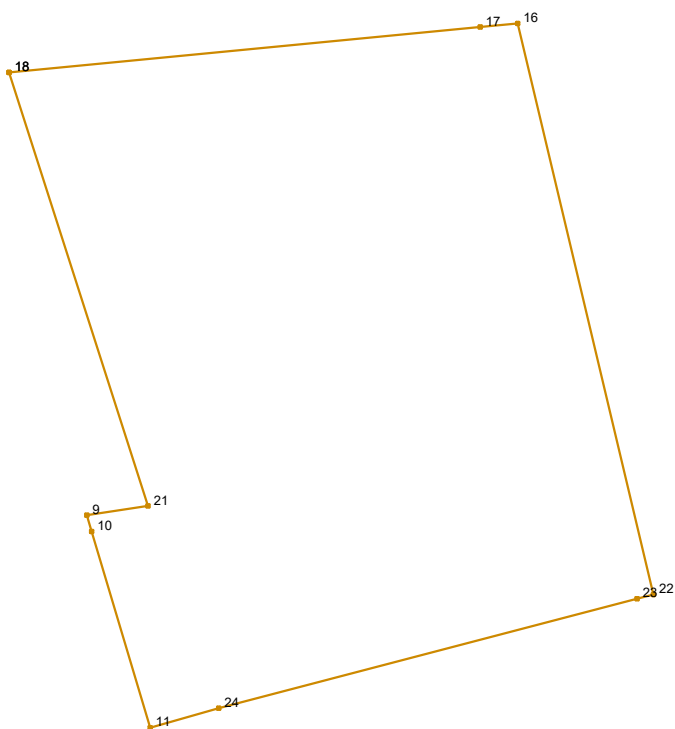

Νέα ιδιοκτησία εντός ΟΤ							
id1:1487		id2:06		Σημεία:10		Εμβαδό:501.58 m <sup>2</sup>	
Σημείο	X	Y	μήκος	Σημείο	X	Y	μήκος
18	499281.742	3928691.577	18.91	11	499287.379	3928665.404	8.17
17	499300.562	3928693.395	1.50	10	499285.038	3928673.236	0.69
16	499302.054	3928693.539	23.45	9	499284.842	3928673.893	2.48
22	499307.481	3928670.724	0.68	21	499287.294	3928674.268	18.18
23	499306.828	3928670.553	17.27	18	499281.742	3928691.577	
24	499290.118	3928666.183	2.85				



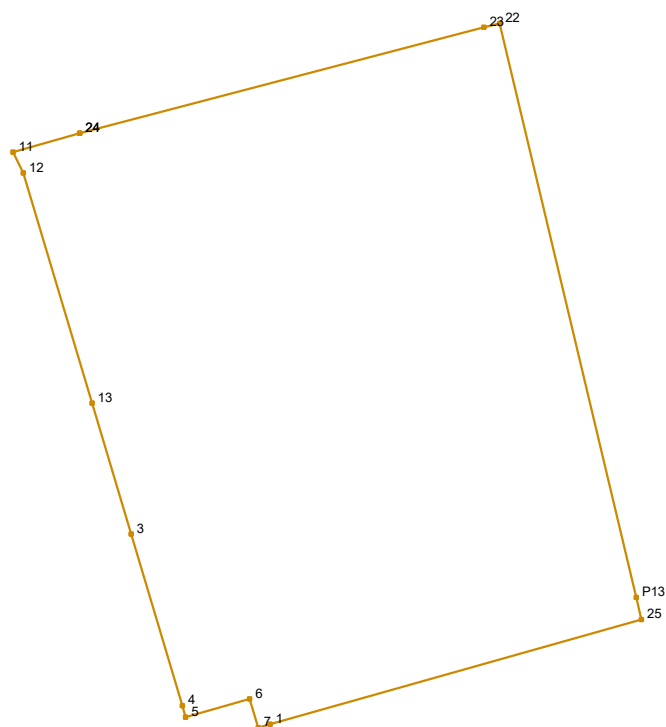

Νέα ιδιοκτησία εντός ΟΤ							
id1:1487		id2:07		Σημεία:14		Εμβαδό:504.67 m <sup>2</sup>	
Σημείο	X	Y	μήκος	Σημείο	X	Y	μήκος
24	499290.118	3928666.183	17.27	5	499294.507	3928642.051	0.49
23	499306.828	3928670.553	0.68	4	499294.367	3928642.522	7.41
22	499307.481	3928670.724	24.38	3	499292.250	3928649.621	5.64
P13	499313.124	3928647.002	0.94	13	499290.638	3928655.026	9.93
25	499313.341	3928646.087	15.95	12	499287.802	3928664.537	0.96
1	499297.994	3928641.753	0.51	11	499287.379	3928665.404	2.85
7	499297.502	3928641.614	1.23	24	499290.118	3928666.183	
6	499297.154	3928642.798	2.75				

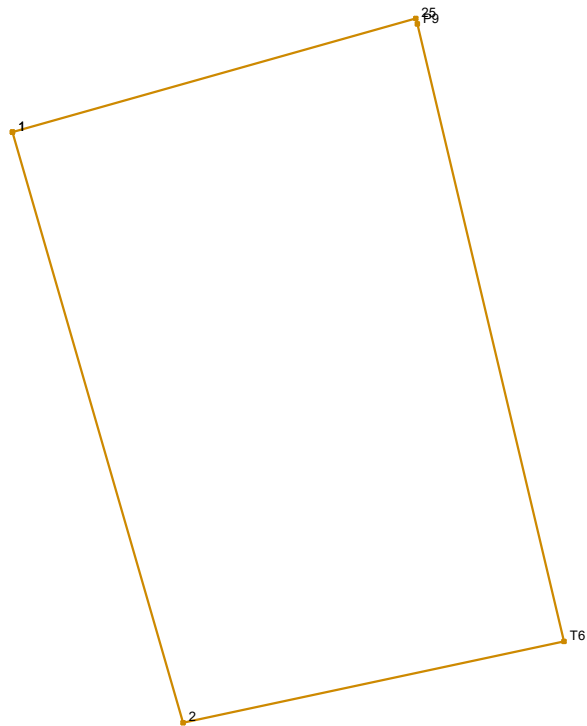

Νέα ιδιοκτησία εντός ΟΤ							
id1:1487		id2:08		Σημεία:5		Εμβαδό:366.98 m <sup>2</sup>	
Σημείο	X	Y	μήκος	Σημείο	X	Y	μήκος
1	499297.994	3928641.753	15.95	T6	499318.979	3928622.385	14.83
25	499313.341	3928646.087		0.22	2	499304.480	
P9	499313.392	3928645.874	24.14	1	499297.994	3928641.753	

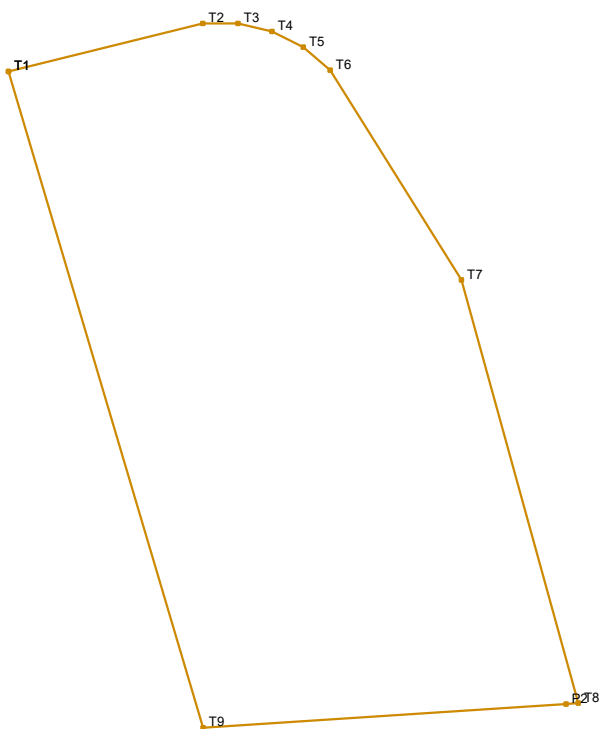

Νέα ιδιοκτησία εντός ΟΤ							
id1:1489		id2:01		Σημεία:10		Εμβαδό:1507.40 m <sup>2</sup>	
Σημείο	X	Y	μήκος	Σημείο	X	Y	μήκος
T1	499186.966	3928727.889	15.49	T7	499222.008	3928711.781	33.96
T2	499202.002	3928731.601		2.72	T8	499231.041	3928679.047
T3	499204.718	3928731.623	2.72	P2	499230.105	3928678.985	28.14
T4	499207.362	3928731.001	2.72	T9	499202.028	3928677.144	52.93
T5	499209.783	3928729.772	2.72	T1	499186.966	3928727.889	
T6	499211.846	3928728.005	19.14				

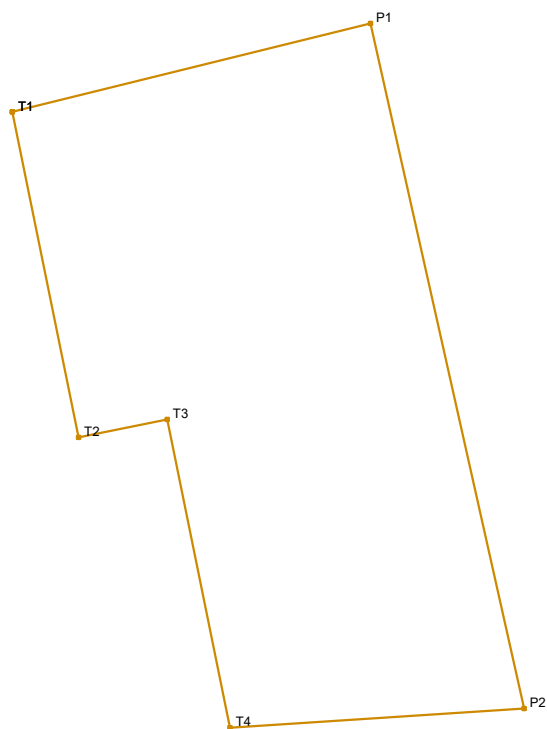

Νέα ιδιοκτησία εντός ΟΤ							
id1:1490		id2:01		Σημεία:6		Εμβαδό:978.73 m <sup>2</sup>	
Σημείο	X	Y	μήκος	Σημείο	X	Y	μήκος
T1	499131.855	3928714.283	24.44	T3	499142.118	3928693.901	6.00
P1	499155.587	3928720.142	46.50	T2	499136.238	3928692.706	22.02
P2	499165.760	3928674.764	19.54	T1	499131.855	3928714.283	
T4	499146.264	3928673.485	20.83				

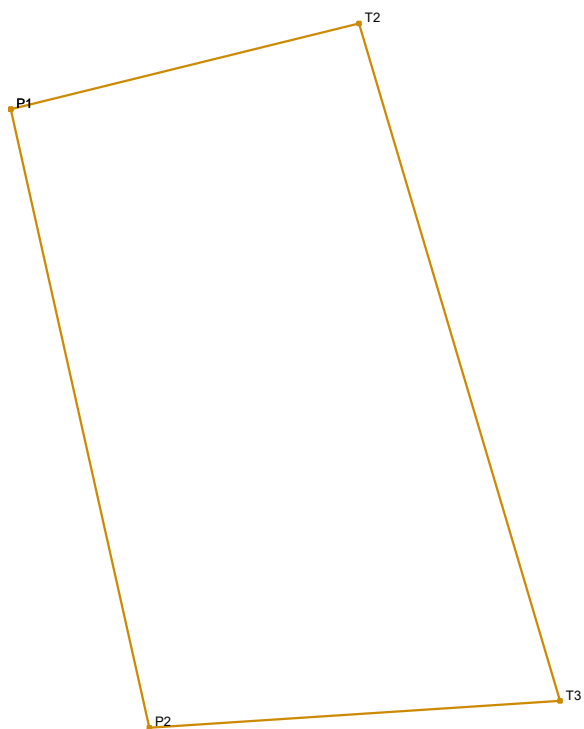

Νέα ιδιοκτησία εντός ΟΤ							
id1:1490		id2:02		Σημεία:4		Εμβαδό:1375.14 m <sup>2</sup>	
Σημείο	X	Y	μήκος	Σημείο	X	Y	μήκος
P1	499155.587	3928720.142	26.32	P2	499165.760	3928674.764	46.50
T2	499181.135	3928726.450		51.85	P1	499155.587	
T3	499195.889	3928676.741	30.19				

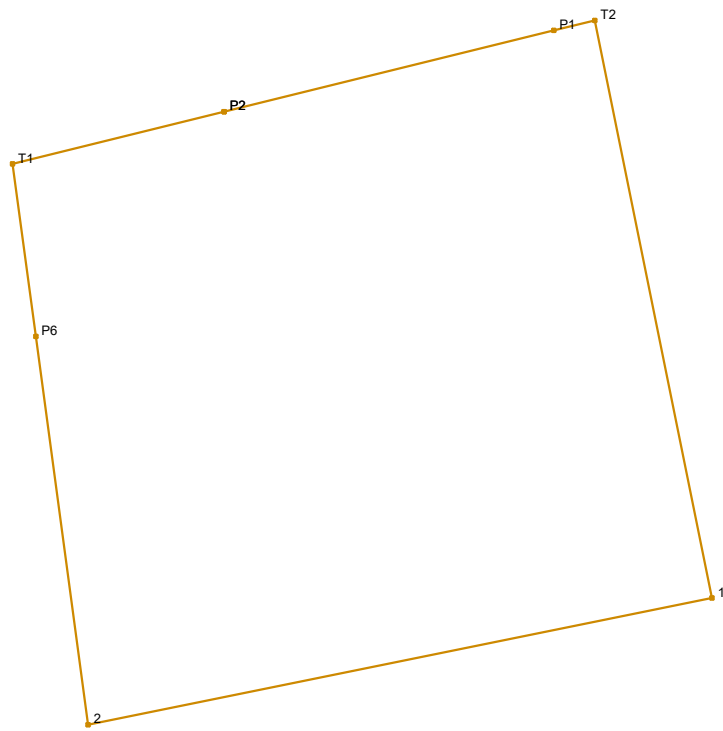

Νέα ιδιοκτησία εντός ΟΤ							
id1:1491		id2:01		Σημεία:7		Εμβαδό:400.00 m <sup>2</sup>	
Σημείο	X	Y	μήκος	Σημείο	X	Y	μήκος
P2	499109.723	3928708.819	11.38	2	499105.166	3928688.281	13.12
P1	499120.769	3928711.547		1.41	P6	499103.413	
T2	499122.138	3928711.885	19.75		T1	499102.633	3928707.069
1	499126.070	3928692.527		21.33	P2	499109.723	3928708.819

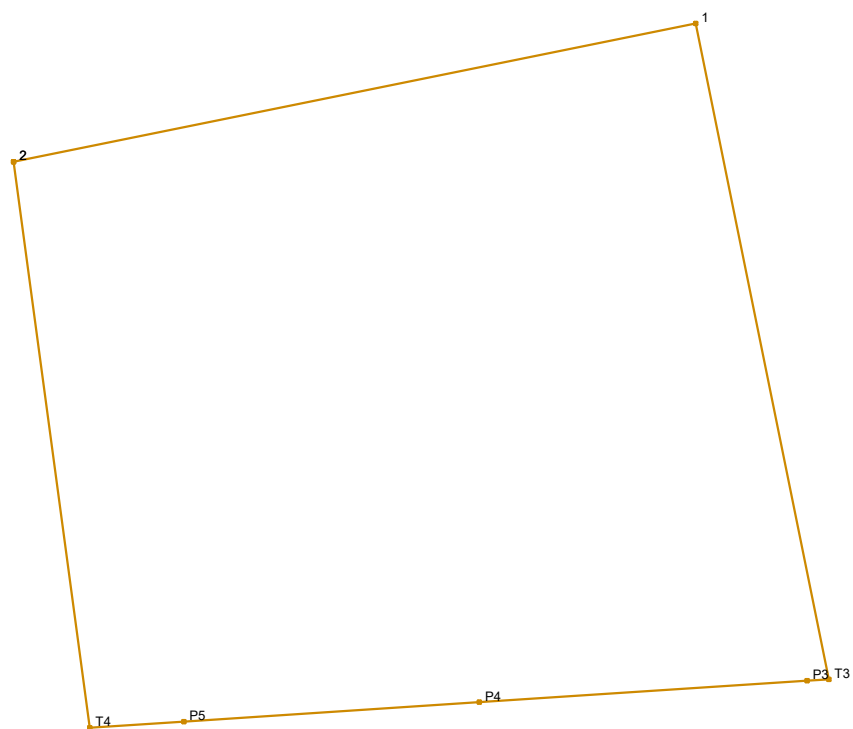

Νέα ιδιοκτησία εντός ΟΤ							
id1:1491		id2:02		Σημεία:7		Εμβαδό:416.84 m <sup>2</sup>	
Σημείο	X	Y	μήκος	Σημείο	X	Y	μήκος
2	499105.166	3928688.281	21.33	P4	499119.434	3928671.725	9.07
1	499126.070	3928692.527		20.51	P5	499110.385	
T3	499130.152	3928672.428	0.67		T4	499107.503	3928670.942
P3	499129.482	3928672.384		10.07	2	499105.166	3928688.281

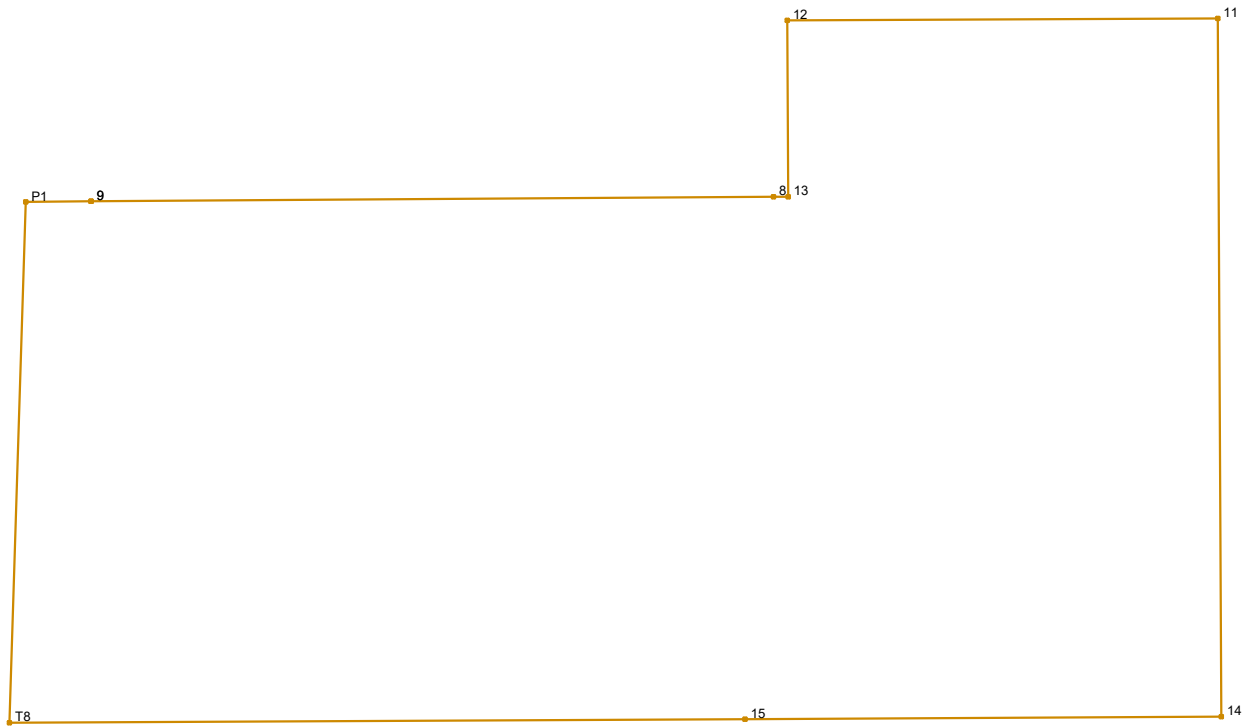

Νέα ιδιοκτησία εντός ΟΤ							
id1:1492		id2:01		Σημεία:9		Εμβαδό:550.14 m <sup>2</sup>	
Σημείο	X	Y	μήκος	Σημείο	X	Y	μήκος
9	499372.423	3928755.955	19.09	14	499404.031	3928741.539	13.32
8	499391.513	3928756.083	0.41	15	499390.708	3928741.473	20.57
13	499391.919	3928756.086	4.93	T8	499370.137	3928741.372	14.57
12	499391.894	3928761.012	12.04	P1	499370.592	3928755.937	1.83
11	499403.935	3928761.074	19.54	9	499372.423	3928755.955	



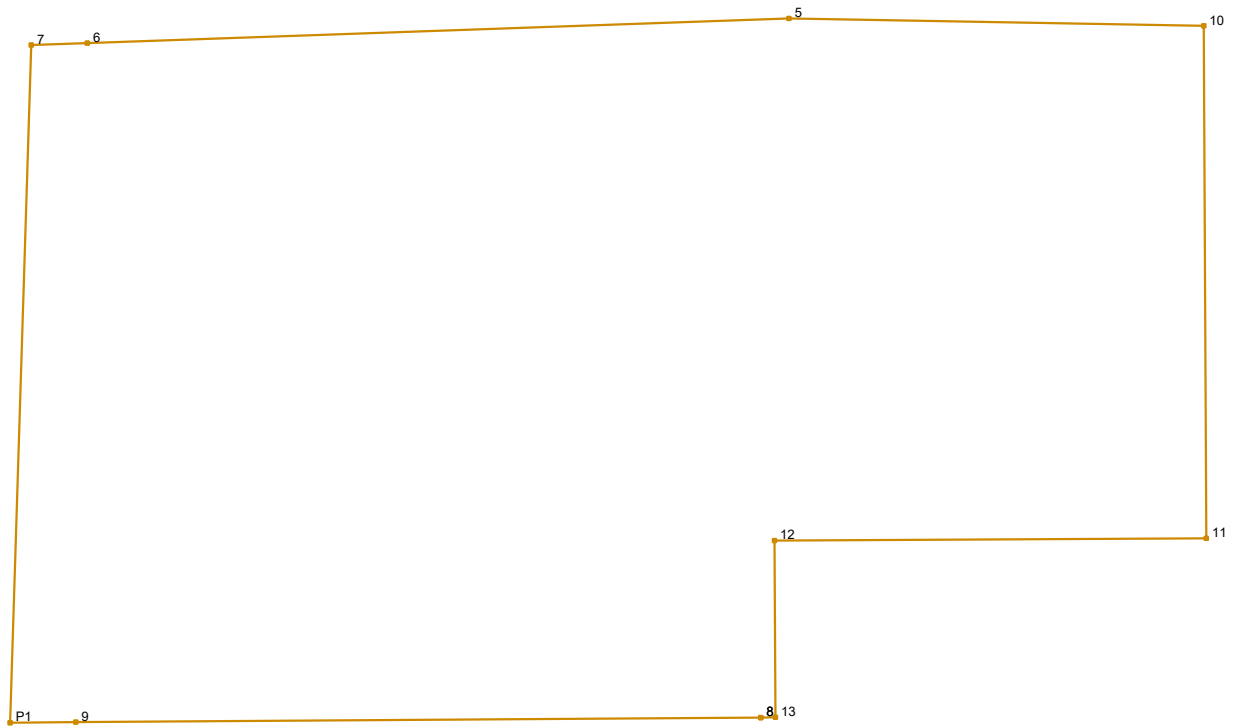

Νέα ιδιοκτησία εντός ΟΤ							
id1:1492		id2:02N		Σημεία:10		Εμβαδό:575.96 m <sup>2</sup>	
Σημείο	X	Y	μήκος	Σημείο	X	Y	μήκος
8	499391.513	3928756.083	19.09	10	499403.864	3928775.361	14.29
9	499372.423	3928755.955	1.83	11	499403.935	3928761.074	12.04
P1	499370.592	3928755.937	18.90	12	499391.894	3928761.012	4.93
7	499371.183	3928774.826	1.56	13	499391.919	3928756.086	0.41
6	499372.737	3928774.881	19.57	8	499391.513	3928756.083	
5	499392.294	3928775.570	11.57				

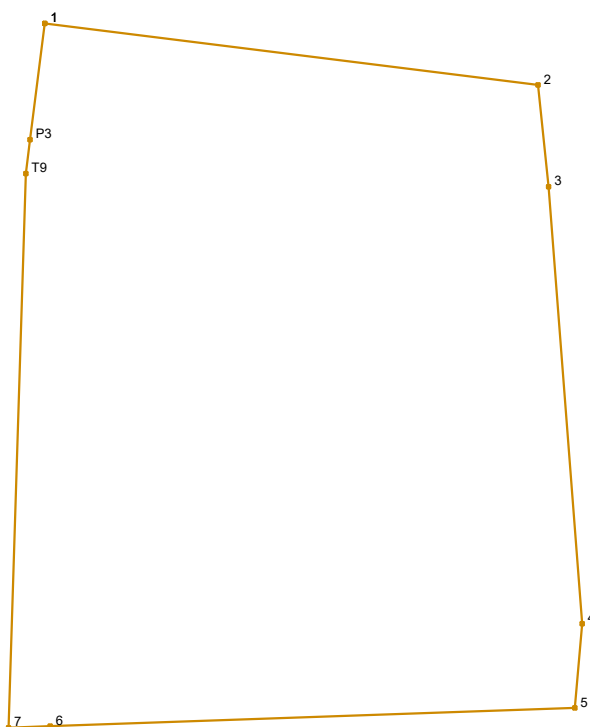

Νέα ιδιοκτησία εντός ΟΤ							
id1:1492		id2:03		Σημεία:9		Εμβαδό:500.00 m <sup>2</sup>	
Σημείο	X	Y	μήκος	Σημείο	X	Y	μήκος
1	499372.529	3928801.079	18.54	6	499372.737	3928774.881	1.56
2	499390.922	3928798.778	3.81	7	499371.183	3928774.826	20.66
3	499391.317	3928794.988	16.33	T9	499371.829	3928795.479	1.27
4	499392.561	3928778.705	3.15	P3	499371.986	3928796.738	4.37
5	499392.294	3928775.570	19.57	1	499372.529	3928801.079	

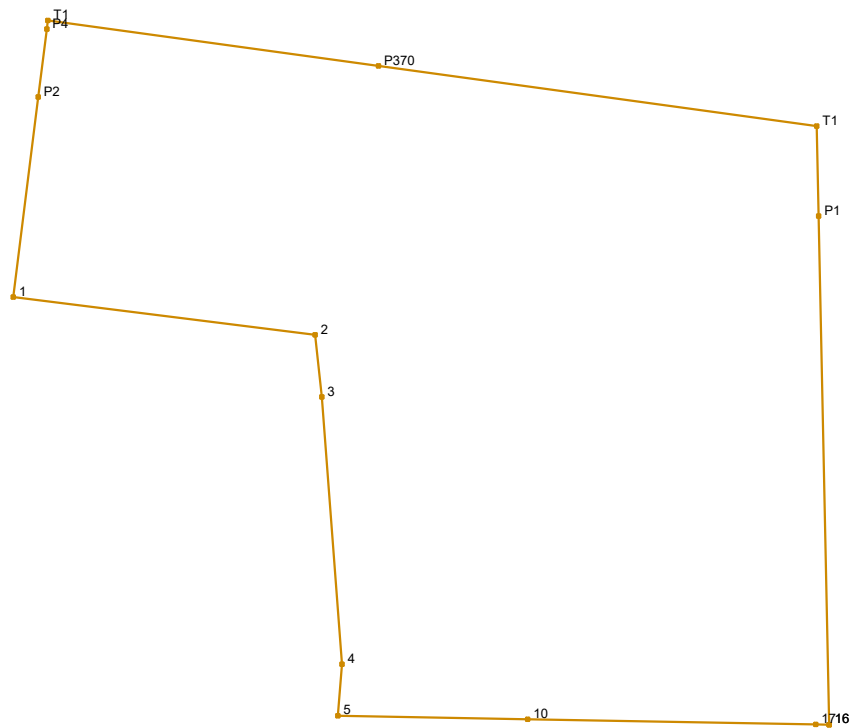

Νέα ιδιοκτησία εντός ΟΤ							
id1:1492		id2:04		Σημεία:14		Εμβαδό:1456.06 m <sup>2</sup>	
Σημείο	X	Y	μήκος	Σημείο	X	Y	μήκος
16	499422.235	3928775.030	0.82	P2	499374.054	3928813.271	4.16
17	499421.415	3928775.045	17.55	P4	499374.570	3928817.397	0.54
10	499403.864	3928775.361	11.57	T1	499374.637	3928817.932	20.33
5	499392.294	3928775.570	3.15	P370	499394.781	3928815.159	26.94
4	499392.561	3928778.705	16.33	T1	499421.469	3928811.485	5.48
3	499391.317	3928794.988	3.81	P1	499421.584	3928806.009	30.99
2	499390.922	3928798.778	18.54	16	499422.235	3928775.030	
1	499372.529	3928801.079	12.29				

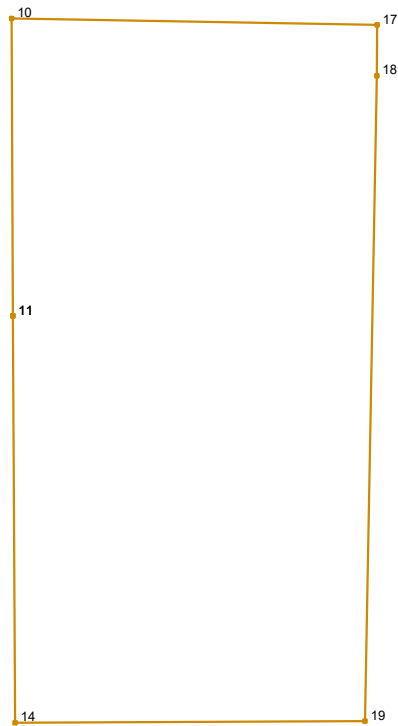

Νέα ιδιοκτησία εντός ΟΤ							
id1:1492		id2:05N		Σημεία:6		Εμβαδό:577.95 m <sup>2</sup>	
Σημείο	X	Y	μήκος	Σημείο	X	Y	μήκος
11	499403.935	3928761.074	14.29	19	499420.828	3928741.622	16.80
10	499403.864	3928775.361		17.55	14	499404.031	
17	499421.415	3928775.045	2.45	11	499403.935	3928761.074	
18	499421.401	3928772.598	30.98				

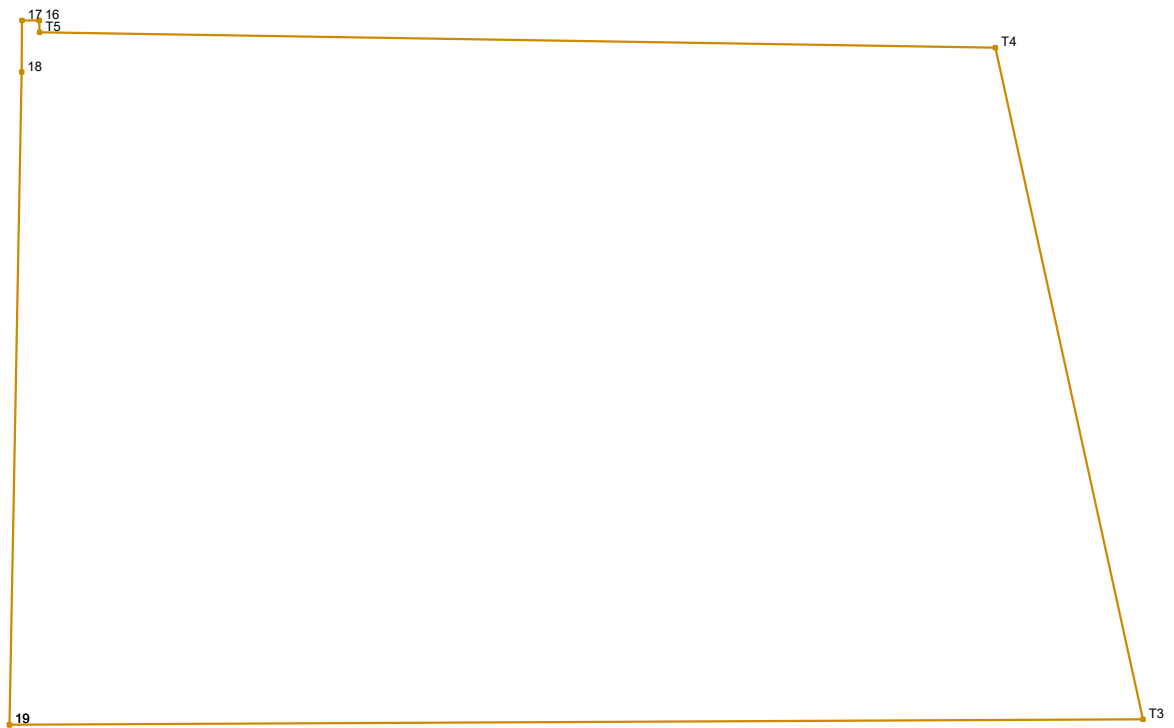

Νέα ιδιοκτησία εντός ΟΤ							
id1:1492		id2:06		Σημεία:7		Εμβαδό:1616.74 m <sup>2</sup>	
Σημείο	X	Y	μήκος	Σημείο	X	Y	μήκος
19	499420.828	3928741.622	30.98	T5	499422.247	3928774.471	45.36
18	499421.401	3928772.598		T4	499467.599	3928773.741	32.62
17	499421.415	3928775.045	2.45	T3	499474.612	3928741.887	53.78
16	499422.235	3928775.030	0.82	19	499420.828	3928741.622	
			0.56				

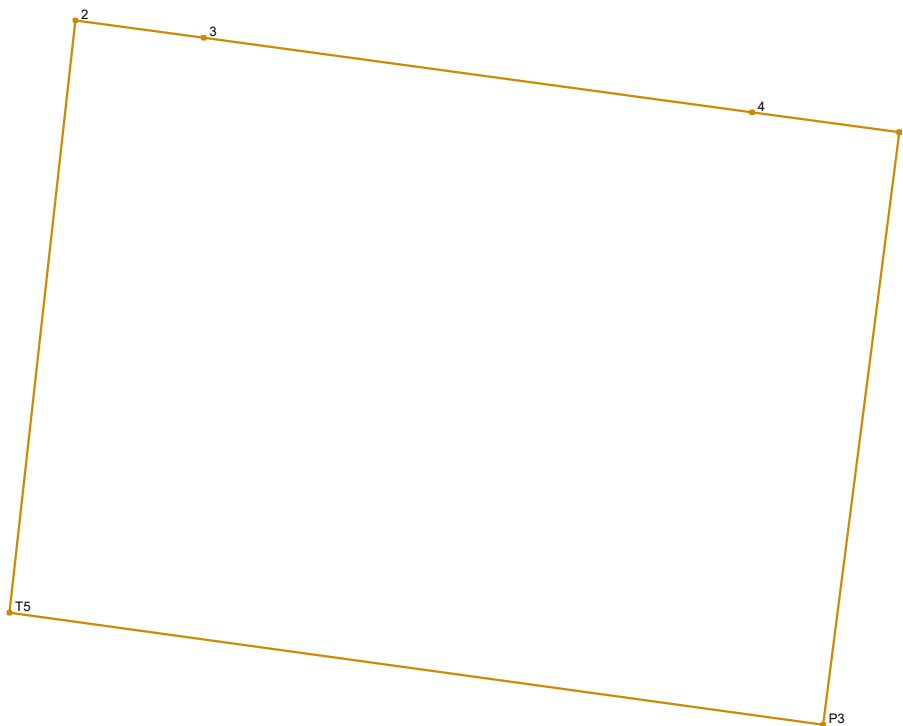

Νέα ιδιοκτησία εντός ΟΤ							
id1:1493		id2:01		Σημεία:6		Εμβαδό:474.66 m <sup>2</sup>	
Σημείο	X	Y	μήκος	Σημείο	X	Y	μήκος
1	499403.427	3928842.767	18.53	3	499381.842	3928845.701	17.17
P3	499401.068	3928824.388		4	499398.855	3928843.389	
T5	499375.813	3928827.864	25.49	1	499403.427	3928842.767	
2	499377.863	3928846.242	18.49				
			4.02				

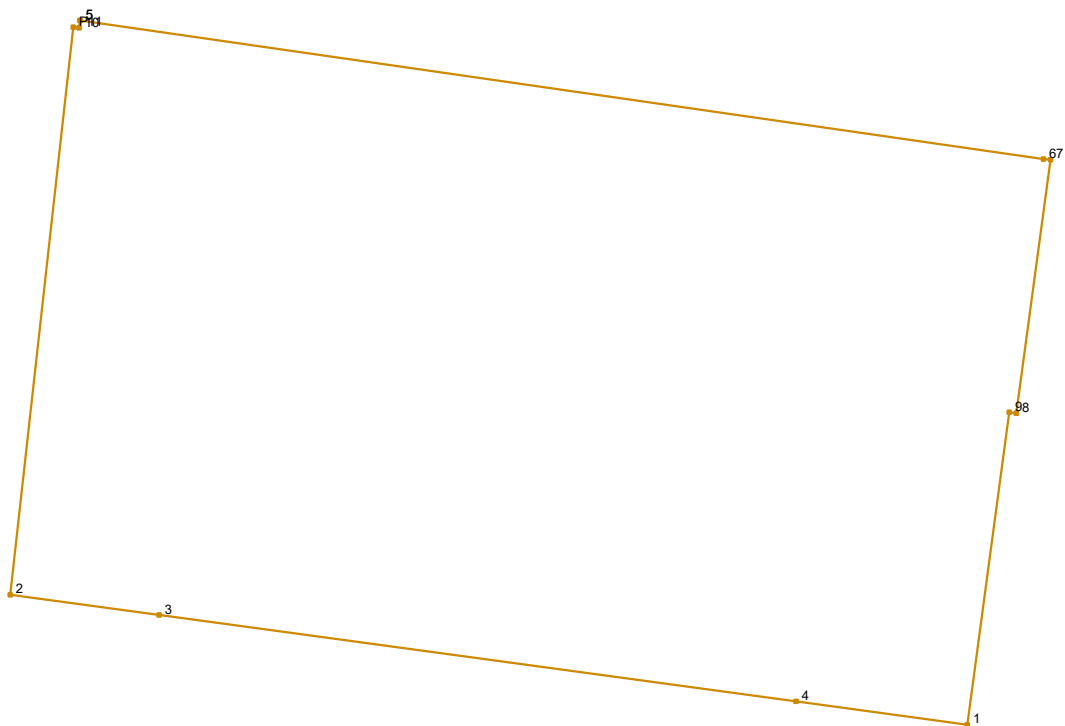

Νέα ιδιοκτησία εντός ΟΤ							
id1:1493		id2:02		Σημεία:11		Εμβαδό:400.00 m <sup>2</sup>	
Σημείο	X	Y	μήκος	Σημείο	X	Y	μήκος
5	499379.725	3928861.582	26.01	4	499398.855	3928843.389	17.17
6	499405.467	3928857.879	0.19	3	499381.842	3928845.701	4.02
7	499405.652	3928857.855	6.83	2	499377.863	3928846.242	15.25
8	499404.738	3928851.088	0.19	P11	499379.553	3928861.402	0.15
9	499404.554	3928851.113	8.42	10	499379.701	3928861.383	0.20
1	499403.427	3928842.767	4.61	5	499379.725	3928861.582	

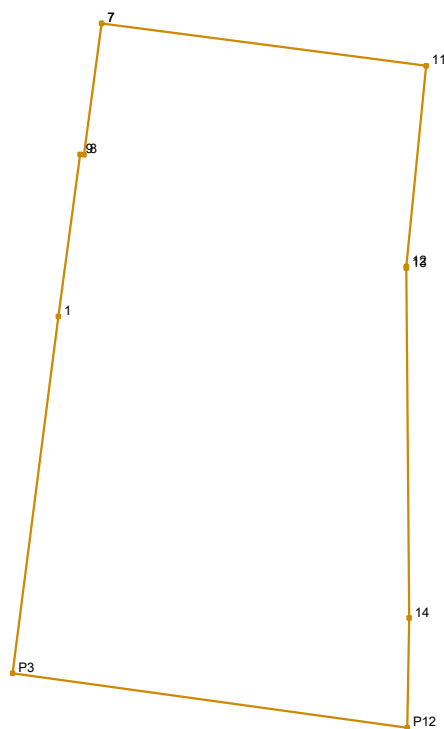

Νέα ιδιοκτησία εντός ΟΤ							
id1:1493		id2:03		Σημεία:10		Εμβαδό:623.84 m <sup>2</sup>	
Σημείο	X	Y	μήκος	Σημείο	X	Y	μήκος
7	499405.652	3928857.855	16.84	P3	499401.068	3928824.388	18.53
11	499422.353	3928855.677	10.39	1	499403.427	3928842.767	8.42
12	499421.341	3928845.336	0.08	9	499404.554	3928851.113	0.19
13	499421.333	3928845.255	18.01	8	499404.738	3928851.088	6.83
14	499421.483	3928827.246	5.66	7	499405.652	3928857.855	
P12	499421.388	3928821.591	20.51				



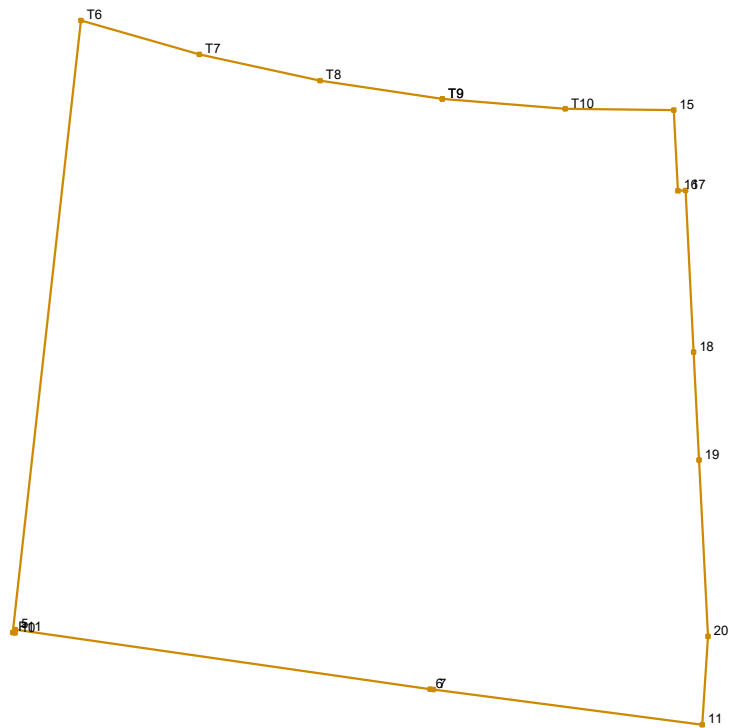

Νέα ιδιοκτησία εντός ΟΤ							
id1:1493		id2:04		Σημεία:17		Εμβαδό:1500.27 m <sup>2</sup>	
Σημείο	X	Y	μήκος	Σημείο	X	Y	μήκος
T9	499406.210	3928894.511		7	499405.652	3928857.855	
			7.66				0.19
T10	499413.845	3928893.897		6	499405.467	3928857.879	
			6.74				26.01
15	499420.580	3928893.808		5	499379.725	3928861.582	
			5.00				0.20
16	499420.827	3928888.815		10	499379.701	3928861.383	
			0.49				0.15
17	499421.312	3928888.839		P11	499379.553	3928861.402	
			10.05				38.22
18	499421.809	3928878.801		T6	499383.789	3928899.387	
			6.70				7.66
19	499422.153	3928872.108		T7	499391.148	3928897.262	
			10.95				7.66
20	499422.698	3928861.169		T8	499398.633	3928895.634	
			5.50				7.66
11	499422.353	3928855.677		T9	499406.210	3928894.511	
			16.84				

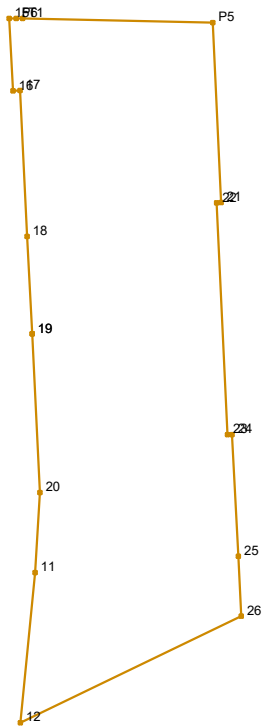

Νέα ιδιοκτησία εντός ΟΤ							
id1:1493		id2:05		Σημεία:17		Εμβαδό:605.82 m <sup>2</sup>	
Σημείο	X	Y	μήκος	Σημείο	X	Y	μήκος
19	499422.153	3928872.108	6.70	22	499434.855	3928881.114	15.96
18	499421.809	3928878.801		23	499435.600	3928865.169	0.30
17	499421.312	3928888.839	10.05	24	499435.900	3928865.171	8.40
16	499420.827	3928888.815	0.49	25	499436.335	3928856.782	4.12
15	499420.580	3928893.808	5.00	26	499436.548	3928852.668	16.88
P6	499421.066	3928893.802	0.49	12	499421.341	3928845.336	10.39
T1	499421.504	3928893.796	0.44	11	499422.353	3928855.677	5.50
P5	499434.576	3928893.501	13.08	20	499422.698	3928861.169	10.95
Z1	499435.154	3928881.128	12.39	19	499422.153	3928872.108	
			0.30				

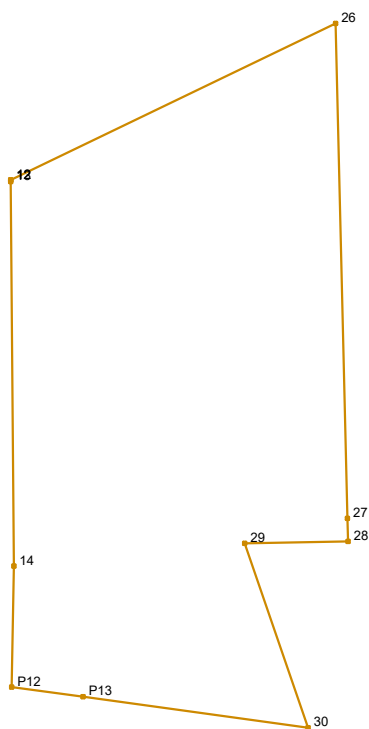

Νέα ιδιοκτησία εντός ΟΤ							
id1:1493		id2:06		Σημεία:10		Εμβαδό:413.82 m <sup>2</sup>	
Σημείο	X	Y	μήκος	Σημείο	X	Y	μήκος
12	499421.341	3928845.336	16.88	P13	499424.719	3928821.132	3.36
26	499436.548	3928852.668	23.18	P12	499421.388	3928821.591	5.66
27	499437.110	3928829.490	1.08	14	499421.483	3928827.246	18.01
28	499437.136	3928828.408	4.85	13	499421.333	3928845.255	0.08
29	499432.290	3928828.312	9.13	12	499421.341	3928845.336	
30	499435.257	3928819.682	10.64				

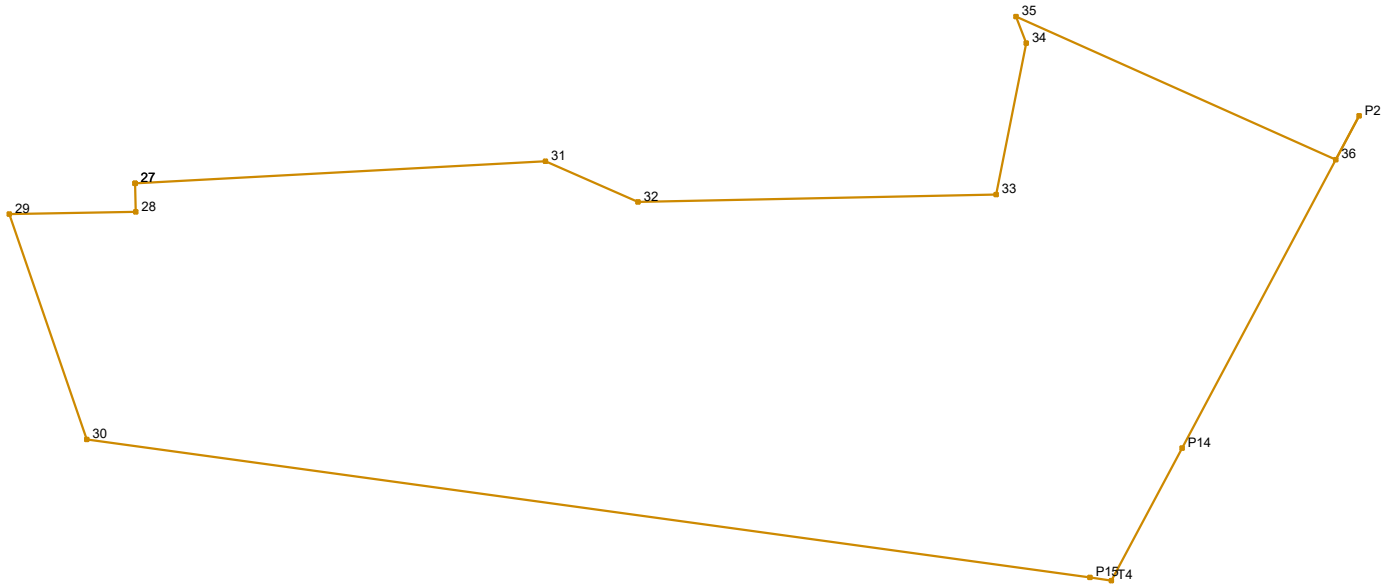

Νέα ιδιοκτησία εντός ΟΤ							
id1:1493		id2:07		Σημεία:14		Εμβαδό:608.22 m <sup>2</sup>	
Σημείο	X	Y	μήκος	Σημείο	X	Y	μήκος
27	499437.110	3928829.490	15.75	P14	499477.238	3928819.354	5.76
31	499452.840	3928830.338	3.87	T4	499474.529	3928814.276	0.83
32	499456.384	3928828.789	13.73	P15	499473.702	3928814.390	38.81
33	499470.114	3928829.061	5.92	30	499435.257	3928819.682	9.13
34	499471.258	3928834.865	1.09	29	499432.290	3928828.312	4.85
35	499470.873	3928835.888	13.43	28	499437.136	3928828.408	1.08
36	499483.129	3928830.401	1.90	27	499437.110	3928829.490	
P2	499484.026	3928832.082	14.42				

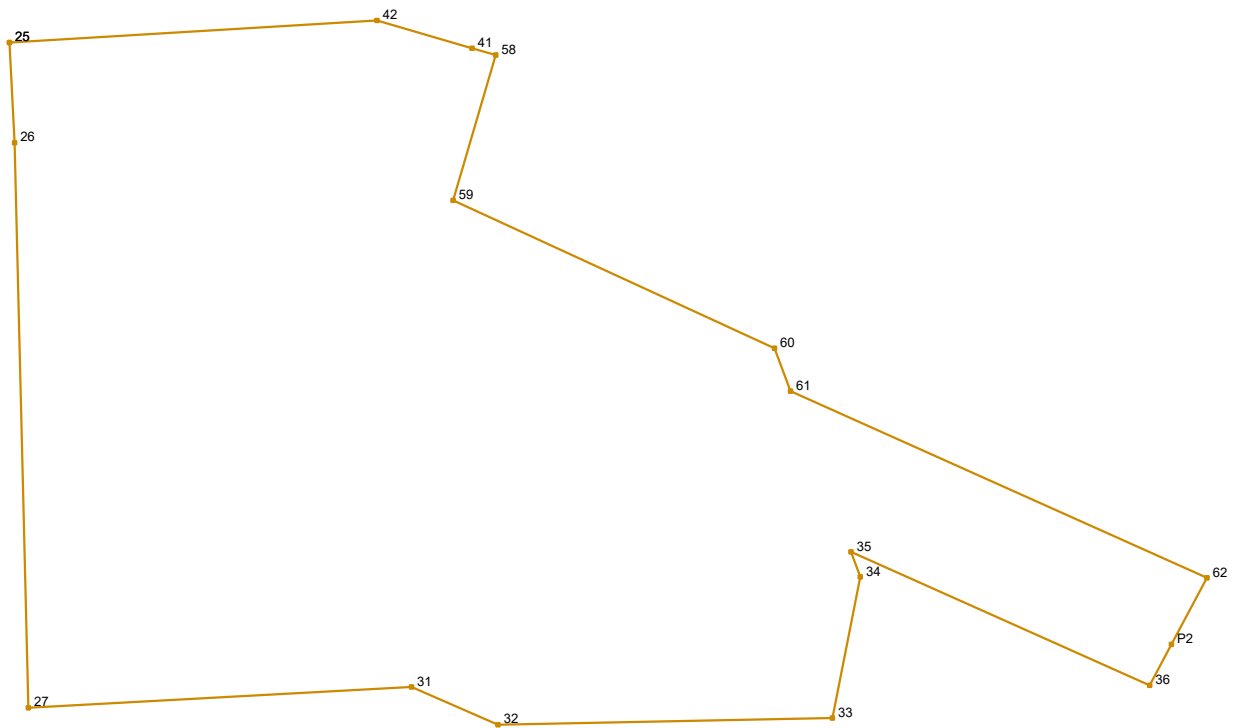

Νέα ιδιοκτησία εντός ΟΤ							
id1:1493		id2:08		Σημεία:17		Εμβαδό:847.38 m <sup>2</sup>	
Σημείο	X	Y	μήκος	Σημείο	X	Y	μήκος
25	499436.335	3928856.782		36	499483.129	3928830.401	13.43
42	499451.411	3928857.698	15.10	35	499470.873	3928835.888	1.09
41	499455.318	3928856.554	4.07	34	499471.258	3928834.865	5.92
58	499456.292	3928856.268	1.02	33	499470.114	3928829.061	13.73
59	499454.545	3928850.304	6.21	32	499456.384	3928828.789	3.87
60	499467.732	3928844.232	14.52	31	499452.840	3928830.338	15.75
61	499468.393	3928842.477	1.88	27	499437.110	3928829.490	23.18
62	499485.488	3928834.823	18.73	26	499436.548	3928852.668	4.12
P2	499484.026	3928832.082	3.11	25	499436.335	3928856.782	
			1.90				

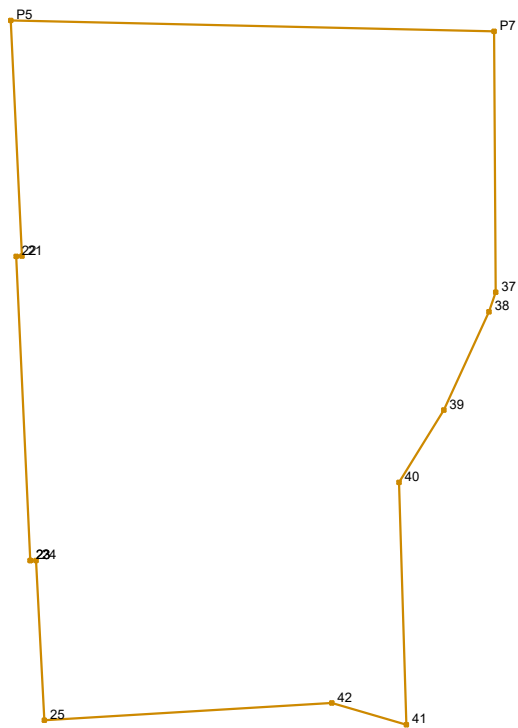

Νέα ιδιοκτησία εντός ΟΤ							
id1:1493		id2:09		Σημεία:13		Εμβαδό:807.09 m <sup>2</sup>	
Σημείο	X	Y	μήκος	Σημείο	X	Y	μήκος
23	499435.600	3928865.169	15.96	39	499457.287	3928873.055	4.46
22	499434.855	3928881.114	0.30	40	499454.941	3928869.259	12.71
21	499435.154	3928881.128	12.39	41	499455.318	3928856.554	4.07
P5	499434.576	3928893.501	25.36	42	499451.411	3928857.698	15.10
P7	499459.927	3928892.930	13.68	25	499436.335	3928856.782	8.40
37	499460.013	3928879.245	1.09	24	499435.900	3928865.171	0.30
38	499459.660	3928878.217	5.68	23	499435.600	3928865.169	

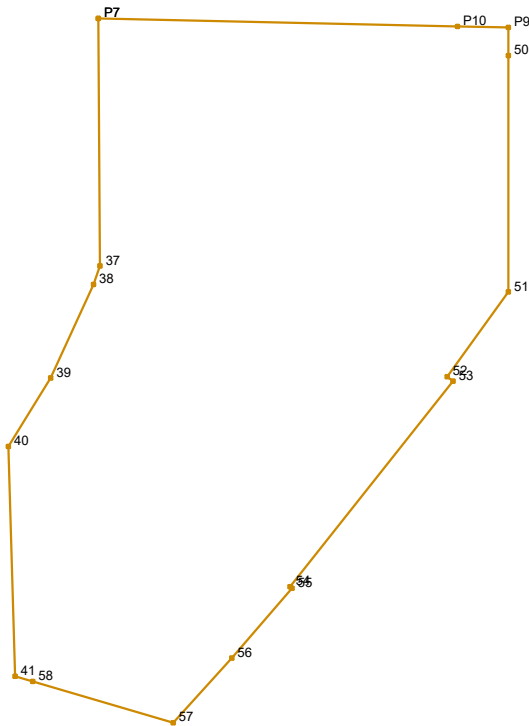

Νέα ιδιοκτησία εντός ΟΤ							
id1:1493		id2:10N		Σημεία:17		Εμβαδό:750.93 m <sup>2</sup>	
Σημείο	X	Y	μήκος	Σημείο	X	Y	μήκος
P7	499459.927	3928892.930		56	499467.307	3928857.563	
			19.85				4.83
P10	499479.769	3928892.482		57	499464.057	3928853.994	
			2.82				8.09
P9	499482.588	3928892.418		58	499456.292	3928856.268	
			1.55				1.02
50	499482.587	3928890.871		41	499455.318	3928856.554	
			13.06				12.71
51	499482.586	3928877.811		40	499454.941	3928869.259	
			5.77				4.46
52	499479.214	3928873.128		39	499457.287	3928873.055	
			0.41				5.68
53	499479.532	3928872.875		38	499459.660	3928878.217	
			14.50				1.09
54	499470.521	3928861.519		37	499460.013	3928879.245	
			0.15				13.68
55	499470.632	3928861.417		P7	499459.927	3928892.930	
			5.09				

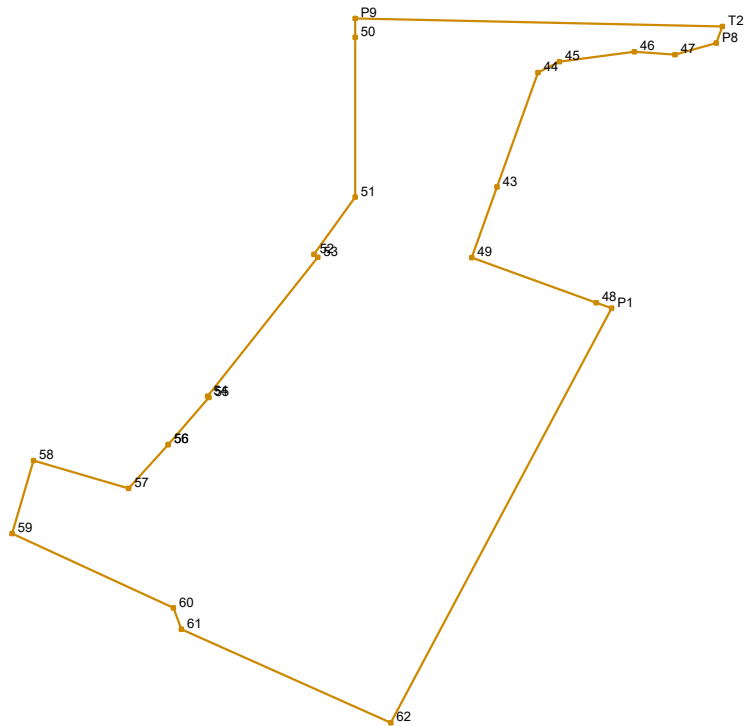

Νέα ιδιοκτησία εντός ΟΤ							
ιδ1:1493		ιδ2:11N		Σημεία:24		Εμβαδό:1272.48 m <sup>2</sup>	
Σημείο	X	Y	μήκος	Σημείο	X	Y	μήκος
56	499467.307	3928857.563	5.09	44	499497.539	3928887.995	9.95
55	499470.632	3928861.417	0.15	43	499494.181	3928878.625	6.12
54	499470.521	3928861.519	14.50	49	499492.116	3928872.864	10.83
53	499479.532	3928872.875	0.41	48	499502.295	3928869.154	1.34
52	499479.214	3928873.128	5.77	P1	499503.567	3928868.720	38.42
51	499482.586	3928877.811	13.06	62	499485.488	3928834.823	18.73
50	499482.587	3928890.871	1.55	61	499468.393	3928842.477	1.88
P9	499482.588	3928892.418	30.04	60	499467.732	3928844.232	14.52
T2	499512.618	3928891.741	1.45	59	499454.545	3928850.304	6.21
P8	499512.107	3928890.388	3.51	58	499456.292	3928856.268	8.09
47	499508.732	3928889.438	3.32	57	499464.057	3928853.994	4.83
46	499505.417	3928889.676	6.19	56	499467.307	3928857.563	
45	499499.280	3928888.869	1.95				



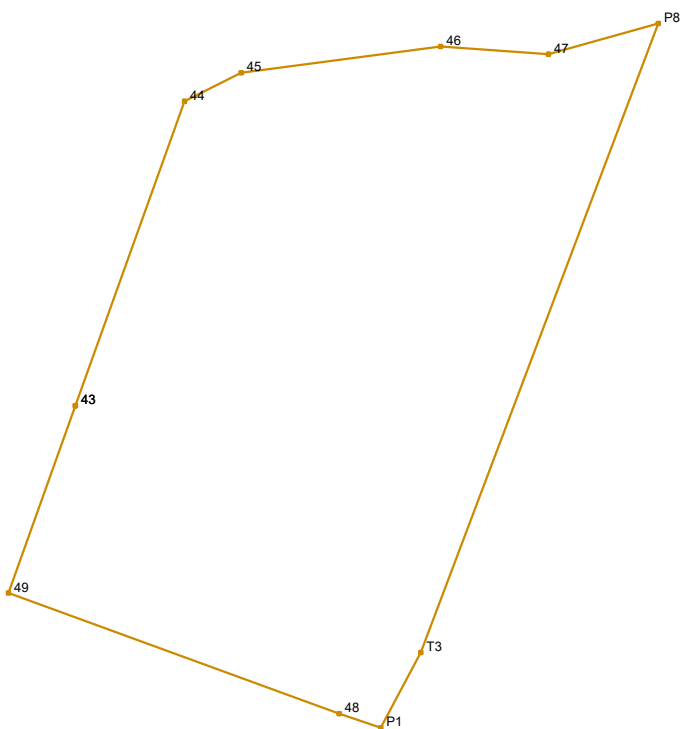

Νέα ιδιοκτησία εντός ΟΤ							
id1:1493		id2:12		Σημεία:10		Εμβαδό:251.94 m <sup>2</sup>	
Σημείο	X	Y	μήκος	Σημείο	X	Y	μήκος
43	499494.181	3928878.625	9.95	T3	499504.801	3928871.035	2.62
44	499497.539	3928887.995		1.95	P1	499503.567	
45	499499.280	3928888.869	6.19	48	499502.295	3928869.154	10.83
46	499505.417	3928889.676	3.32	49	499492.116	3928872.864	6.12
47	499508.732	3928889.438	3.51	43	499494.181	3928878.625	
P8	499512.107	3928890.388	20.69				

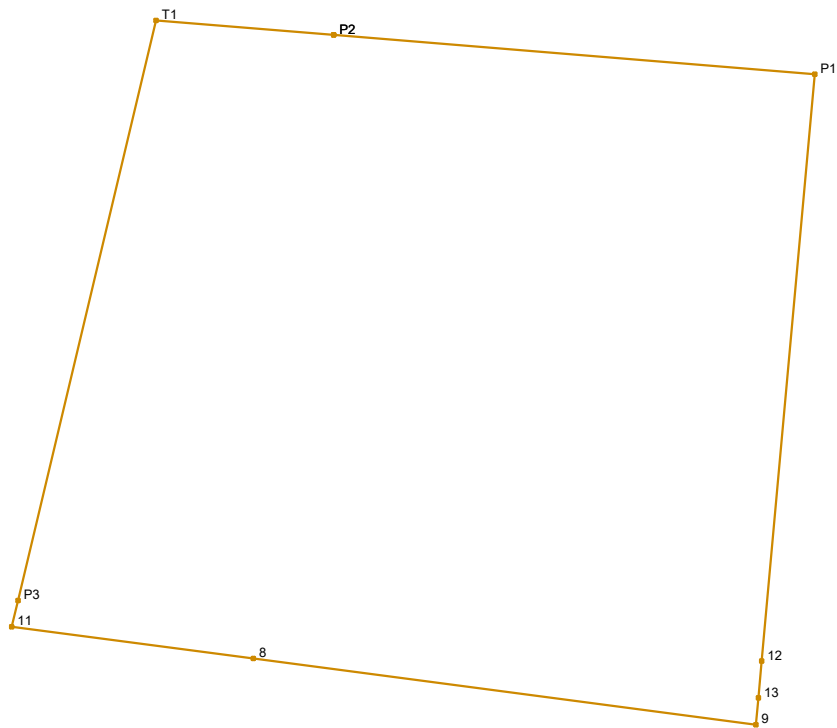

Νέα ιδιοκτησία εντός ΟΤ							
id1:1494		id2:01N		Σημεία:9		Εμβαδό:639.25 m <sup>2</sup>	
Σημείο	X	Y	μήκος	Σημείο	X	Y	μήκος
P2	499277.451	3928808.155	18.22	8	499274.417	3928784.611	9.20
P1	499295.611	3928806.669		11	499265.294	3928785.811	1.02
12	499293.605	3928784.524	1.40	P3	499265.530	3928786.803	22.51
13	499293.479	3928783.125		T1	499270.740	3928808.704	6.73
9	499293.387	3928782.114	1.02	P2	499277.451	3928808.155	
			19.13				

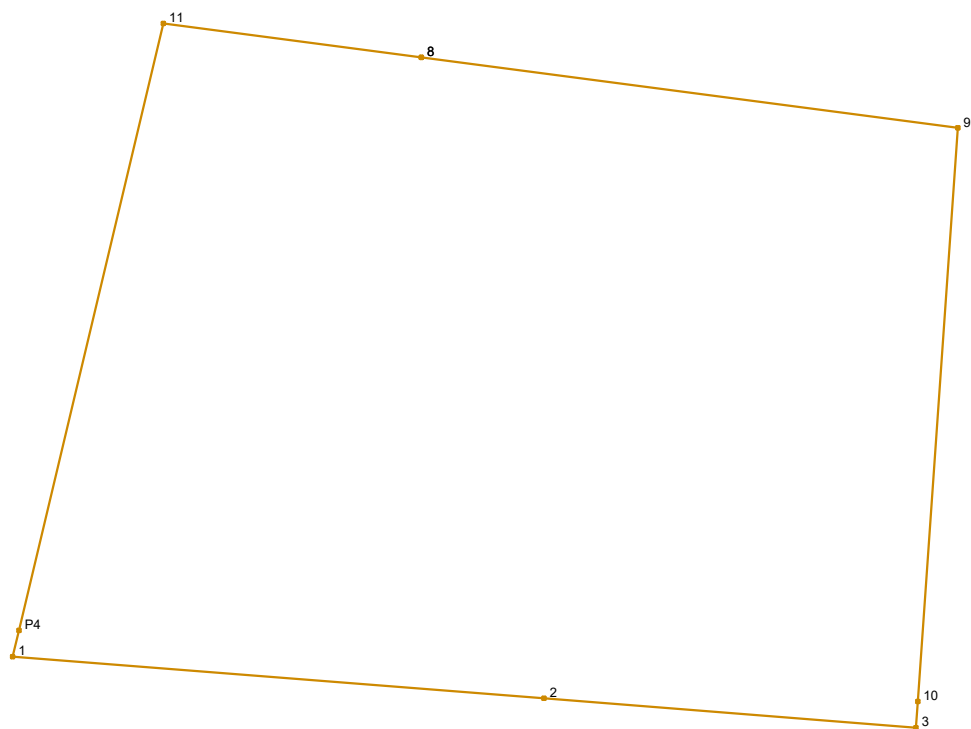

Νέα ιδιοκτησία εντός ΟΤ							
id1:1494		id2:02N		Σημεία:8		Εμβαδό:664.90 m <sup>2</sup>	
Σημείο	X	Y	μήκος	Σημείο	X	Y	μήκος
8	499274.417	3928784.611	19.13	1	499259.968	3928763.422	0.94
9	499293.387	3928782.114	20.33	P4	499260.187	3928764.341	22.07
10	499291.970	3928761.835	0.93	11	499265.294	3928785.811	9.20
3	499291.905	3928760.904	13.19	8	499274.417	3928784.611	
2	499278.757	3928761.941	18.85				

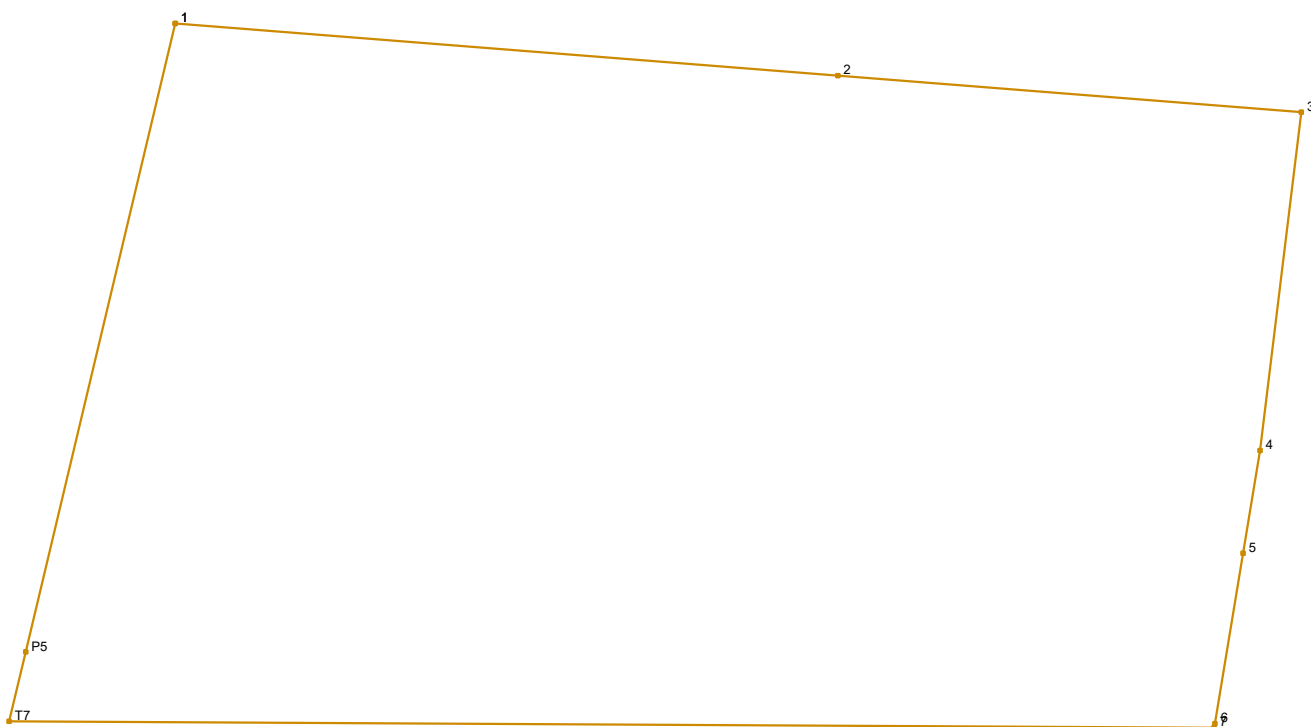

Νέα ιδιοκτησία εντός ΟΤ							
id1:1494		id2:03N		Σημεία:9		Εμβαδό:622.16 m <sup>2</sup>	
Σημείο	X	Y	μήκος	Σημείο	X	Y	μήκος
1	499259.968	3928763.422	18.85	6	499289.448	3928743.566	0.12
2	499278.757	3928761.941	13.19	7	499289.428	3928743.446	34.17
3	499291.905	3928760.904	9.67	T7	499255.259	3928743.625	2.03
4	499290.729	3928751.303	2.95	P5	499255.727	3928745.595	18.32
5	499290.247	3928748.392	4.89	1	499259.968	3928763.422	

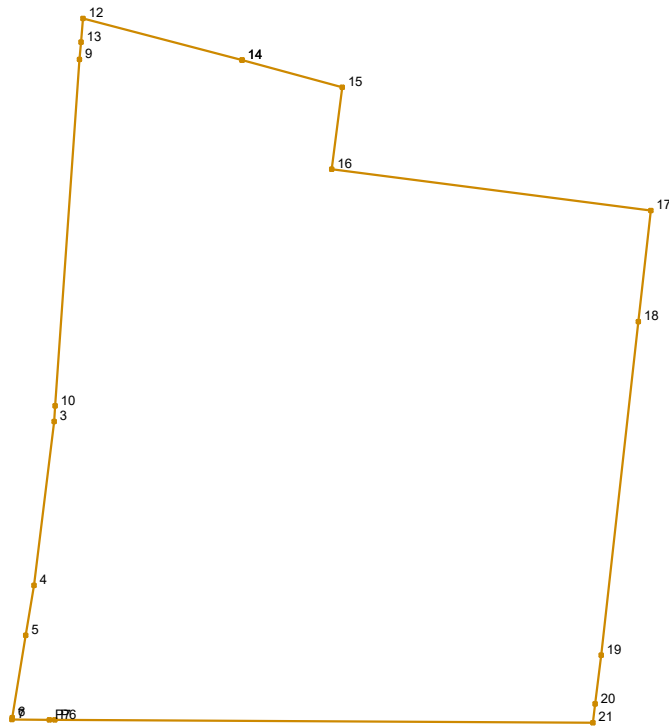

Νέα ιδιοκτησία εντός ΟΤ							
ιδ1:1494		ιδ2:04		Σημεία:19		Εμβαδό:1175.39 m <sup>2</sup>	
Σημείο	X	Y	μήκος	Σημείο	X	Y	μήκος
14	499302.918	3928782.078		7	499289.428	3928743.446	
			6.08				0.12
15	499308.793	3928780.492		6	499289.448	3928743.566	
			4.85				4.89
16	499308.169	3928775.686		5	499290.247	3928748.392	
			18.84				2.95
17	499326.854	3928773.261		4	499290.729	3928751.303	
			6.54				9.67
18	499326.131	3928766.758		3	499291.905	3928760.904	
			19.65				0.93
19	499323.960	3928747.228		10	499291.970	3928761.835	
			2.88				20.33
20	499323.598	3928744.373		9	499293.387	3928782.114	
			1.11				1.02
21	499323.458	3928743.268		13	499293.479	3928783.125	
			31.52				1.40
P6	499291.941	3928743.433		12	499293.605	3928784.524	
			0.30				9.63
P7	499291.636	3928743.435		14	499302.918	3928782.078	
			2.21				

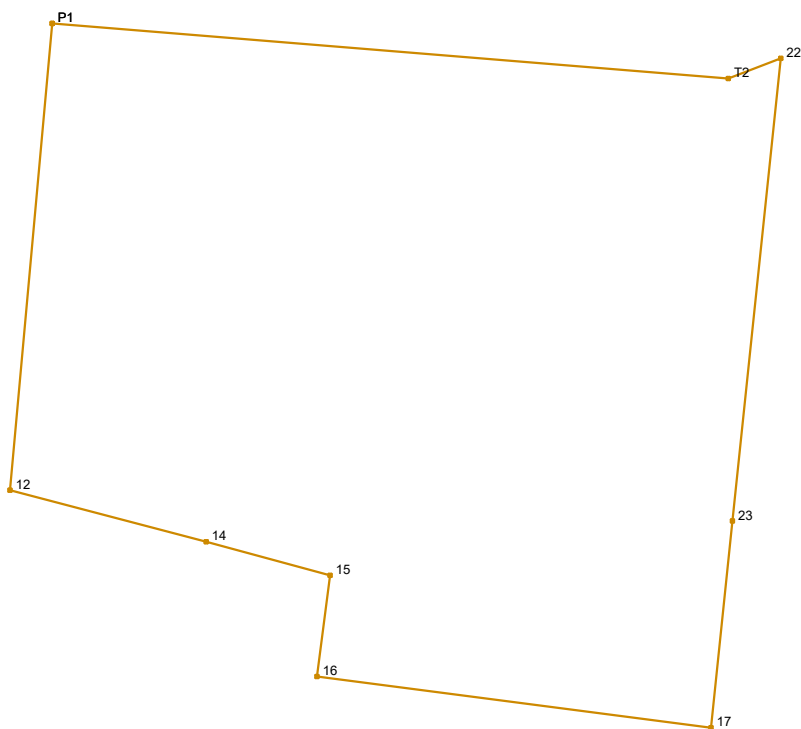

Νέα ιδιοκτησία εντός ΟΤ							
id1:1494		id2:05		Σημεία:9		Εμβαδό:938.84 m <sup>2</sup>	
Σημείο	X	Y	μήκος	Σημείο	X	Y	μήκος
P1	499295.611	3928806.669	32.17	16	499308.169	3928775.686	4.85
T2	499327.672	3928804.045		2.67	15	499308.793	3928780.492
22	499330.159	3928805.014	22.06	14	499302.918	3928782.078	9.63
23	499327.875	3928783.070	9.86	12	499293.605	3928784.524	22.24
17	499326.854	3928773.261	18.84	P1	499295.611	3928806.669	

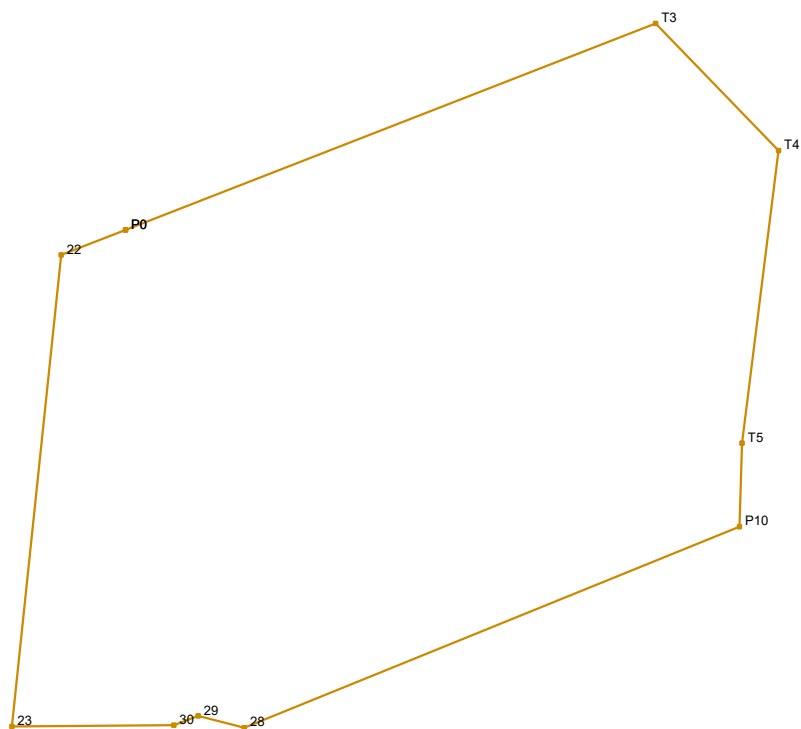

Νέα ιδιοκτησία εντός ΟΤ							
id1:1494		id2:06		Σημεία:10		Εμβαδό:808.77 m <sup>2</sup>	
Σημείο	X	Y	μήκος	Σημείο	X	Y	μήκος
P0	499333.159	3928806.183	26.48	29	499336.543	3928783.563	1.22
T3	499357.833	3928815.798		8.23	30	499335.405	3928783.129
T4	499363.551	3928809.874	13.72	23	499327.875	3928783.070	22.06
T5	499361.848	3928796.257	3.89	22	499330.159	3928805.014	3.22
P10	499361.727	3928792.373	24.87	P0	499333.159	3928806.183	
28	499338.680	3928783.016	2.21				

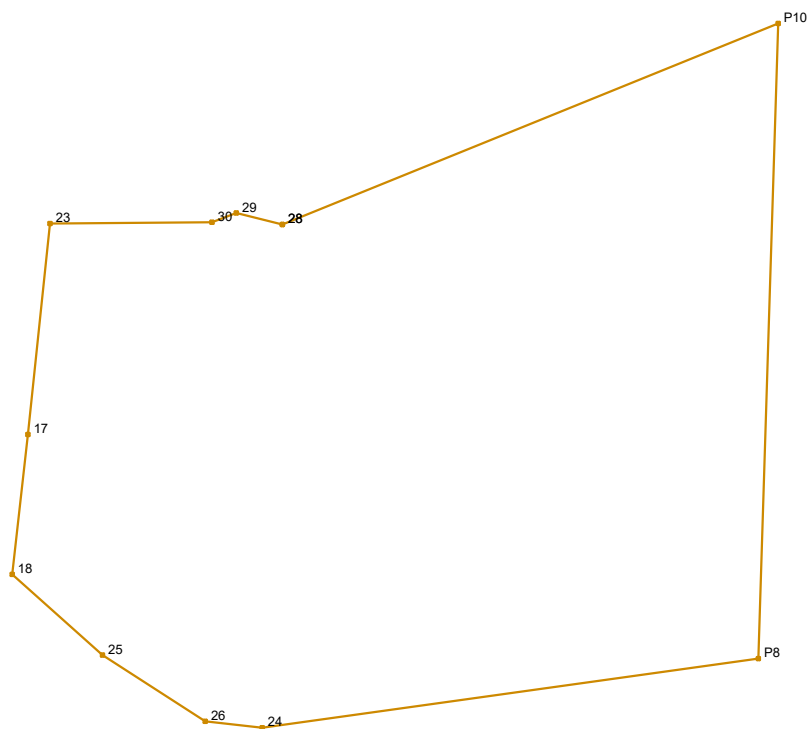

Νέα ιδιοκτησία εντός ΟΤ							
id1:1494		id2:07		Σημεία:11		Εμβαδό:842.47 m <sup>2</sup>	
Σημείο	X	Y	μήκος	Σημείο	X	Y	μήκος
28	499338.680	3928783.016		18	499326.131	3928766.758	
			24.87				6.54
P10	499361.727	3928792.373		17	499326.854	3928773.261	
			29.54				9.86
P8	499360.803	3928762.848		23	499327.875	3928783.070	
			23.28				7.53
24	499337.743	3928759.635		30	499335.405	3928783.129	
			2.66				1.22
26	499335.097	3928759.930		29	499336.543	3928783.563	
			5.69				2.21
25	499330.324	3928763.019		28	499338.680	3928783.016	
			5.62				



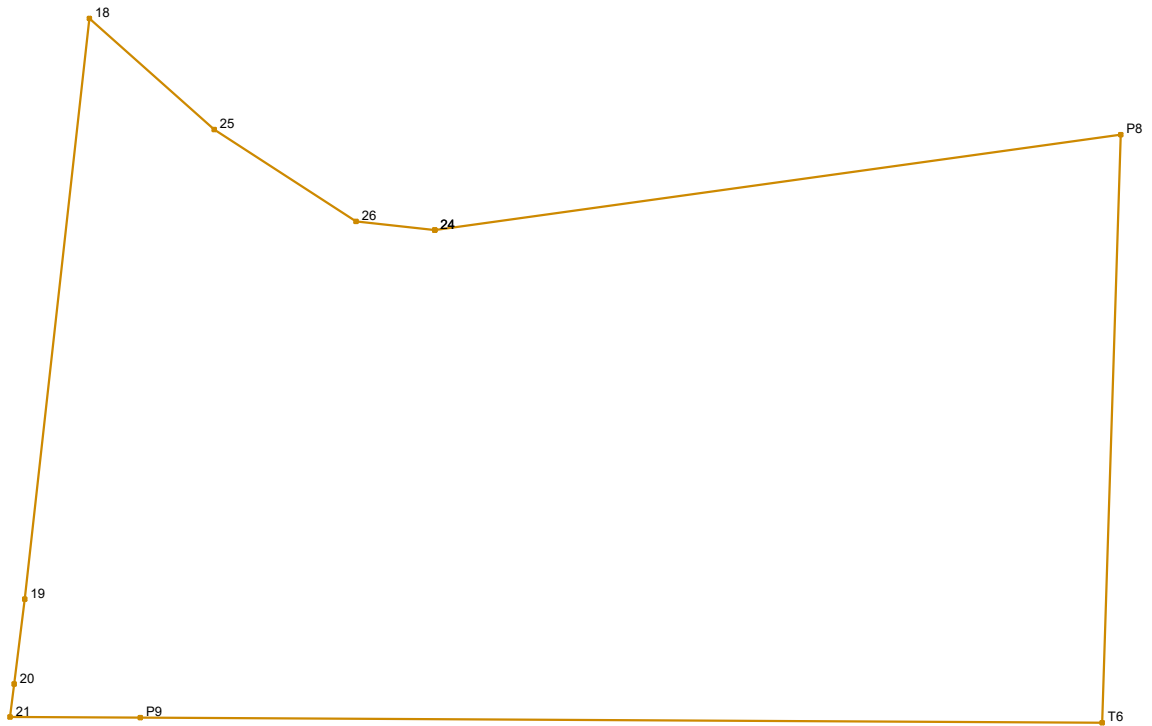

Νέα ιδιοκτησία εντός ΟΤ							
id1:1494		id2:08		Σημεία:10		Εμβαδό:664.07 m <sup>2</sup>	
Σημείο	X	Y	μήκος	Σημείο	X	Y	μήκος
24	499337.743	3928759.635	23.28	19	499323.960	3928747.228	19.65
P8	499360.803	3928762.848		19.78	18	499326.131	3928766.758
T6	499360.185	3928743.075	32.35	25	499330.324	3928763.019	5.69
P9	499327.839	3928743.245		4.38	26	499335.097	3928759.930
21	499323.458	3928743.268	1.11	24	499337.743	3928759.635	
20	499323.598	3928744.373		2.88			

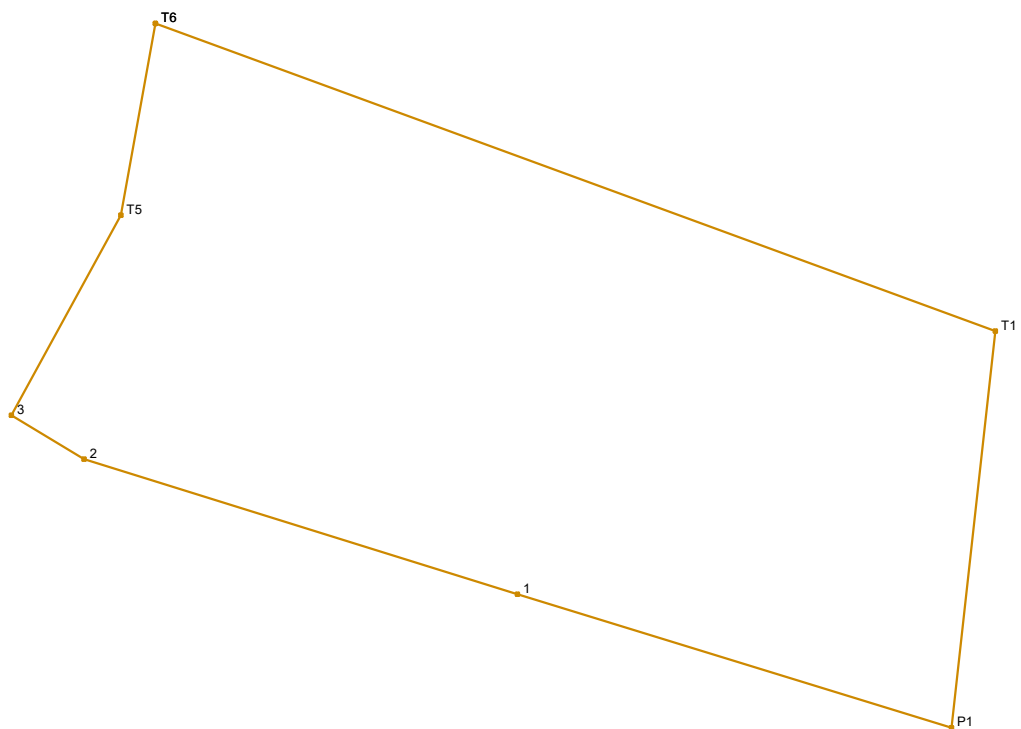

Νέα ιδιοκτησία εντός ΟΤ							
id1:1495		id2:01		Σημεία:7		Εμβαδό:956.73 m <sup>2</sup>	
Σημείο	X	Y	μήκος	Σημείο	X	Y	μήκος
T6	499304.007	3928875.801		2	499300.434	3928854.010	
			44.73				4.25
T1	499346.003	3928860.406		3	499296.795	3928856.208	
			19.95				11.39
P1	499343.804	3928840.579		T5	499302.269	3928866.201	
			22.70				9.76
1	499322.109	3928847.253		T6	499304.007	3928875.801	
			22.70				

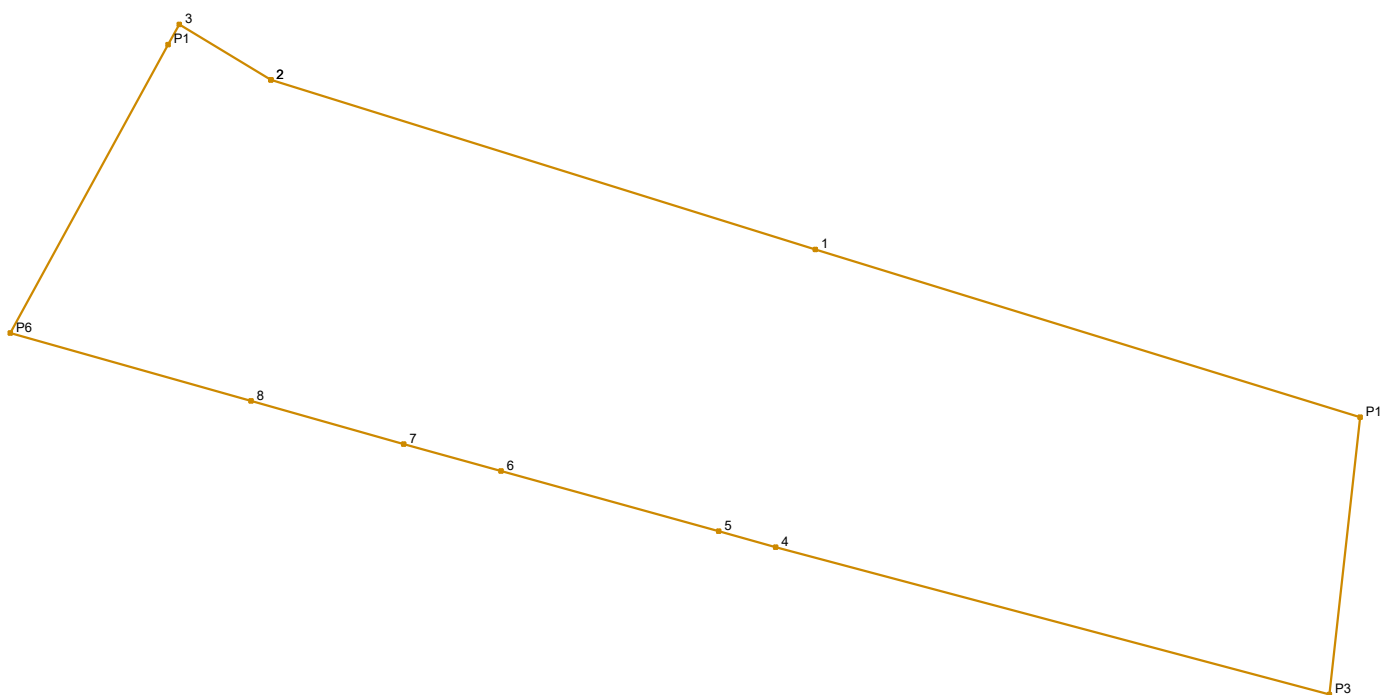

Νέα ιδιοκτησία εντός ΟΤ							
id1:1495		id2:02		Σημεία:12		Εμβαδό:620.84 m <sup>2</sup>	
Σημείο	X	Y	μήκος	Σημείο	X	Y	μήκος
2	499300.434	3928854.010		7	499305.729	3928839.502	
			22.70				6.32
1	499322.109	3928847.253		8	499299.645	3928841.222	
			22.70				9.95
P1	499343.804	3928840.579		P6	499290.068	3928843.929	
			11.11				13.08
P3	499342.579	3928829.540		P1	499296.354	3928855.403	
			22.81				0.92
4	499320.536	3928835.405		3	499296.795	3928856.208	
			2.36				4.25
5	499318.265	3928836.036		2	499300.434	3928854.010	
			8.99				
6	499309.599	3928838.443					
			4.01				

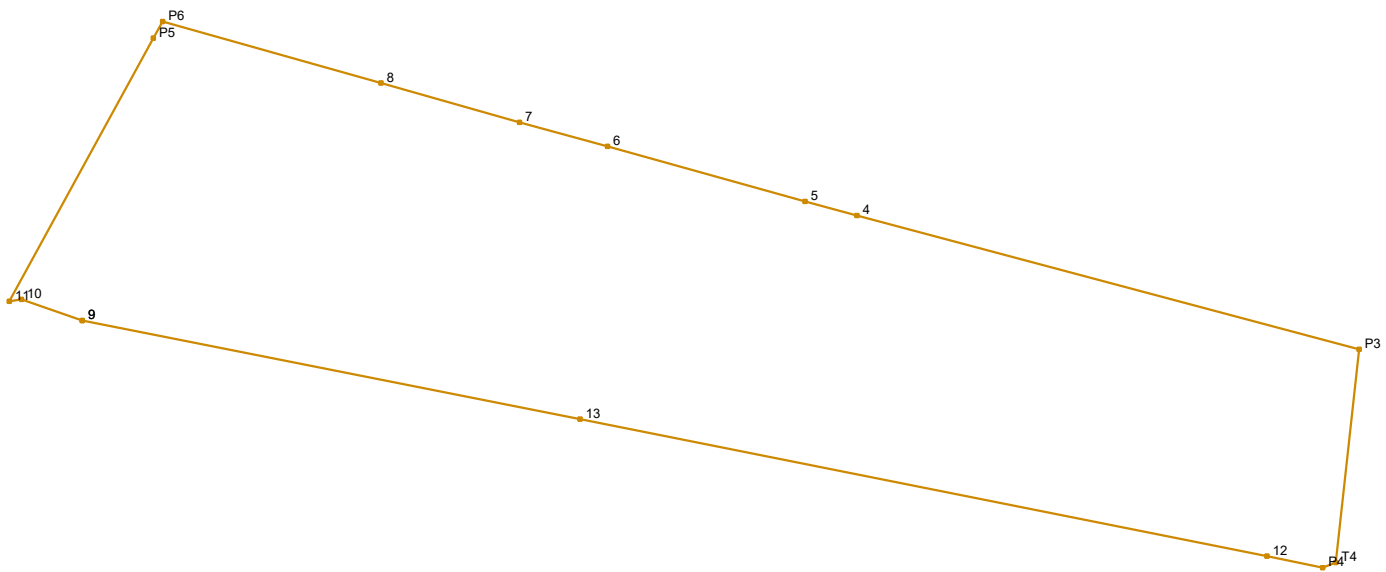

Νέα ιδιοκτησία εντός ΟΤ							
id1:1495		id2:03		Σημεία:15		Εμβαδό:657.88 m <sup>2</sup>	
Σημείο	X	Y	μήκος	Σημείο	X	Y	μήκος
9	499286.544	3928830.811		5	499318.265	3928836.036	
			2.82				2.36
10	499283.873	3928831.728		4	499320.536	3928835.405	
			0.54				22.81
11	499283.342	3928831.651		P3	499342.579	3928829.540	
			13.17				9.42
P5	499289.668	3928843.198		T4	499341.541	3928820.182	
			0.83				0.61
P6	499290.068	3928843.929		P4	499340.977	3928819.962	
			9.95				2.49
8	499299.645	3928841.222		12	499338.534	3928820.464	
			6.32				30.74
7	499305.729	3928839.502		13	499308.386	3928826.476	
			4.01				22.27
6	499309.599	3928838.443		9	499286.544	3928830.811	
			8.99				

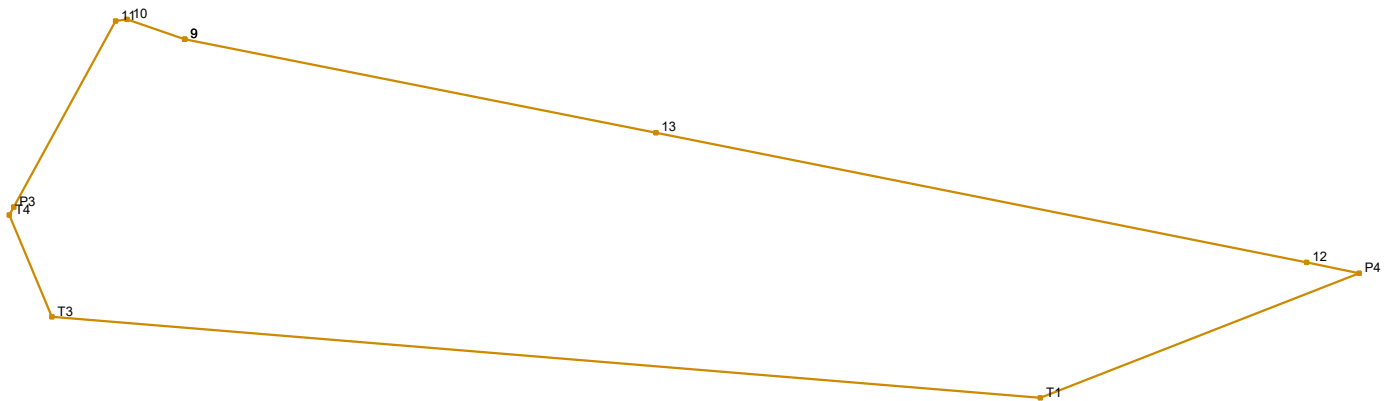

Νέα ιδιοκτησία εντός ΟΤ							
id1:1495		id2:04		Σημεία:10		Εμβαδό:587.84 m <sup>2</sup>	
Σημείο	X	Y	μήκος	Σημείο	X	Y	μήκος
9	499286.544	3928830.811	22.27	T4	499278.420	3928822.665	0.43
13	499308.386	3928826.476	30.74	P3	499278.625	3928823.040	9.82
12	499338.534	3928820.464	2.49	11	499283.342	3928831.651	0.54
P4	499340.977	3928819.962	15.87	10	499283.873	3928831.728	2.82
T1	499326.190	3928814.200	45.95	9	499286.544	3928830.811	
T3	499280.396	3928817.947	5.12				

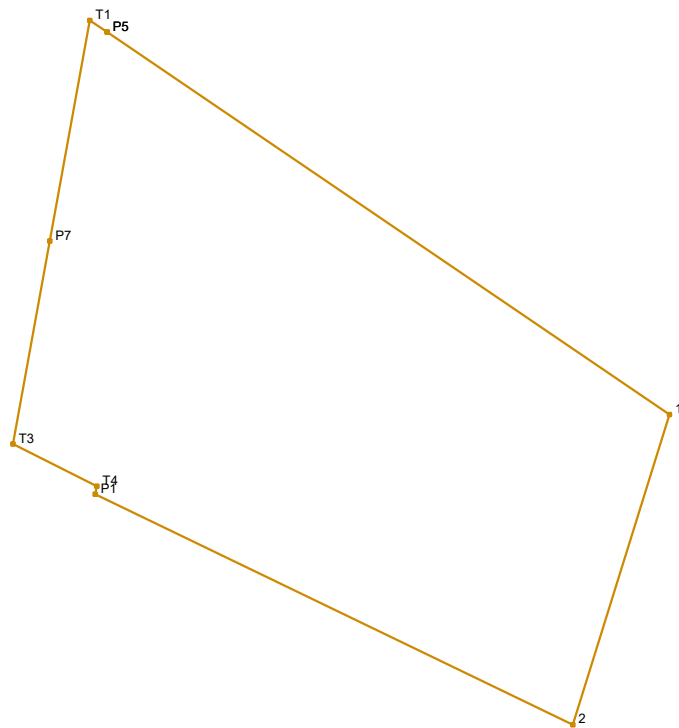

Νέα ιδιοκτησία εντός ΟΤ							
id1:1496		id2:01		Σημεία:8		Εμβαδό:1070.95 m <sup>2</sup>	
Σημείο	X	Y	μήκος	Σημείο	X	Y	μήκος
P5	499316.818	3928939.441		T3	499310.553	3928911.957	13.75
1	499354.364	3928913.917	45.40	P7	499313.002	3928925.484	14.98
2	499347.918	3928893.219	21.68	T1	499315.670	3928940.222	1.39
P1	499316.042	3928908.597	35.39	P5	499316.818	3928939.441	
T4	499316.138	3928909.127	0.54				
			6.26				

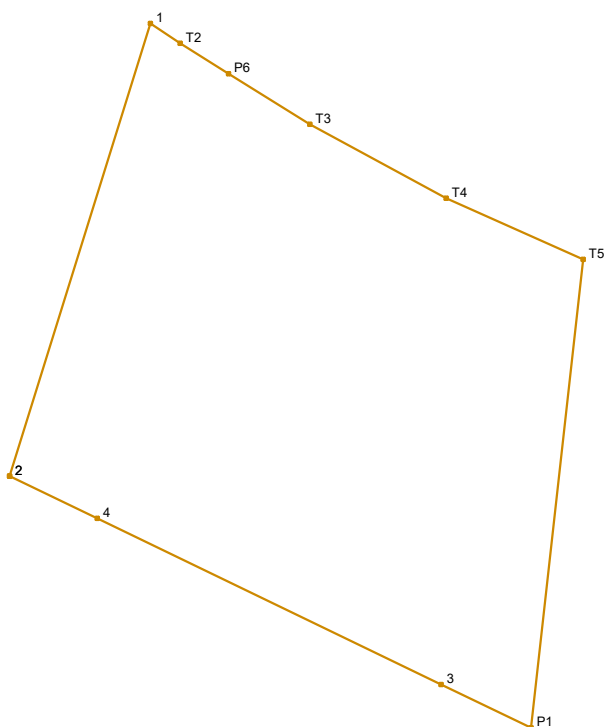

Νέα ιδιοκτησία εντός ΟΤ							
id1:1496		id2:02N		Σημεία:10		Εμβαδό:499.89 m <sup>2</sup>	
Σημείο	X	Y	μήκος	Σημείο	X	Y	μήκος
2	499347.918	3928893.219	21.68	T5	499374.144	3928903.129	21.54
1	499354.364	3928913.917	1.64	P1	499371.756	3928881.719	4.55
T2	499355.720	3928912.995	2.60	3	499367.654	3928883.698	17.46
P6	499357.926	3928911.619	4.39	4	499351.927	3928891.285	4.45
T3	499361.650	3928909.297	7.09	2	499347.918	3928893.219	
T4	499367.879	3928905.922	6.86				

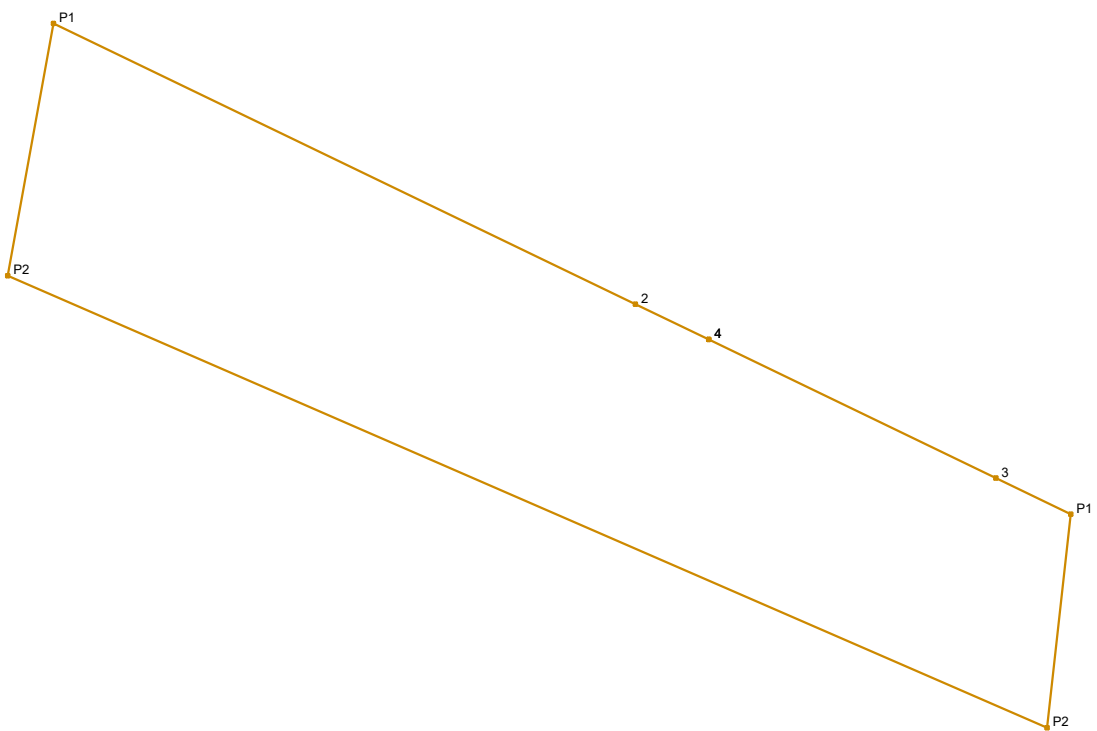

Νέα ιδιοκτησία εντός ΟΤ							
id1:1496		id2:03		Σημεία:7		Εμβαδό:767.53 m <sup>2</sup>	
Σημείο	X	Y	μήκος	Σημείο	X	Y	μήκος
4	499351.927	3928891.285	17.46	P2	499313.540	3928894.775	14.05
3	499367.654	3928883.698	4.55	P1	499316.042	3928908.597	35.39
P1	499371.756	3928881.719	11.77	2	499347.918	3928893.219	4.45
P2	499370.453	3928870.026	62.06	4	499351.927	3928891.285	



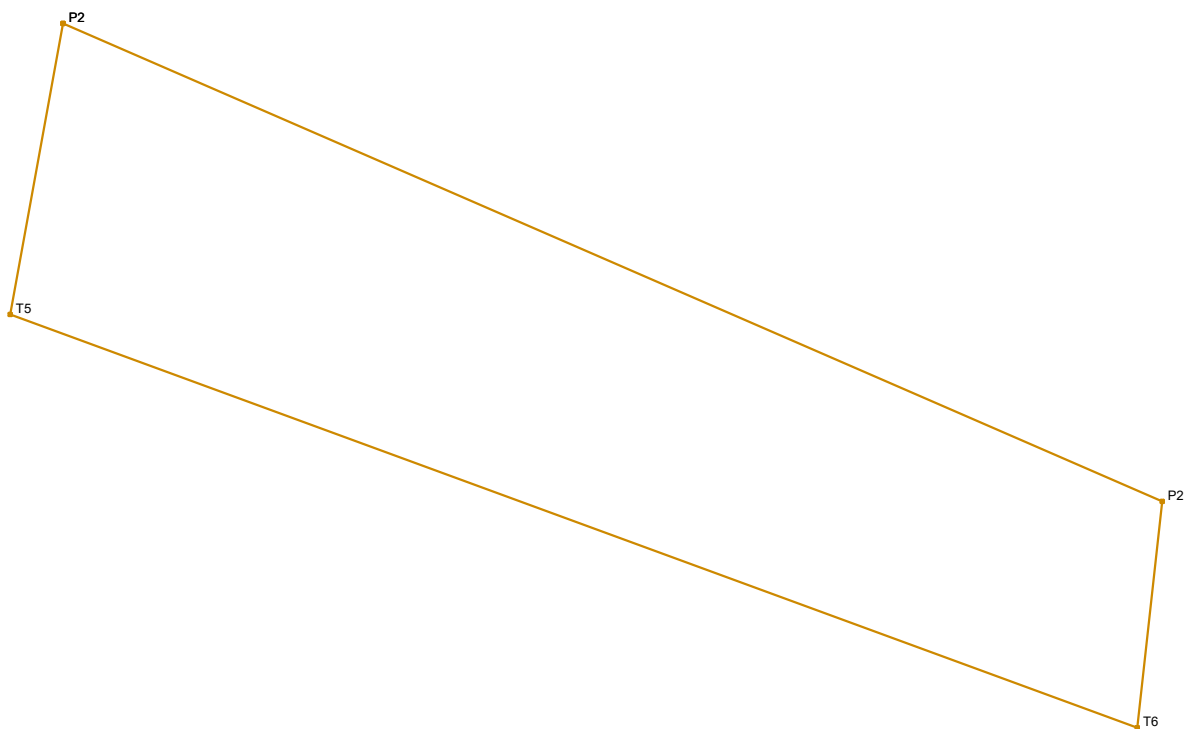

Νέα ιδιοκτησία εντός ΟΤ							
id1:1496		id2:04		Σημεία:4		Εμβαδό:818.46 m <sup>2</sup>	
Σημείο	X	Y	μήκος	Σημείο	X	Y	μήκος
P2	499313.540	3928894.775	62.06	T5	499310.810	3928879.698	15.32
P2	499370.453	3928870.026		11.79	P2	499313.540	
T6	499369.147	3928858.312	62.13				

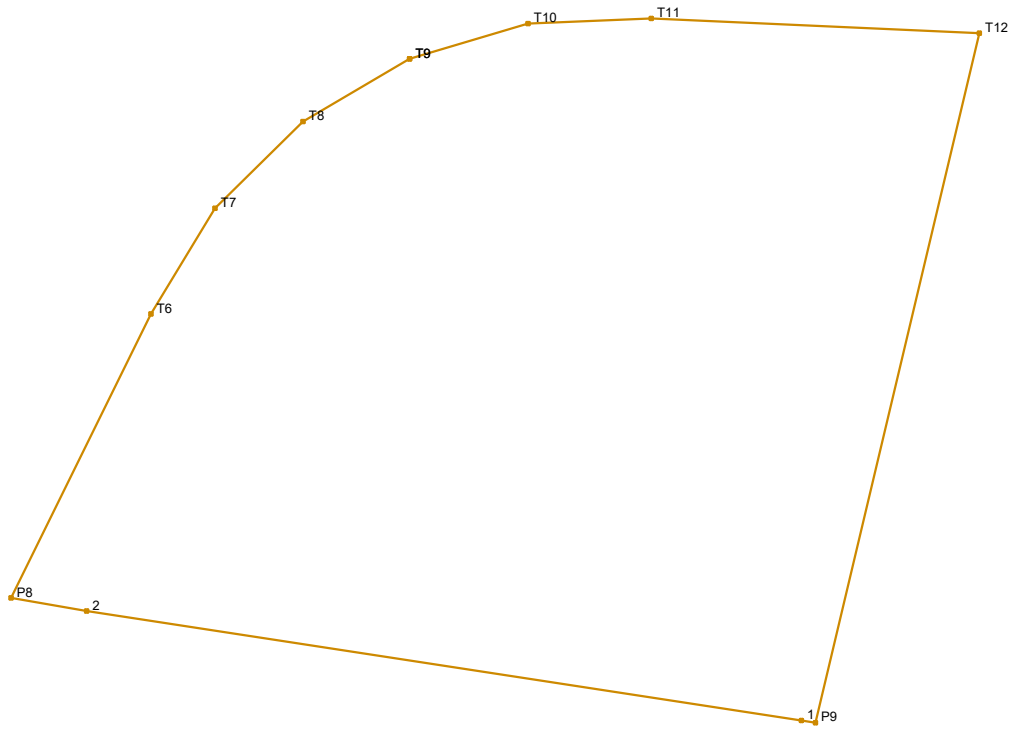

Νέα ιδιοκτησία εντός ΟΤ							
id1:1497		id2:01		Σημεία:11		Εμβαδό:508.87 m <sup>2</sup>	
Σημείο	X	Y	μήκος	Σημείο	X	Y	μήκος
T9	499246.146	3928808.991		2	499235.556	3928790.880	
			4.05				2.51
T10	499250.033	3928810.142		P8	499233.085	3928791.306	
			4.05				10.38
T11	499254.083	3928810.315		T6	499237.664	3928800.620	
			10.77				4.05
T12	499264.840	3928809.828		T7	499239.771	3928804.083	
			23.25				4.05
P9	499259.460	3928787.214		T8	499242.656	3928806.930	
			0.46				4.05
1	499259.002	3928787.284		T9	499246.146	3928808.991	
			23.72				

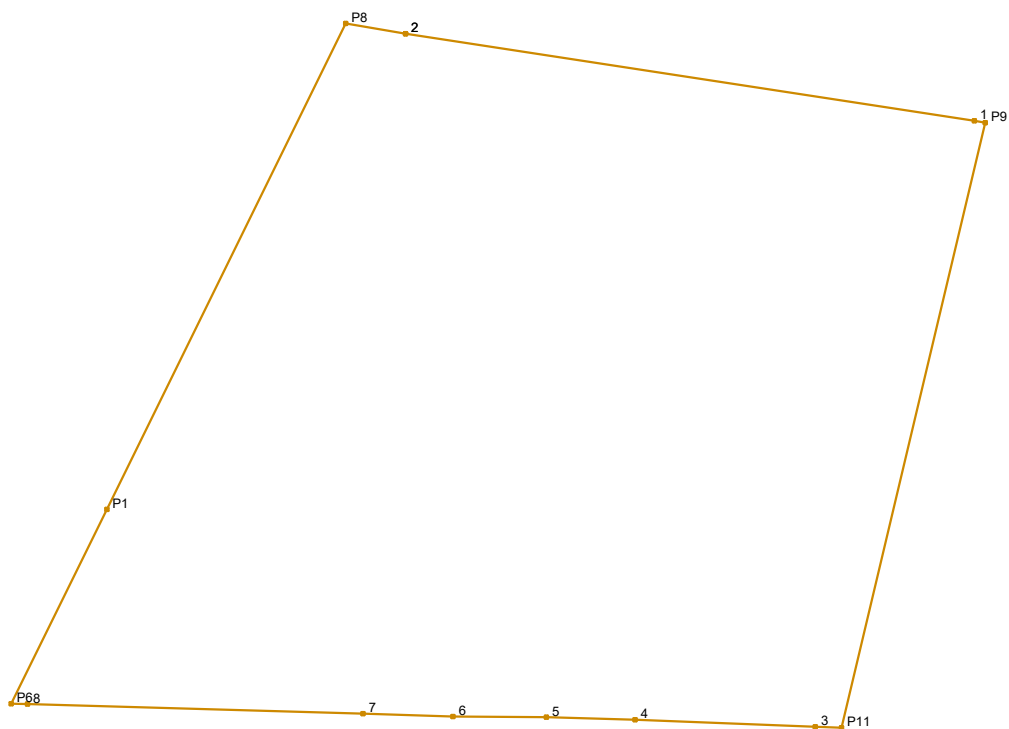

Νέα ιδιοκτησία εντός ΟΤ							
id1:1497		id2:02		Σημεία:13		Εμβαδό:826.81 m <sup>2</sup>	
Σημείο	X	Y	μήκος	Σημείο	X	Y	μήκος
2	499235.556	3928790.880	23.72	6	499237.501	3928762.726	3.71
1	499259.002	3928787.284	0.46	7	499233.796	3928762.836	13.83
P9	499259.460	3928787.214	25.65	8	499219.967	3928763.233	0.67
P11	499253.524	3928762.259	1.08	P6	499219.293	3928763.252	8.92
3	499252.444	3928762.301	7.44	P1	499223.230	3928771.260	22.34
4	499245.014	3928762.590	3.66	P8	499233.085	3928791.306	2.51
5	499241.360	3928762.694	3.86	2	499235.556	3928790.880	

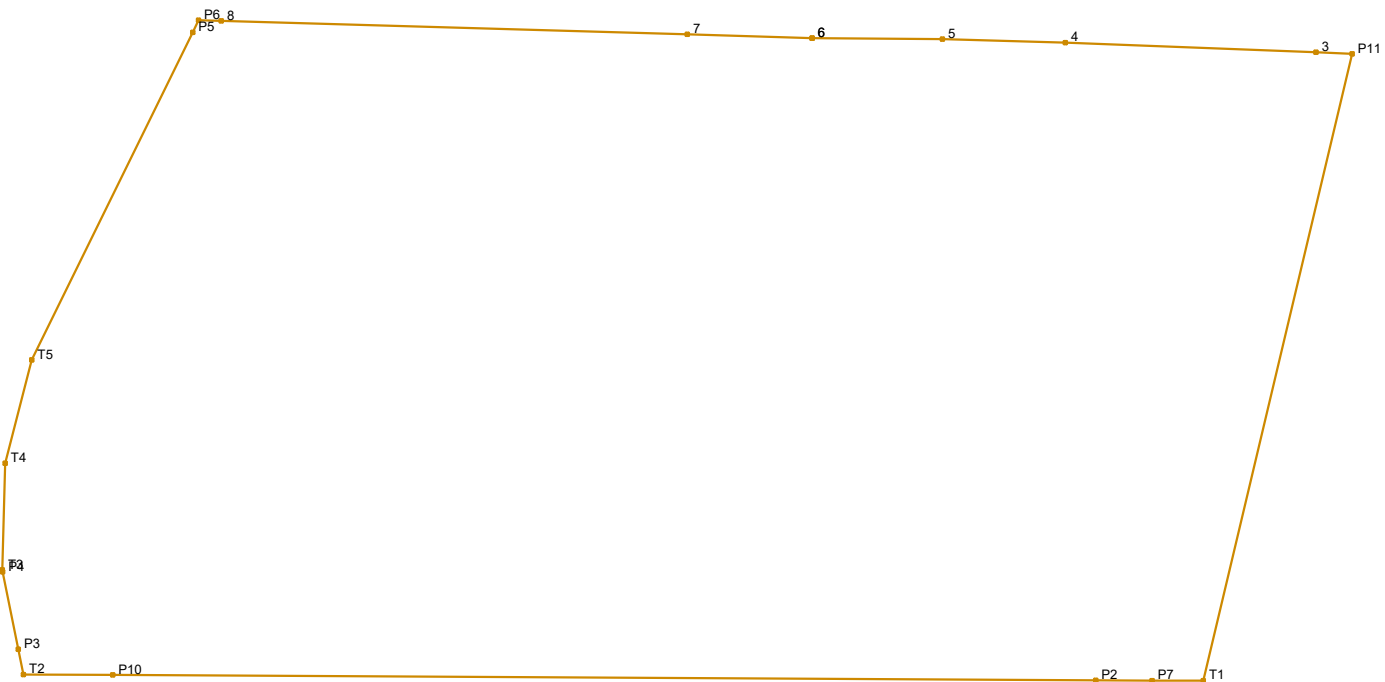

Νέα ιδιοκτησία εντός ΟΤ							
id1:1497		id2:03		Σημεία:19		Εμβαδό:687.97 m <sup>2</sup>	
Σημείο	X	Y	μήκος	Σημείο	X	Y	μήκος
6	499237.501	3928762.726	3.86	P3	499213.946	3928744.591	2.34
5	499241.360	3928762.694		P4	499213.481	3928746.887	0.06
4	499245.014	3928762.590	3.66	T3	499213.469	3928746.944	3.17
3	499252.444	3928762.301	7.44	T4	499213.551	3928750.110	3.17
P11	499253.524	3928762.259	1.08	T5	499214.339	3928753.176	10.83
T1	499249.099	3928743.657	19.12	P5	499219.117	3928762.894	0.40
P7	499247.583	3928743.665	1.52	P6	499219.293	3928763.252	0.67
P2	499245.907	3928743.674	1.68	8	499219.967	3928763.233	13.83
P10	499216.744	3928743.827	29.16	7	499233.796	3928762.836	3.71
T2	499214.098	3928743.841	2.65	6	499237.501	3928762.726	
			0.77				

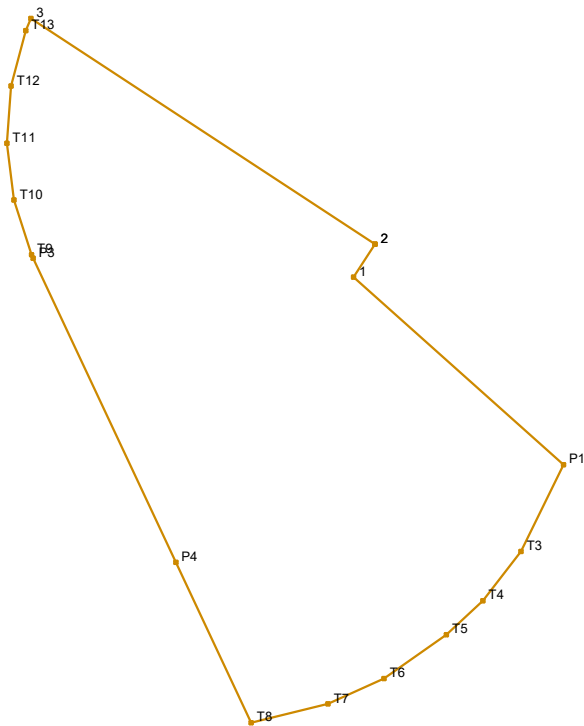

Νέα ιδιοκτησία εντός ΟΤ							
id1:1498		id2:01		Σημεία:17		Εμβαδό:693.39 m <sup>2</sup>	
Σημείο	X	Y	μήκος	Σημείο	X	Y	μήκος
2	499191.833	3928766.154		P4	499179.925	3928747.142	20.06
1	499190.543	3928764.185	2.35	P3	499171.403	3928765.304	0.23
P1	499203.098	3928752.977	16.83	T9	499171.304	3928765.516	3.43
T3	499200.550	3928747.795	5.77	T10	499170.252	3928768.776	3.43
T4	499198.265	3928744.843	3.73	T11	499169.839	3928772.177	3.43
T5	499196.084	3928742.815	2.98	T12	499170.081	3928775.594	3.43
T6	499192.365	3928740.207	4.54	T13	499170.968	3928778.903	0.79
T7	499189.019	3928738.696	3.67	3	499171.266	3928779.635	24.59
T8	499184.420	3928737.561	4.74	2	499191.833	3928766.154	
			10.58				

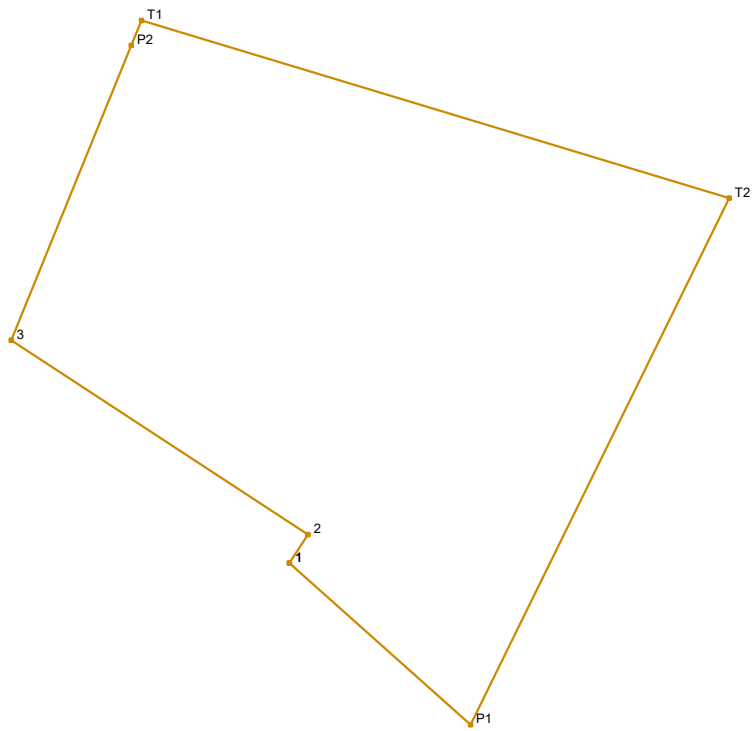

Νέα ιδιοκτησία εντός ΟΤ							
id1:1498		id2:02		Σημεία:7		Εμβαδό:1287.28 m <sup>2</sup>	
Σημείο	X	Y	μήκος	Σημείο	X	Y	μήκος
1	499190.543	3928764.185	2.35	T1	499180.304	3928801.804	42.56
2	499191.833	3928766.154	24.59	T2	499221.040	3928789.472	40.67
3	499171.266	3928779.635	22.05	P1	499203.098	3928752.977	16.83
P2	499179.591	3928800.055	1.89	1	499190.543	3928764.185	

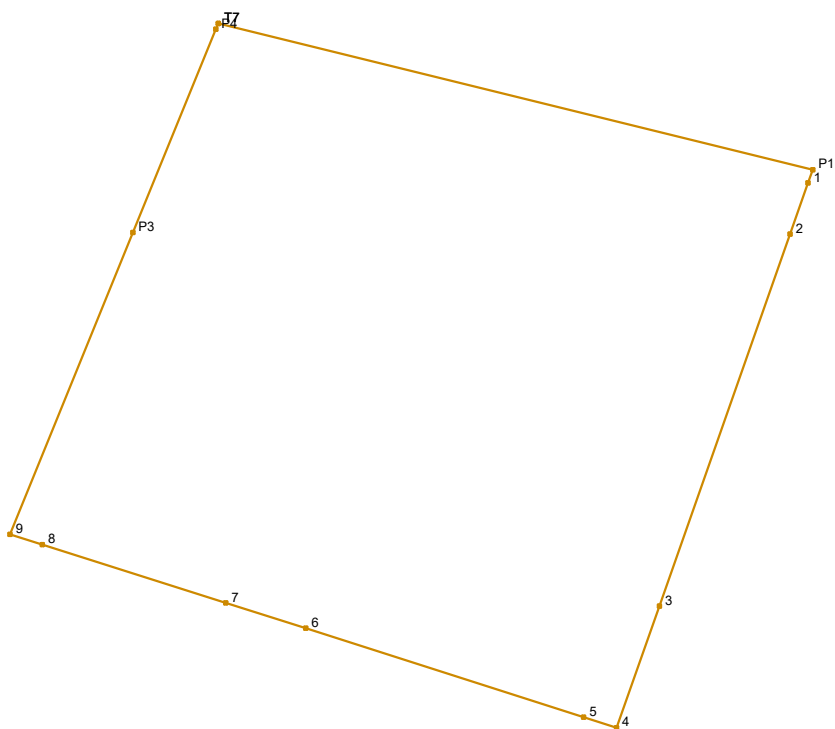

Νέα ιδιοκτησία εντός ΟΤ							
id1:1499		id2:01		Σημεία:13		Εμβαδό:297.71 m <sup>2</sup>	
Σημείο	X	Y	μήκος	Σημείο	X	Y	μήκος
T7	499202.854	3928857.118	17.72	6	499205.386	3928839.610	2.43
P1	499220.060	3928852.882		0.41	7	499203.065	3928840.338
1	499219.924	3928852.495	1.57	8	499197.758	3928842.025	0.98
2	499219.405	3928851.017	11.41	9	499196.822	3928842.323	9.44
3	499215.622	3928840.251	3.74	P3	499200.385	3928851.063	6.36
4	499214.383	3928836.725	1.00	P4	499202.785	3928856.949	0.18
5	499213.430	3928837.029	8.45	T7	499202.854	3928857.118	

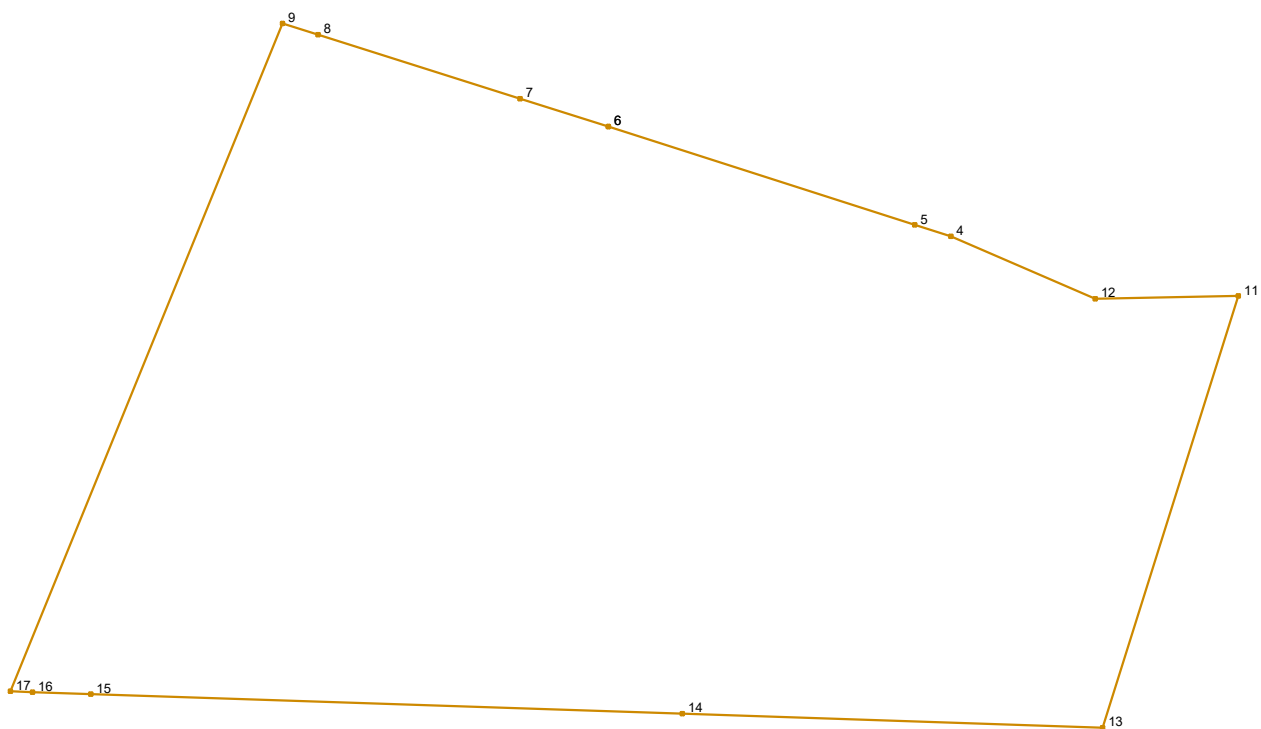

Νέα ιδιοκτησία εντός ΟΤ							
id1:1499		id2:02		Σημεία:13		Εμβαδό:400.00 m <sup>2</sup>	
Σημείο	X	Y	μήκος	Σημείο	X	Y	μήκος
6	499205.386	3928839.610	8.45	15	499191.781	3928824.702	1.53
5	499213.430	3928837.029	1.00	16	499190.252	3928824.753	0.58
4	499214.383	3928836.725	4.13	17	499189.667	3928824.772	18.95
12	499218.173	3928835.083	3.76	9	499196.822	3928842.323	0.98
11	499221.935	3928835.161	11.89	8	499197.758	3928842.025	5.57
13	499218.370	3928823.815	11.05	7	499203.065	3928840.338	2.43
14	499207.322	3928824.183	15.55	6	499205.386	3928839.610	



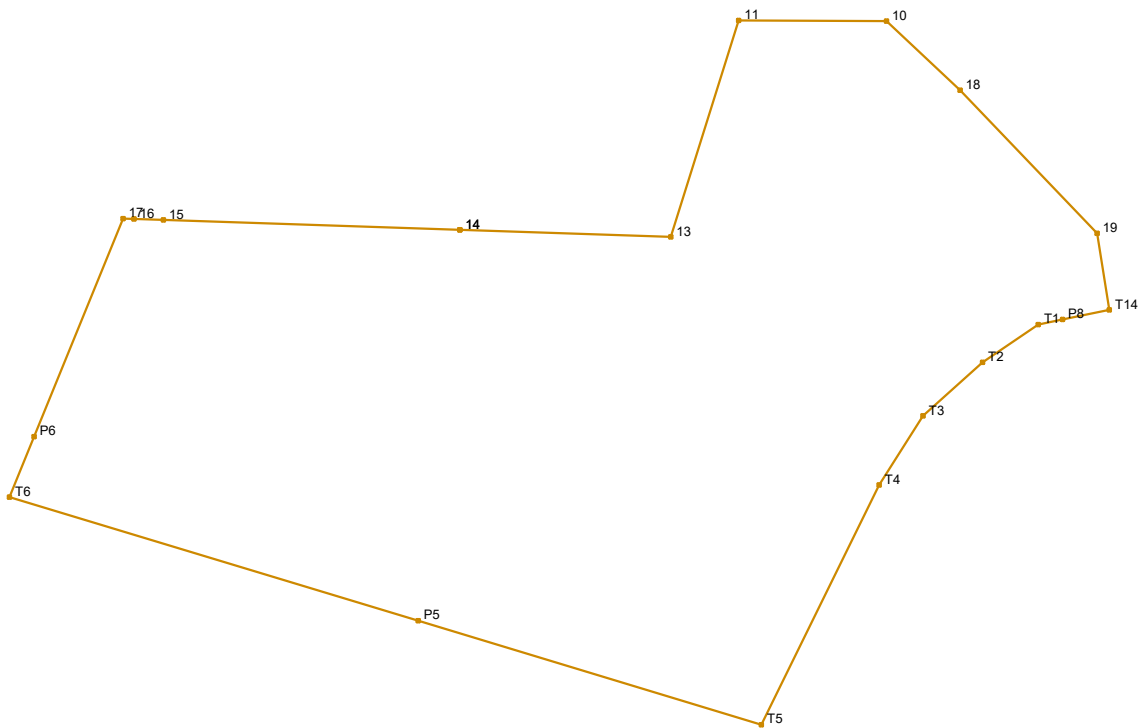

Νέα ιδιοκτησία εντός ΟΤ							
ιδ1:1499		ιδ2:03		Σημεία:19		Εμβαδό:1122.10 m <sup>2</sup>	
Σημείο	X	Y	μήκος	Σημείο	X	Y	μήκος
14	499207.322	3928824.183	11.05	T3	499231.591	3928814.442	4.29
13	499218.370	3928823.815		T4	499229.301	3928810.808	14.00
11	499221.935	3928835.161	7.75	T5	499223.124	3928798.244	18.79
10	499229.686	3928835.114	5.29	P5	499205.137	3928803.689	22.38
18	499233.546	3928831.502	10.38	T6	499183.716	3928810.174	3.43
19	499240.724	3928824.000	4.06	P6	499185.011	3928813.350	12.34
T14	499241.356	3928819.994	2.49	17	499189.667	3928824.772	0.58
P8	499238.920	3928819.479	1.31	16	499190.252	3928824.753	1.53
T1	499237.634	3928819.207	3.52	15	499191.781	3928824.702	15.55
T2	499234.725	3928817.231	4.20	14	499207.322	3928824.183	

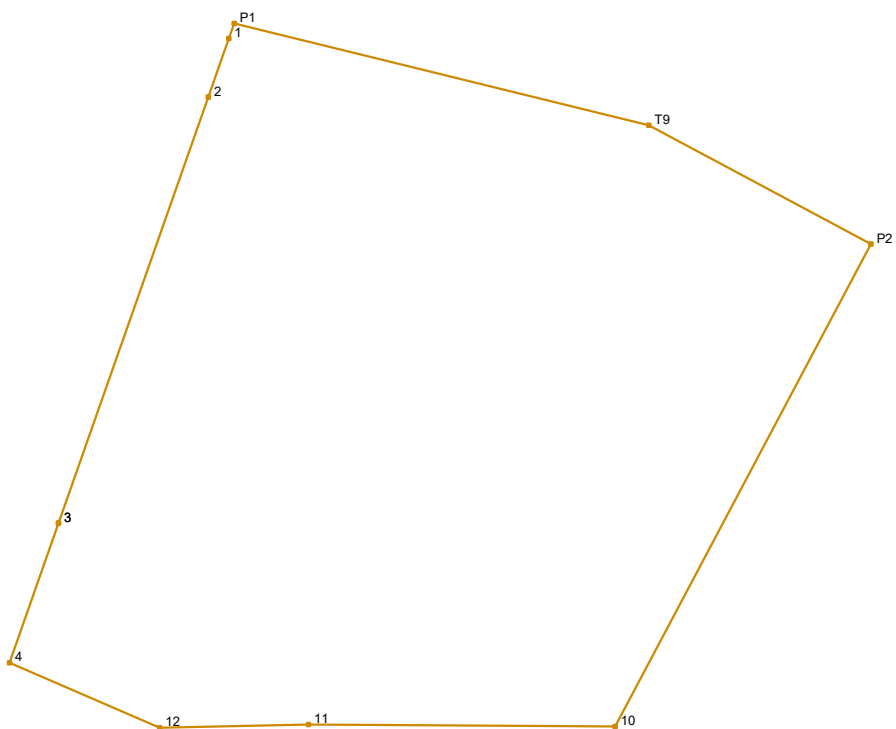

Νέα ιδιοκτησία εντός ΟΤ							
id1:1499		id2:04		Σημεία:10		Εμβαδό:261.86 m <sup>2</sup>	
Σημείο	X	Y	μήκος	Σημείο	X	Y	μήκος
3	499215.622	3928840.251	11.41	10	499229.686	3928835.114	7.75
2	499219.405	3928851.017	1.57	11	499221.935	3928835.161	3.76
1	499219.924	3928852.495	0.41	12	499218.173	3928835.083	4.13
P1	499220.060	3928852.882	10.79	4	499214.383	3928836.725	3.74
T9	499230.533	3928850.304	6.36	3	499215.622	3928840.251	
P2	499236.148	3928847.309	13.80				

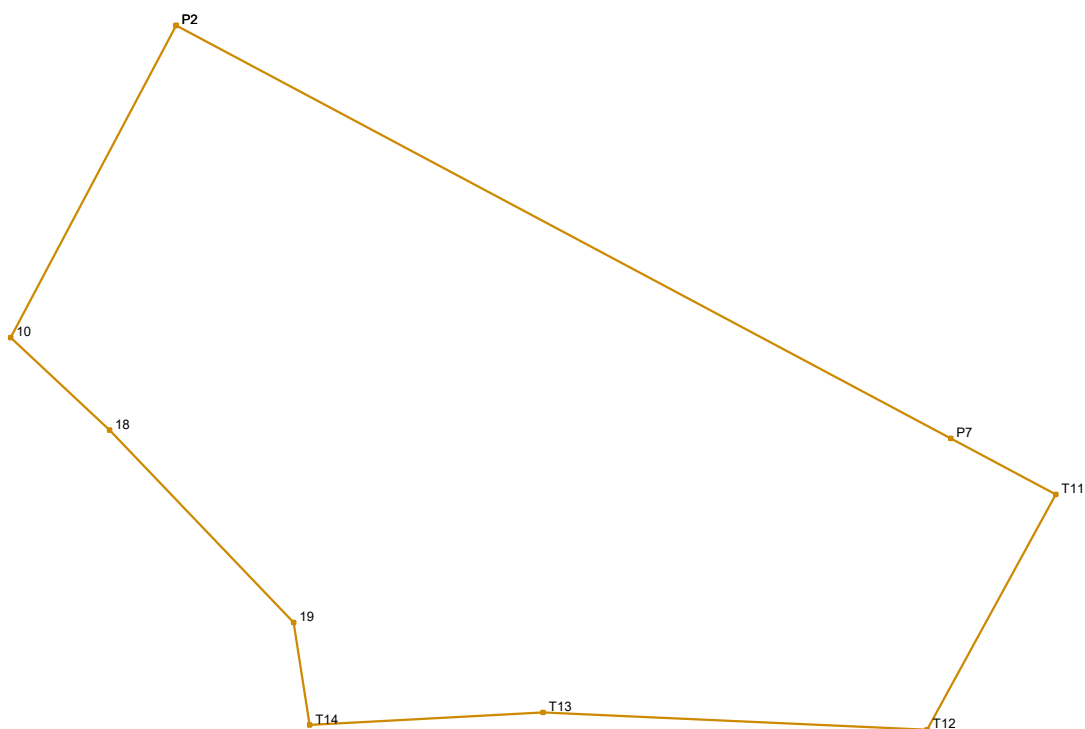

Νέα ιδιοκτησία εντός ΟΤ							
id1:1499		id2:05		Σημεία:9		Εμβαδό:625.52 m <sup>2</sup>	
Σημείο	X	Y	μήκος	Σημείο	X	Y	μήκος
P2	499236.148	3928847.309	34.26	T14	499241.356	3928819.994	4.06
P7	499266.380	3928831.185		4.65	19	499240.724	3928824.000
T11	499270.486	3928828.996	10.47	18	499233.546	3928831.502	5.29
T12	499265.454	3928819.810	15.00	10	499229.686	3928835.114	13.80
T13	499250.469	3928820.488		9.13	P2	499236.148	

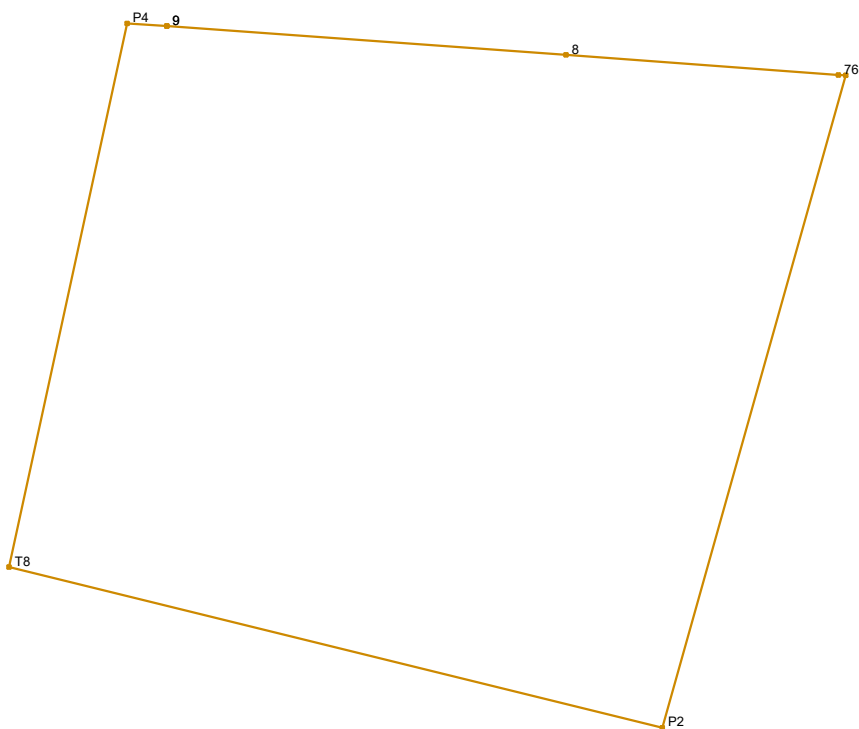

Νέα ιδιοκτησία εντός ΟΤ							
id1:1500		id2:01		Σημεία:7		Εμβαδό:304.73 m <sup>2</sup>	
Σημείο	X	Y	μήκος	Σημείο	X	Y	μήκος
9	499208.293	3928876.424	10.71	P2	499221.544	3928857.666	17.99
8	499218.974	3928875.654		T8	499204.077	3928861.966	14.87
7	499226.256	3928875.118	7.30	P4	499207.232	3928876.501	1.06
6	499226.447	3928875.107	0.19	9	499208.293	3928876.424	
			18.12				

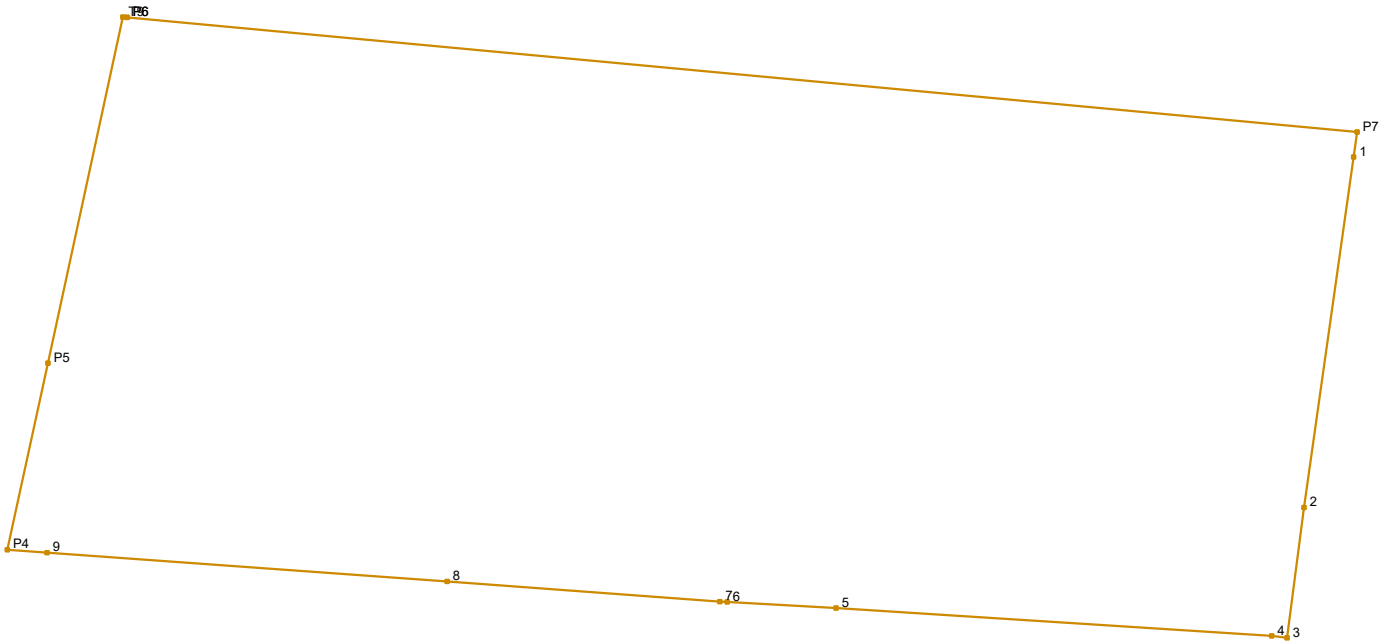

Νέα ιδιοκτησία εντός ΟΤ							
id1:1500		id2:02		Σημεία:14		Εμβαδό:472.50 m <sup>2</sup>	
Σημείο	X	Y	μήκος	Σημείο	X	Y	μήκος
P6	499210.430	3928890.711	32.98	7	499226.256	3928875.118	7.30
P7	499243.270	3928887.655		8	499218.974	3928875.654	10.71
1	499243.171	3928886.990	0.67	9	499208.293	3928876.424	1.06
2	499241.851	3928877.635	9.45	P4	499207.232	3928876.501	5.10
3	499241.392	3928874.149	3.52	P5	499208.313	3928881.483	9.45
4	499240.985	3928874.208	0.41	T9	499210.319	3928890.721	0.11
5	499229.351	3928874.948	11.66	P6	499210.430	3928890.711	
6	499226.447	3928875.107	2.91				
			0.19				

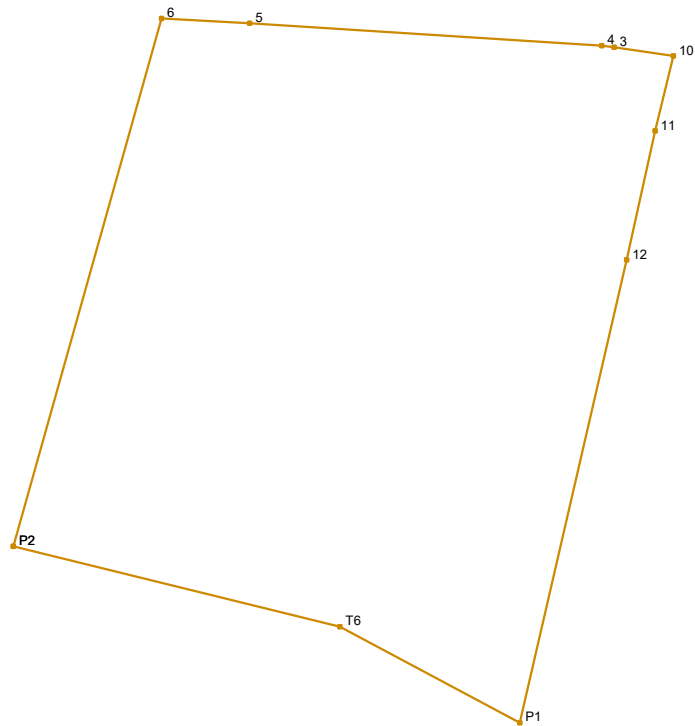

Νέα ιδιοκτησία εντός ΟΤ							
id1:1500		id2:03		Σημεία:10		Εμβαδό:341.86 m <sup>2</sup>	
Σημείο	X	Y	μήκος	Σημείο	X	Y	μήκος
P2	499221.544	3928857.666	18.12	11	499242.751	3928871.394	4.37
6	499226.447	3928875.107	2.91	12	499241.810	3928867.127	15.69
5	499229.351	3928874.948	11.66	P1	499238.274	3928851.842	6.73
4	499240.985	3928874.208	0.41	T6	499232.335	3928855.009	11.11
3	499241.392	3928874.149	1.98	P2	499221.544	3928857.666	
10	499243.346	3928873.865	2.54				

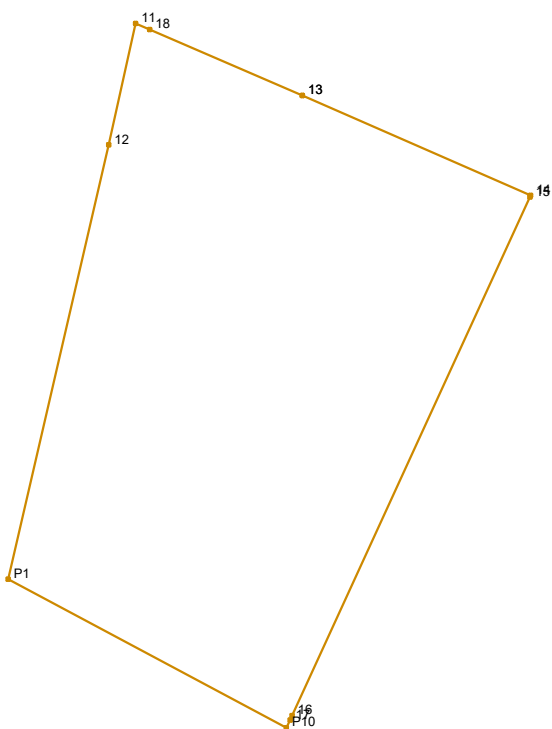

Νέα ιδιοκτησία εντός ΟΤ							
id1:1500		id2:04		Σημεία:10		Εμβαδό:263.13 m <sup>2</sup>	
Σημείο	X	Y	μήκος	Σημείο	X	Y	μήκος
13	499248.621	3928868.857	8.76	P1	499238.274	3928851.842	15.69
14	499256.641	3928865.338	0.05	12	499241.810	3928867.127	4.37
15	499256.621	3928865.292	20.06	11	499242.751	3928871.394	0.54
16	499248.259	3928847.054	0.17	18	499243.250	3928871.176	5.85
17	499248.187	3928846.898	0.30	13	499248.621	3928868.857	
P10	499248.061	3928846.622	11.09				

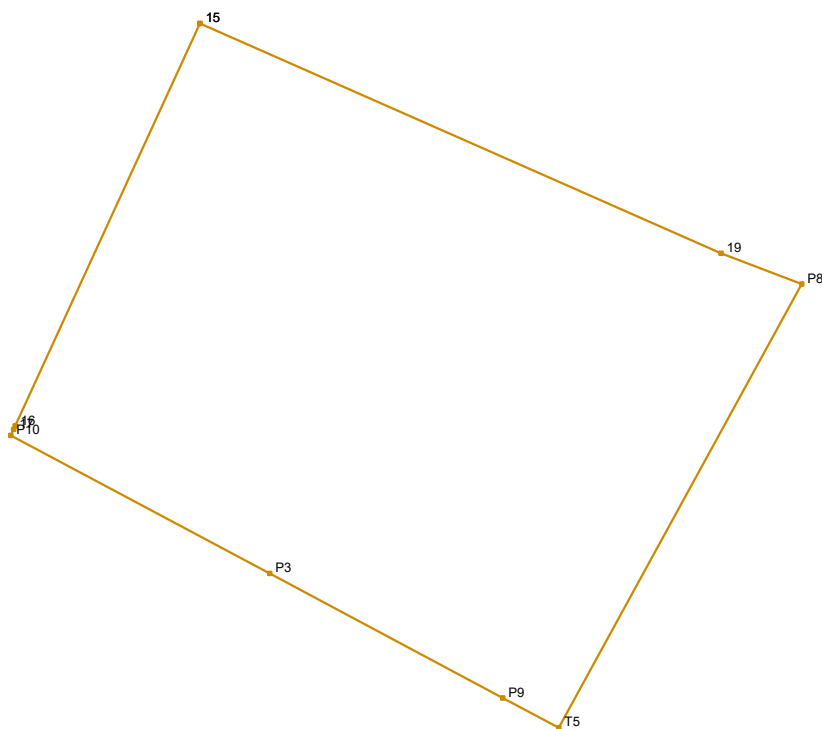

Νέα ιδιοκτησία εντός ΟΤ							
id1:1500		id2:05		Σημεία:9		Εμβαδό:624.99 m <sup>2</sup>	
Σημείο	X	Y	μήκος	Σημείο	X	Y	μήκος
15	499256.621	3928865.292	25.82	P3	499259.795	3928840.364	13.30
19	499280.243	3928854.874		3.91	P10	499248.061	3928846.622
P8	499283.895	3928853.474	22.91	17	499248.187	3928846.898	0.17
T5	499272.888	3928833.381	2.88	16	499248.259	3928847.054	20.06
P9	499270.349	3928834.735	11.96	15	499256.621	3928865.292	



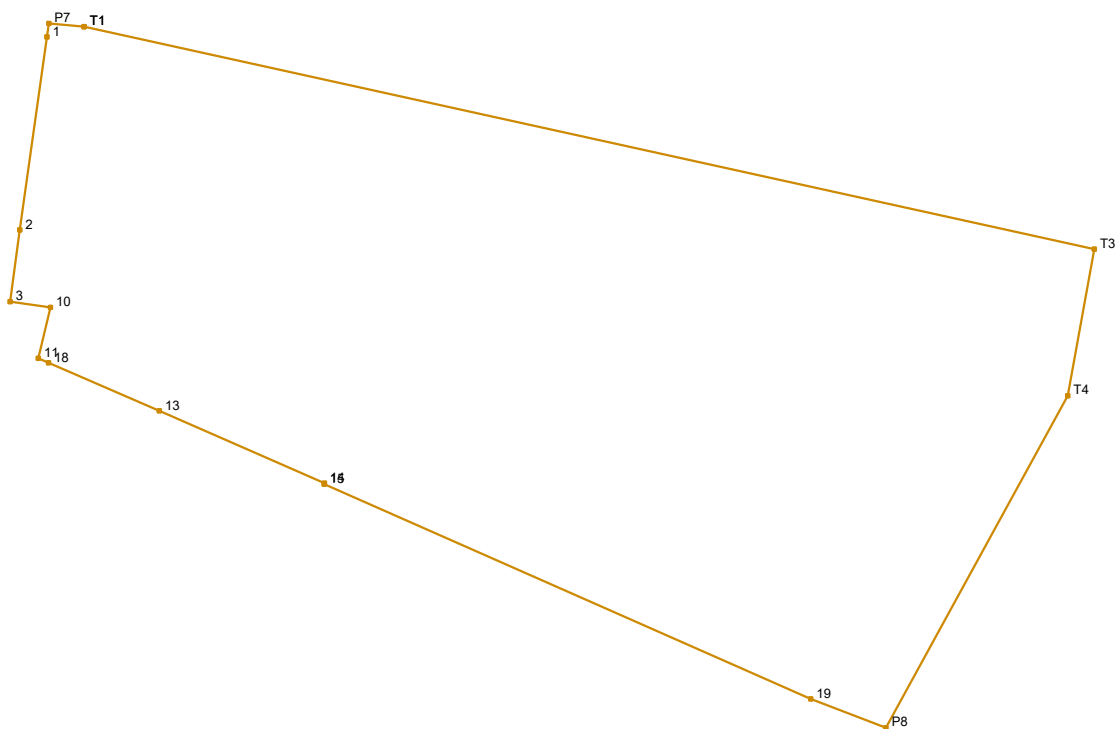

Νέα ιδιοκτησία εντός ΟΤ							
ιδ1:1500		ιδ2:06		Σημεία:15		Εμβαδό:1022.60 m <sup>2</sup>	
Σημείο	X	Y	μήκος	Σημείο	X	Y	μήκος
T1	499244.979	3928887.496	50.20	18	499243.250	3928871.176	0.54
T3	499294.006	3928876.692		11	499242.751	3928871.394	
T4	499292.719	3928869.581	7.23	10	499243.346	3928873.865	1.98
P8	499283.895	3928853.474	18.37	3	499241.392	3928874.149	
19	499280.243	3928854.874	3.91	2	499241.851	3928877.635	9.45
15	499256.621	3928865.292	25.82	1	499243.171	3928886.990	
14	499256.641	3928865.338	0.05	P7	499243.270	3928887.655	1.72
13	499248.621	3928868.857	8.76	T1	499244.979	3928887.496	
			5.85				

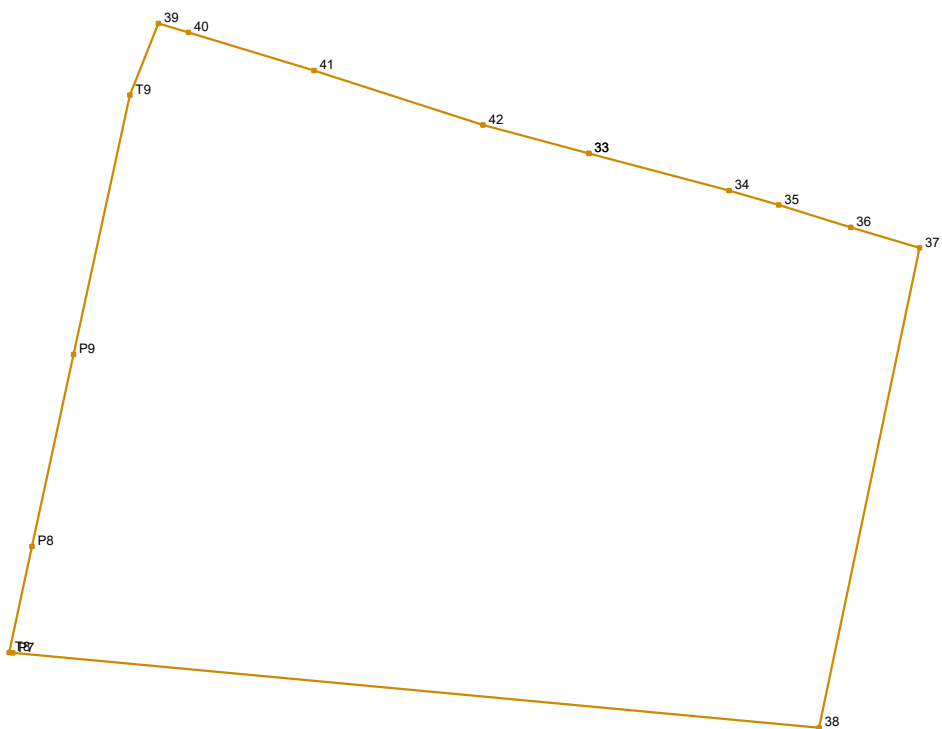

Νέα ιδιοκτησία εντός ΟΤ							
id1:1502		id2:01		Σημεία:15		Εμβαδό:647.89 m <sup>2</sup>	
Σημείο	X	Y	μήκος	Σημείο	X	Y	μήκος
33	499233.445	3928915.424	5.46	P8	499212.465	3928900.610	7.41
34	499238.727	3928914.021		P9	499214.036	3928907.847	10.00
35	499240.598	3928913.475	1.95	T9	499216.156	3928917.615	2.91
36	499243.307	3928912.632	2.84	39	499217.228	3928920.322	1.18
37	499245.898	3928911.869	2.70	40	499218.359	3928919.978	4.94
38	499242.110	3928893.789	18.47	41	499223.083	3928918.541	6.69
P7	499211.742	3928896.614	30.50	42	499229.449	3928916.494	4.14
T8	499211.601	3928896.628	0.14	33	499233.445	3928915.424	4.08
			4.08				

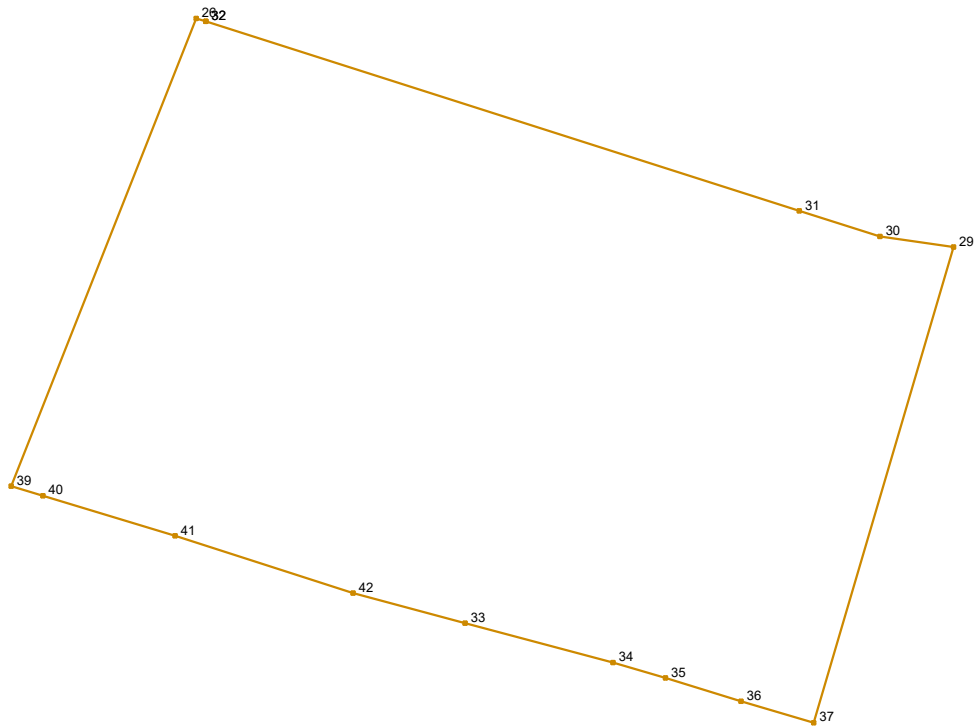

Νέα ιδιοκτησία εντός ΟΤ							
id1:1502		id2:02		Σημεία:14		Εμβαδό:513.79 m <sup>2</sup>	
Σημείο	X	Y	μήκος	Σημείο	X	Y	μήκος
32	499224.187	3928936.919	22.25	33	499233.445	3928915.424	4.14
31	499245.382	3928930.152		3.02	42	499229.449	3928916.494
30	499248.262	3928929.233	2.66	41	499223.083	3928918.541	4.94
29	499250.894	3928928.864	17.71	40	499218.359	3928919.978	1.18
37	499245.898	3928911.869	2.70	39	499217.228	3928920.322	17.97
36	499243.307	3928912.632	2.84	26	499223.841	3928937.030	0.36
35	499240.598	3928913.475	1.95	32	499224.187	3928936.919	
34	499238.727	3928914.021	5.46				

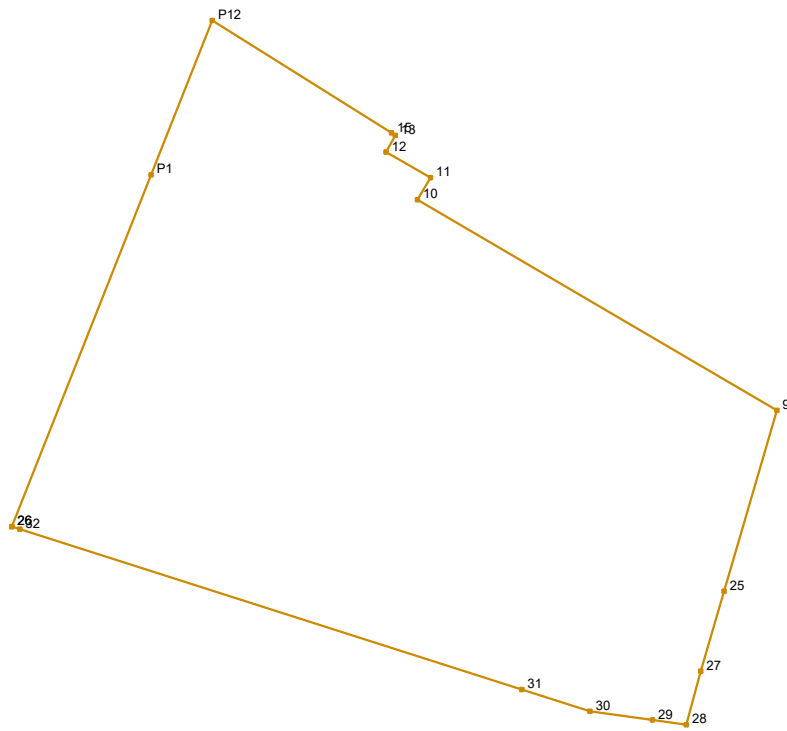

Νέα ιδιοκτησία εντός ΟΤ							
id1:1502		id2:03		Σημεία:16		Εμβαδό:527.89 m <sup>2</sup>	
Σημείο	X	Y	μήκος	Σημείο	X	Y	μήκος
26	499223.841	3928937.030	15.97	25	499253.919	3928934.298	3.51
P1	499229.719	3928951.882		7.01	27	499252.935	3928930.924
P12	499232.301	3928958.405	8.95	28	499252.329	3928928.664	1.45
15	499239.882	3928953.651	0.19	29	499250.894	3928928.864	2.66
13	499240.040	3928953.550	0.81	30	499248.262	3928929.233	3.02
12	499239.640	3928952.840	2.17	31	499245.382	3928930.152	22.25
11	499241.520	3928951.760	1.07	32	499224.187	3928936.919	0.36
10	499240.977	3928950.834	17.58	26	499223.841	3928937.030	
9	499256.147	3928941.940	7.96				

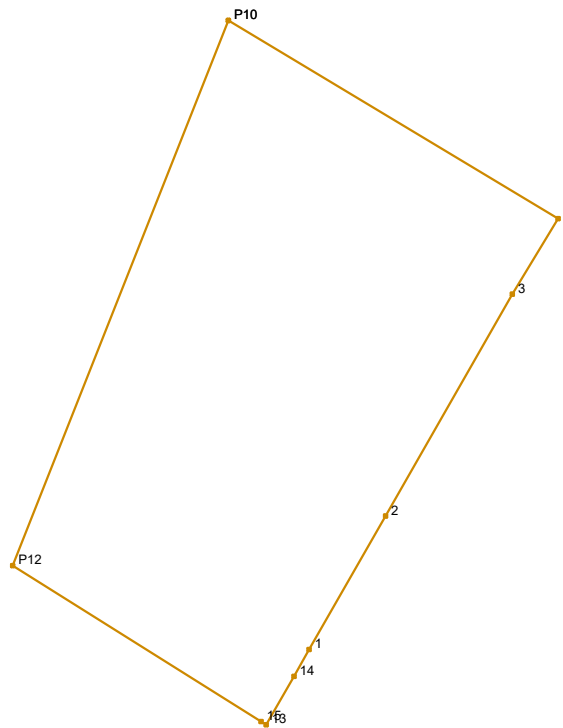

Νέα ιδιοκτησία εντός ΟΤ							
id1:1502		id2:04		Σημεία:9		Εμβαδό:184.56 m <sup>2</sup>	
Σημείο	X	Y	μήκος	Σημείο	X	Y	μήκος
P10	499238.889	3928975.048	11.74	14	499240.890	3928955.030	1.71
4	499248.949	3928968.992		13	499240.040	3928953.550	
3	499247.557	3928966.691	7.80	15	499239.882	3928953.651	8.95
2	499243.683	3928959.915		P12	499232.301	3928958.405	
1	499241.355	3928955.844	4.69	P10	499238.889	3928975.048	0.94

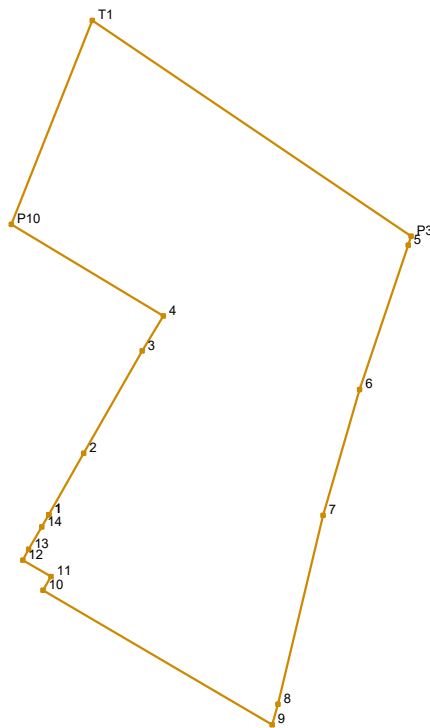

Νέα ιδιοκτησία εντός ΟΤ							
id1:1502		id2:05		Σημεία:17		Εμβαδό:679.93 m <sup>2</sup>	
Σημείο	X	Y	μήκος	Σημείο	X	Y	μήκος
1	499241.355	3928955.844		7	499259.514	3928955.794	12.84
2	499243.683	3928959.915	4.69	8	499256.544	3928943.301	1.42
3	499247.557	3928966.691	7.80	9	499256.147	3928941.940	17.58
4	499248.949	3928968.992	2.69	10	499240.977	3928950.834	1.07
P10	499238.889	3928975.048	11.74	11	499241.520	3928951.760	2.17
T1	499244.237	3928988.561	14.53	12	499239.640	3928952.840	0.81
P3	499265.356	3928974.270	25.50	13	499240.040	3928953.550	1.71
5	499265.160	3928973.673	0.63	14	499240.890	3928955.030	0.94
6	499261.936	3928964.122	10.08	1	499241.355	3928955.844	
			8.67				

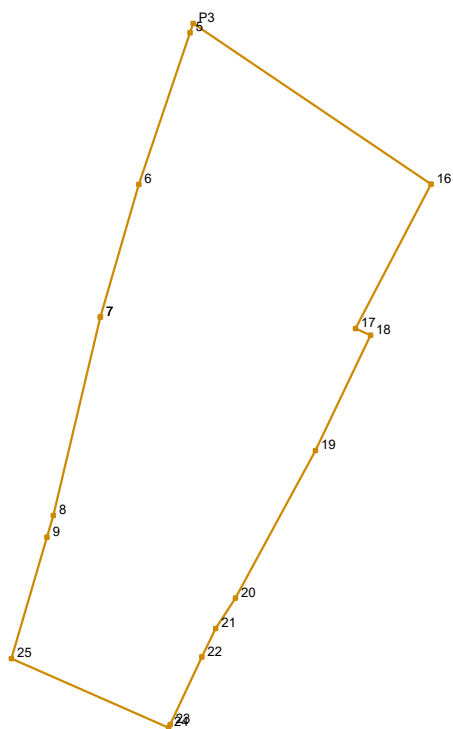

Νέα ιδιοκτησία εντός ΟΤ							
id1:1502		id2:06		Σημεία:16		Εμβαδό:581.12 m <sup>2</sup>	
Σημείο	X	Y	μήκος	Σημείο	X	Y	μήκος
7	499259.514	3928955.794		21	499266.768	3928936.191	
			8.67				1.99
6	499261.936	3928964.122		22	499265.894	3928934.400	
			10.08				4.69
5	499265.160	3928973.673		23	499263.897	3928930.155	
			0.63				0.22
P3	499265.356	3928974.270		24	499263.802	3928929.955	
			18.07				10.80
16	499280.322	3928964.143		25	499253.919	3928934.298	
			10.24				7.96
17	499275.558	3928955.074		9	499256.147	3928941.940	
			1.04				1.42
18	499276.514	3928954.653		8	499256.544	3928943.301	
			8.04				12.84
19	499273.051	3928947.395		7	499259.514	3928955.794	
			10.56				
20	499268.019	3928938.108					
			2.29				

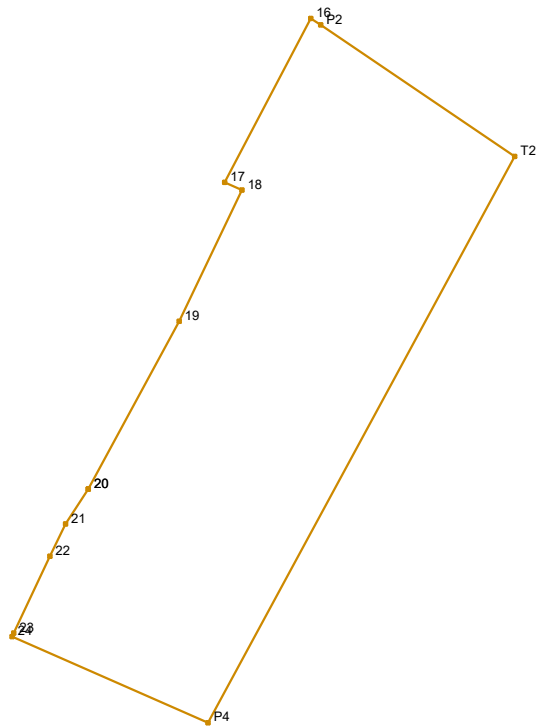

Νέα ιδιοκτησία εντός ΟΤ							
id1:1502		id2:07		Σημεία:12		Εμβαδό:456.77 m <sup>2</sup>	
Σημείο	X	Y	μήκος	Σημείο	X	Y	μήκος
20	499268.019	3928938.108	10.56	P4	499274.645	3928925.190	11.84
19	499273.051	3928947.395	8.04	24	499263.802	3928929.955	0.22
18	499276.514	3928954.653	1.04	23	499263.897	3928930.155	4.69
17	499275.558	3928955.074	10.24	22	499265.894	3928934.400	1.99
16	499280.322	3928964.143	0.66	21	499266.768	3928936.191	2.29
P2	499280.866	3928963.775	12.96	20	499268.019	3928938.108	
T2	499291.600	3928956.512	35.62				



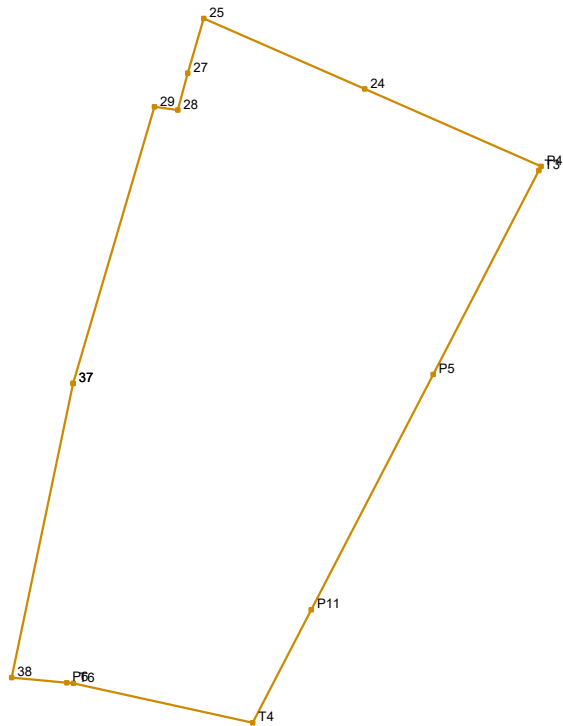

Νέα ιδιοκτησία εντός ΟΤ							
id1:1502		id2:08N		Σημεία:14		Εμβαδό:786.78 m <sup>2</sup>	
Σημείο	X	Y	μήκος	Σημείο	X	Y	μήκος
37	499245.898	3928911.869	17.71	P5	499268.021	3928912.416	16.30
29	499250.894	3928928.864	1.45	P11	499260.524	3928897.945	7.81
28	499252.329	3928928.664	2.34	T4	499256.929	3928891.007	11.29
27	499252.935	3928930.924	3.51	T6	499245.907	3928893.436	0.42
25	499253.919	3928934.298	10.80	P6	499245.493	3928893.474	3.40
24	499263.802	3928929.955	11.84	38	499242.110	3928893.789	18.47
P4	499274.645	3928925.190	0.27	37	499245.898	3928911.869	
T3	499274.514	3928924.948	14.11				

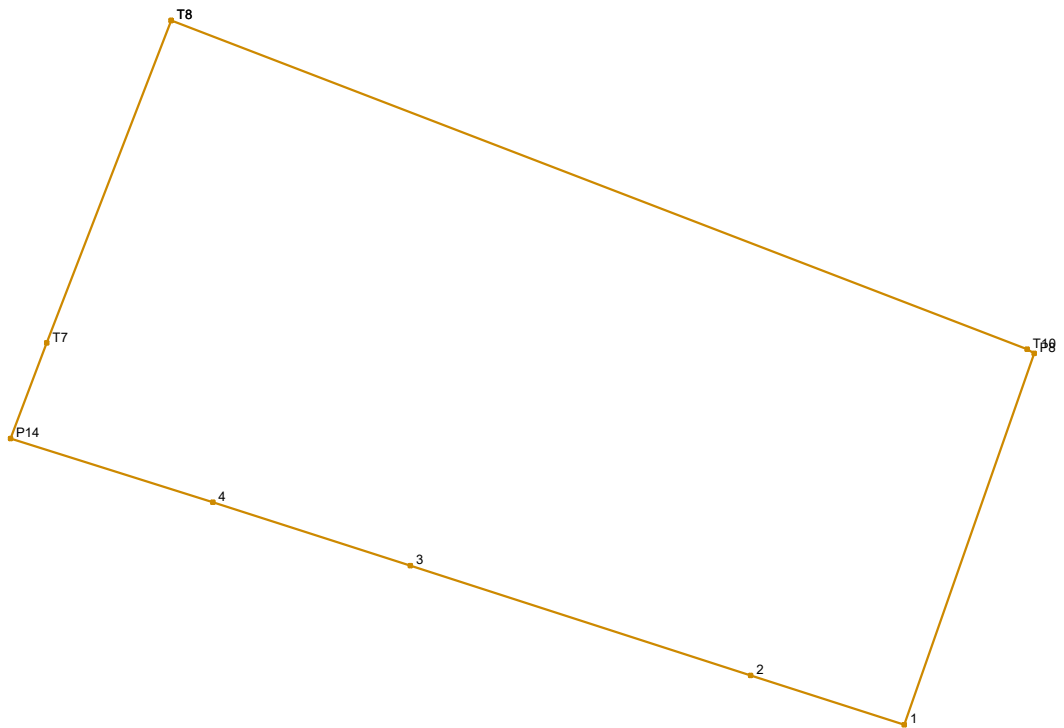

Νέα ιδιοκτησία εντός ΟΤ							
id1:1503		id2:01		Σημεία:9		Εμβαδό:170.13 m <sup>2</sup>	
Σημείο	X	Y	μήκος	Σημείο	X	Y	μήκος
T8	499149.464	3928869.090	19.10	3	499154.443	3928857.727	4.32
T10	499167.293	3928862.237		0.17	4	499150.330	3928859.051
P8	499167.440	3928862.148	8.19	P14	499146.112	3928860.379	2.13
1	499164.732	3928854.414	3.36	T7	499146.866	3928862.368	7.21
2	499161.534	3928855.444	7.45	T8	499149.464	3928869.090	

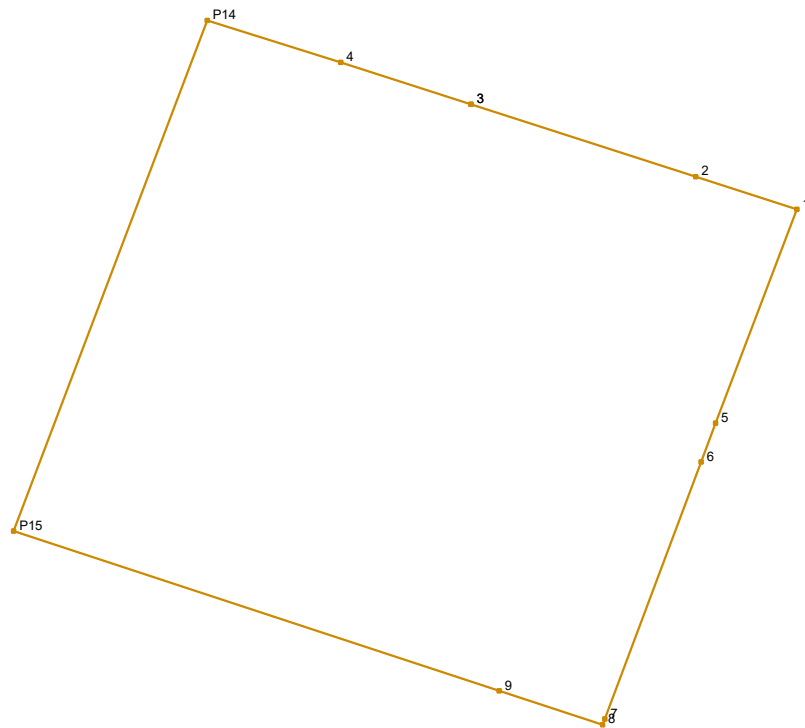

Νέα ιδιοκτησία εντός ΟΤ							
id1:1503		id2:02		Σημεία:11		Εμβαδό:338.51 m <sup>2</sup>	
Σημείο	X	Y	μήκος	Σημείο	X	Y	μήκος
3	499154.443	3928857.727	7.45	8	499158.590	3928838.139	3.43
2	499161.534	3928855.444	3.36	9	499155.328	3928839.212	16.14
1	499164.732	3928854.414	7.23	P15	499139.996	3928844.252	17.25
5	499162.158	3928847.656	1.30	P14	499146.112	3928860.379	4.42
6	499161.701	3928846.436	8.66	4	499150.330	3928859.051	4.32
7	499158.666	3928838.325	0.20	3	499154.443	3928857.727	

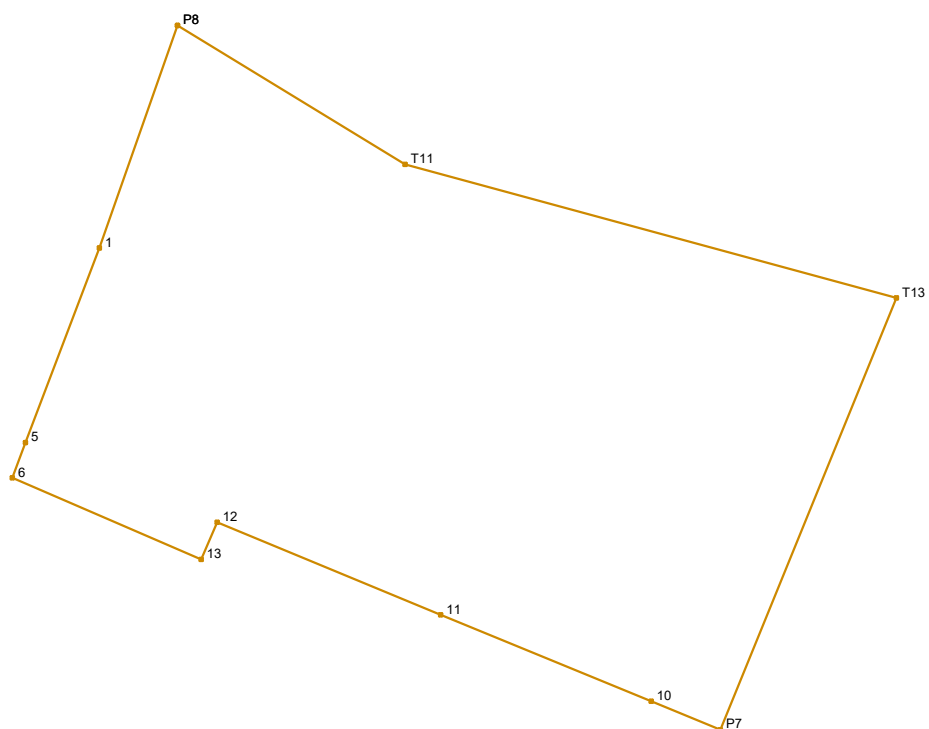

Νέα ιδιοκτησία εντός ΟΤ							
id1:1503		id2:03		Σημεία:11		Εμβαδό:403.61 m <sup>2</sup>	
Σημείο	X	Y	μήκος	Σημείο	X	Y	μήκος
P8	499167.440	3928862.148	9.26	12	499168.819	3928844.892	1.41
T11	499175.339	3928857.315		13	499168.258	3928843.596	7.15
T13	499192.404	3928852.678	17.68	6	499161.701	3928846.436	1.30
P7	499186.293	3928837.688	16.19	5	499162.158	3928847.656	7.23
10	499183.886	3928838.673	2.60	1	499164.732	3928854.414	8.19
11	499176.576	3928841.673	7.90	P8	499167.440	3928862.148	8.40
			8.40				

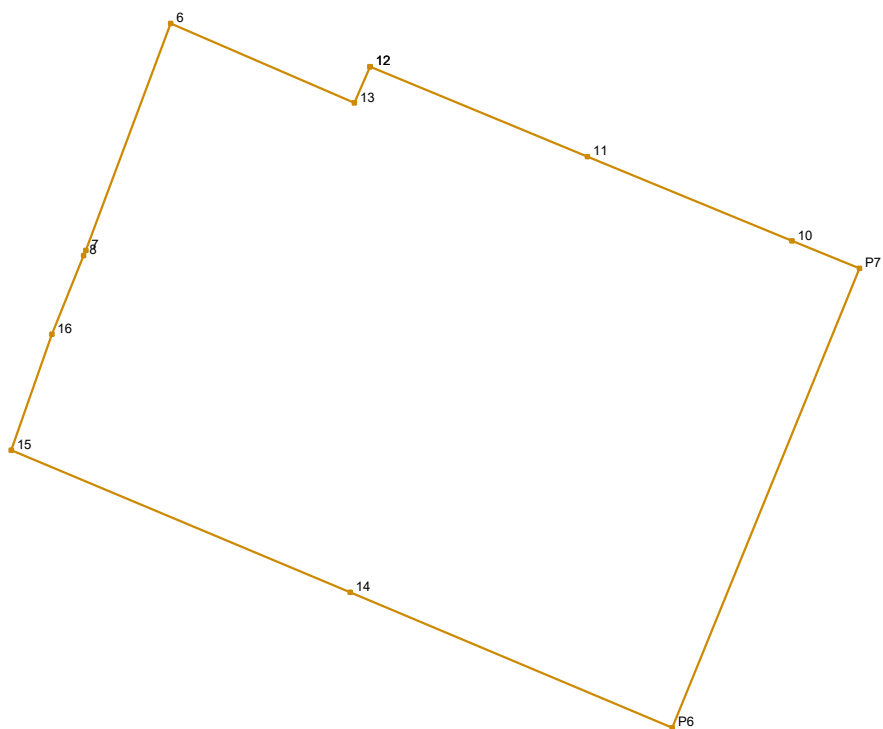

Νέα ιδιοκτησία εντός ΟΤ							
id1:1503		id2:04		Σημεία:12		Εμβαδό:446.26 m <sup>2</sup>	
Σημείο	X	Y	μήκος	Σημείο	X	Y	μήκος
12	499168.819	3928844.892	8.40	16	499157.454	3928835.334	3.03
11	499176.576	3928841.673	7.90	8	499158.590	3928838.139	0.20
10	499183.886	3928838.673	2.60	7	499158.666	3928838.325	8.66
P7	499186.293	3928837.688	17.71	6	499161.701	3928846.436	7.15
P6	499179.607	3928821.286	12.47	13	499168.258	3928843.596	1.41
14	499168.108	3928826.115	13.13	12	499168.819	3928844.892	
15	499156.003	3928831.199	4.38				

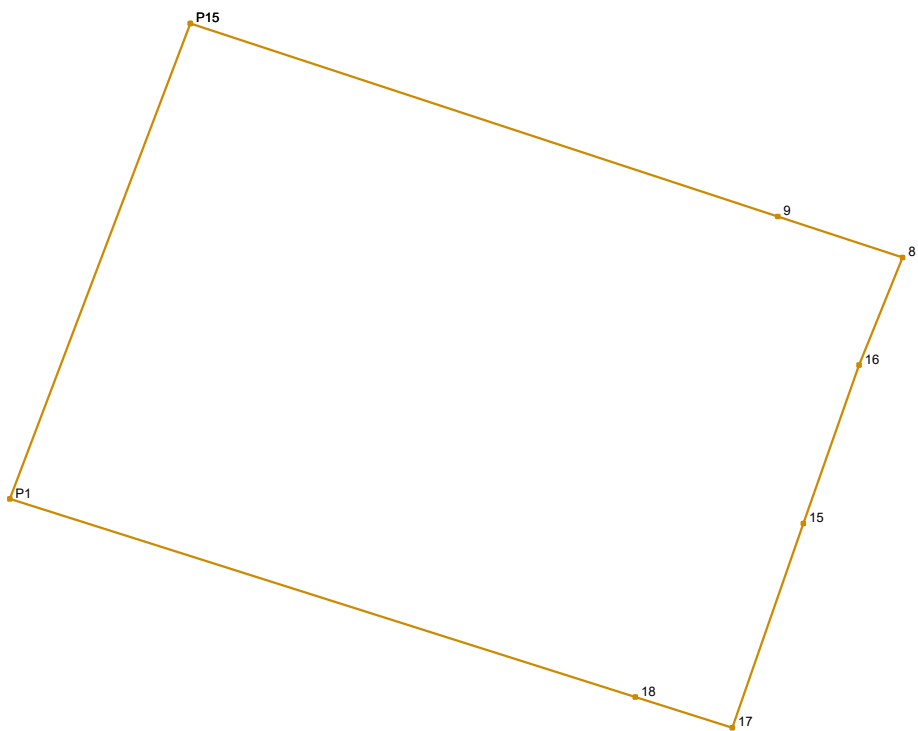

Νέα ιδιοκτησία εντός ΟΤ							
id1:1503		id2:05		Σημεία:8		Εμβαδό:257.99 m <sup>2</sup>	
Σημείο	X	Y	μήκος	Σημείο	X	Y	μήκος
P15	499139.996	3928844.252	16.14	17	499154.142	3928825.866	2.65
9	499155.328	3928839.212	3.43	18	499151.612	3928826.668	17.12
8	499158.590	3928838.139	3.03	P1	499135.290	3928831.842	13.27
16	499157.454	3928835.334	4.38	P15	499139.996	3928844.252	
15	499156.003	3928831.199	5.65				

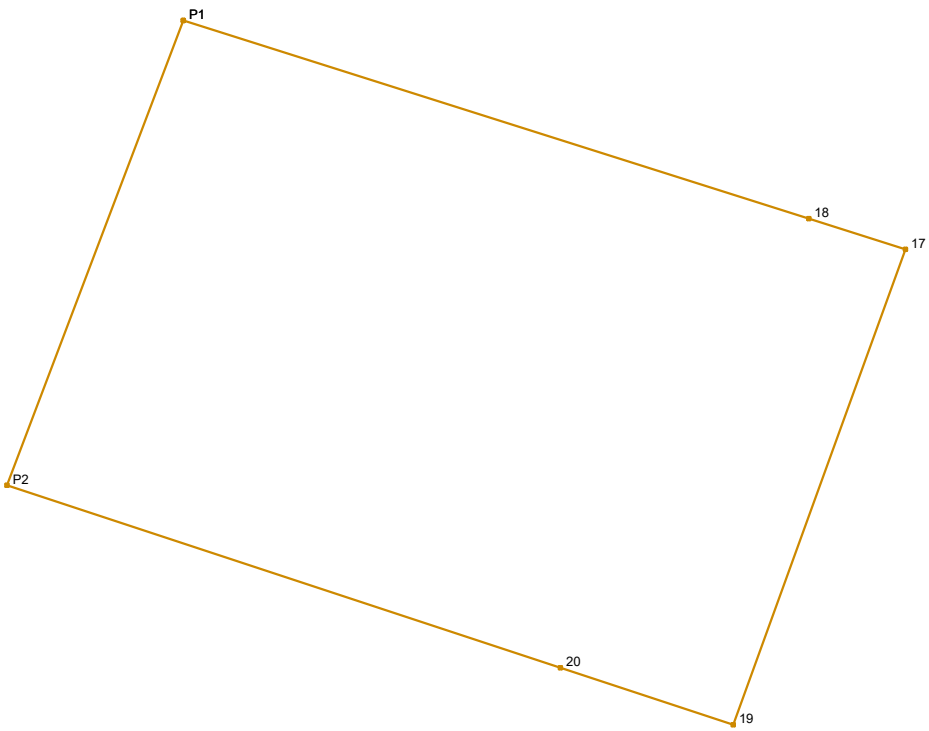

Νέα ιδιοκτησία εντός ΟΤ							
id1:1503		id2:06		Σημεία:6		Εμβαδό:259.73 m <sup>2</sup>	
Σημείο	X	Y	μήκος	Σημείο	X	Y	μήκος
P1	499135.290	3928831.842	17.12	20	499145.134	3928814.948	15.21
18	499151.612	3928826.668	2.65	P2	499130.689	3928819.711	12.97
17	499154.142	3928825.866	13.20	P1	499135.290	3928831.842	
19	499149.646	3928813.460	4.75				

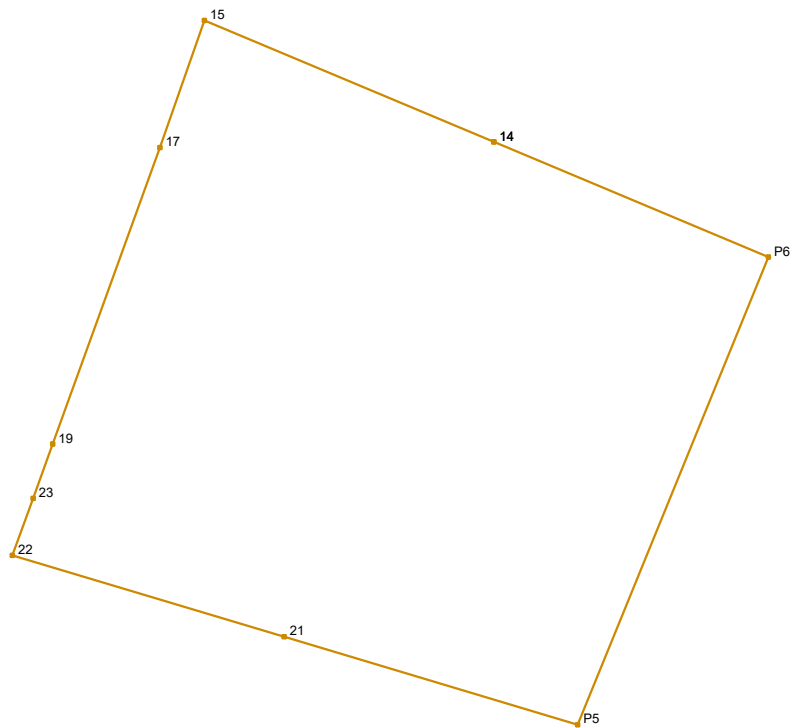

Νέα ιδιοκτησία εντός ΟΤ							
id1:1503		id2:07		Σημεία:9		Εμβαδό:563.61 m <sup>2</sup>	
Σημείο	X	Y	μήκος	Σημείο	X	Y	μήκος
14	499168.108	3928826.115	12.47	23	499148.823	3928811.189	2.42
P6	499179.607	3928821.286		19	499149.646	3928813.460	
P5	499171.625	3928801.708	12.84	17	499154.142	3928825.866	5.65
21	499159.330	3928805.392		15	499156.003	3928831.199	
22	499147.957	3928808.801	2.54	14	499168.108	3928826.115	



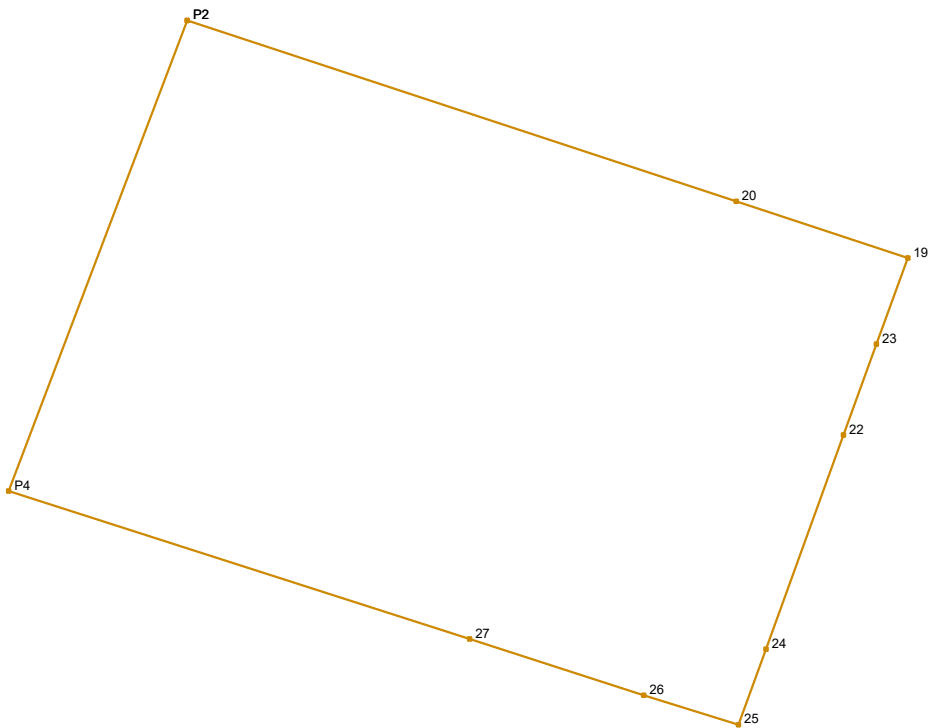

Νέα ιδιοκτησία εντός ΟΤ							
id1:1503		id2:08		Σημεία:10		Εμβαδό:263.78 m <sup>2</sup>	
Σημείο	X	Y	μήκος	Σημείο	X	Y	μήκος
P2	499130.689	3928819.711	15.21	25	499145.191	3928801.179	2.61
20	499145.134	3928814.948		4.75	26	499142.697	3928801.950
19	499149.646	3928813.460	2.42	27	499138.119	3928803.438	12.73
23	499148.823	3928811.189	2.54	P4	499125.993	3928807.329	13.24
22	499147.957	3928808.801	5.99	P2	499130.689	3928819.711	
24	499145.914	3928803.171	2.12				

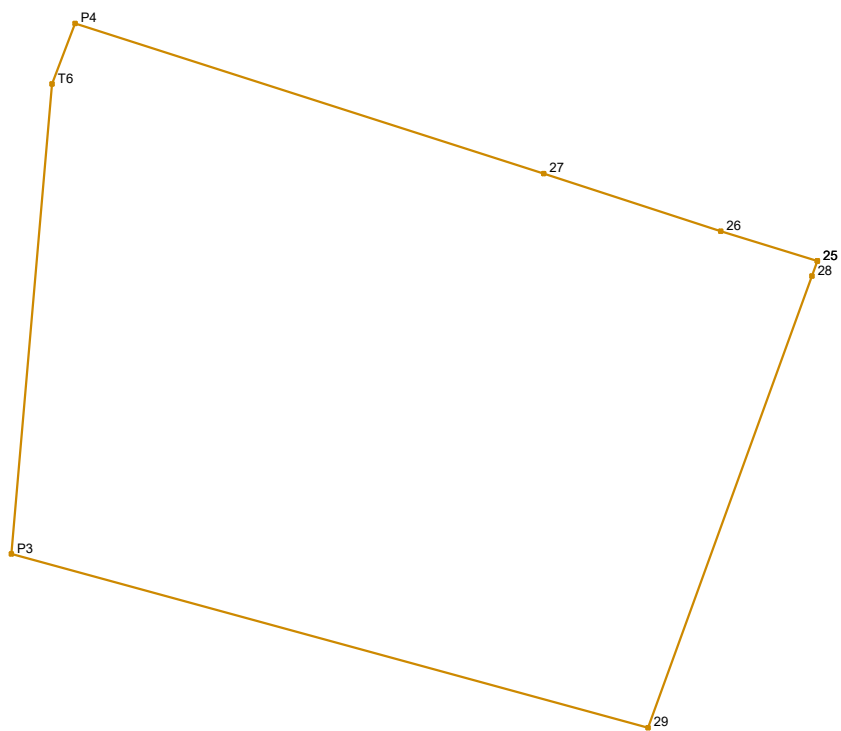

Νέα ιδιοκτησία εντός ΟΤ							
id1:1503		id2:09		Σημεία:8		Εμβαδό:248.65 m <sup>2</sup>	
Σημείο	X	Y	μήκος	Σημείο	X	Y	μήκος
25	499145.191	3928801.179	0.41	P4	499125.993	3928807.329	12.73
28	499145.051	3928800.792	12.43	27	499138.119	3928803.438	4.81
29	499140.812	3928789.109	17.07	26	499142.697	3928801.950	2.61
P3	499124.345	3928793.607	12.20	25	499145.191	3928801.179	
T6	499125.398	3928805.760	1.68				

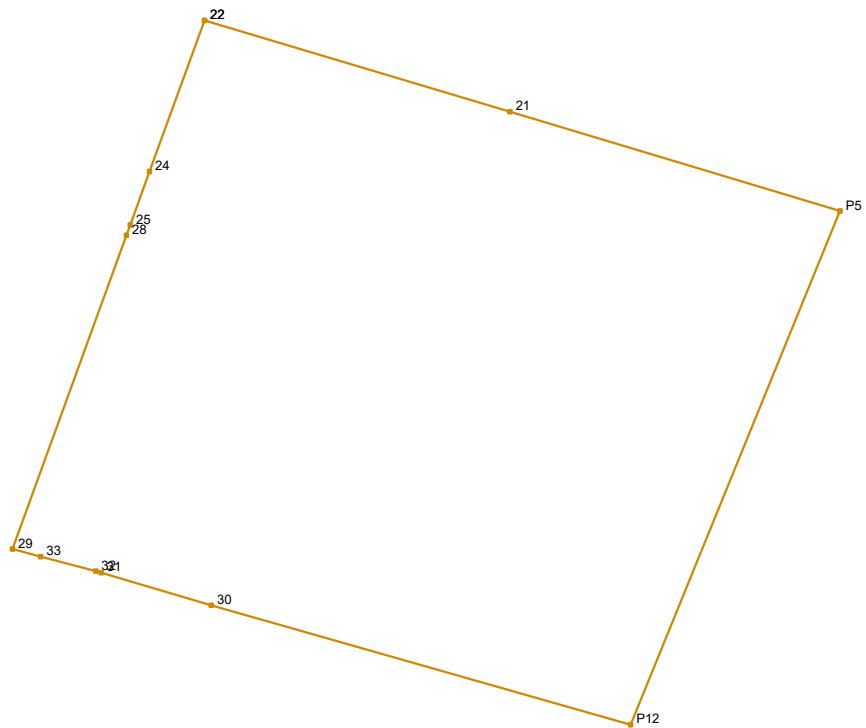

Νέα ιδιοκτησία εντός ΟΤ							
id1:1503		id2:10		Σημεία:12		Εμβαδό:503.76 m <sup>2</sup>	
Σημείο	X	Y	μήκος	Σημείο	X	Y	μήκος
22	499147.957	3928808.801		33	499141.858	3928788.823	
			11.87				1.08
21	499159.330	3928805.392		29	499140.812	3928789.109	
			12.84				12.43
P5	499171.625	3928801.708		28	499145.051	3928800.792	
			20.67				0.41
P12	499163.824	3928782.569		25	499145.191	3928801.179	
			16.24				2.12
30	499148.209	3928787.017		24	499145.914	3928803.171	
			4.28				5.99
31	499144.106	3928788.235		22	499147.957	3928808.801	
			0.20				
32	499143.911	3928788.293					
			2.12				

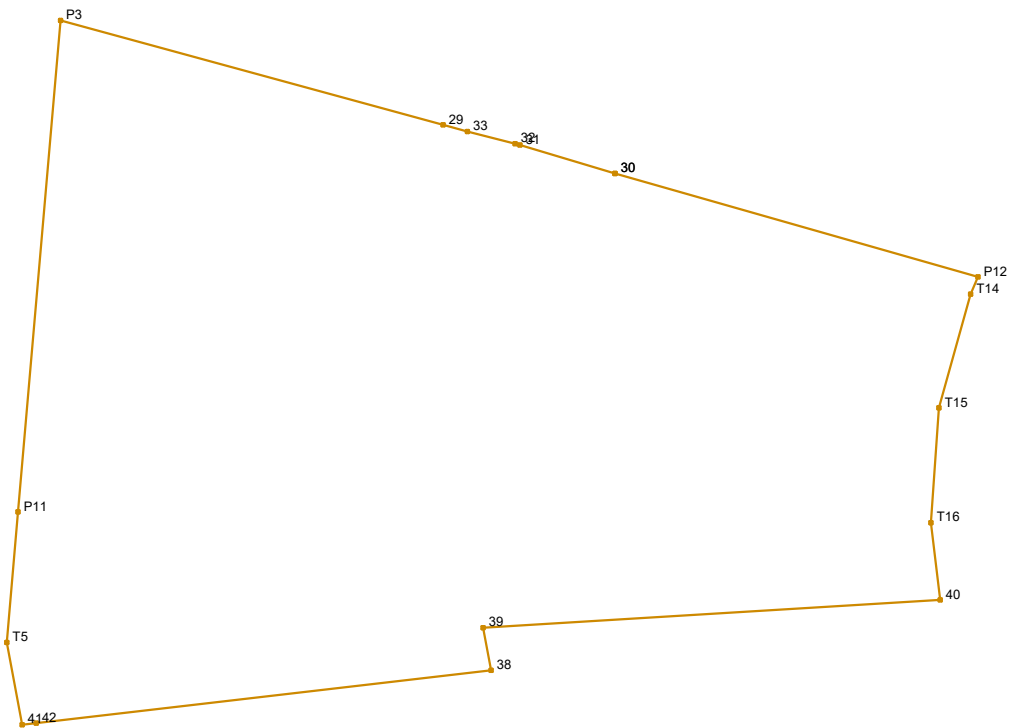

Νέα ιδιοκτησία εντός ΟΤ							
id1:1503		id2:11		Σημεία:17		Εμβαδό:874.42 m <sup>2</sup>	
Σημείο	X	Y	μήκος	Σημείο	X	Y	μήκος
30	499148.209	3928787.017		41	499122.682	3928763.287	
			16.24				3.60
P12	499163.824	3928782.569		T5	499122.025	3928766.826	
			0.81				5.65
T14	499163.520	3928781.824		P11	499122.513	3928772.455	
			5.09				21.23
T15	499162.155	3928776.924		P3	499124.345	3928793.607	
			4.96				17.07
T16	499161.805	3928771.975		29	499140.812	3928789.109	
			3.34				1.08
40	499162.207	3928768.663		33	499141.858	3928788.823	
			19.71				2.12
39	499142.530	3928767.458		32	499143.911	3928788.293	
			1.86				0.20
38	499142.878	3928765.627		31	499144.106	3928788.235	
			19.72				4.28
42	499123.288	3928763.357		30	499148.209	3928787.017	
			0.61				

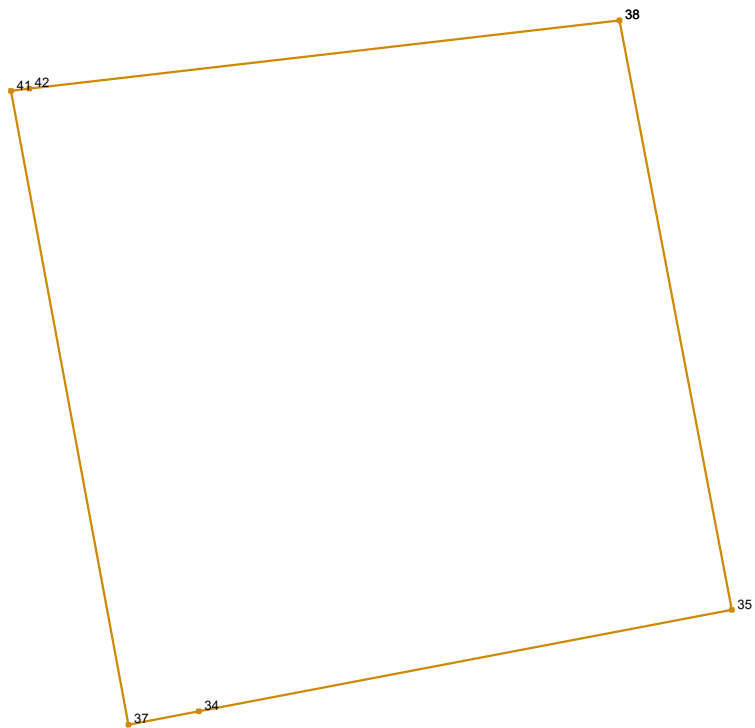

Νέα ιδιοκτησία εντός ΟΤ							
id1:1503		id2:12		Σημεία:6		Εμβαδό:420.00 m <sup>2</sup>	
Σημείο	X	Y	μήκος	Σημείο	X	Y	μήκος
38	499142.878	3928765.627		41	499122.682	3928763.287	
			19.92				0.61
35	499146.607	3928746.063		42	499123.288	3928763.357	
			18.00				19.72
34	499128.925	3928742.693		38	499142.878	3928765.627	
			2.38				
37	499126.585	3928742.247					
			21.40				

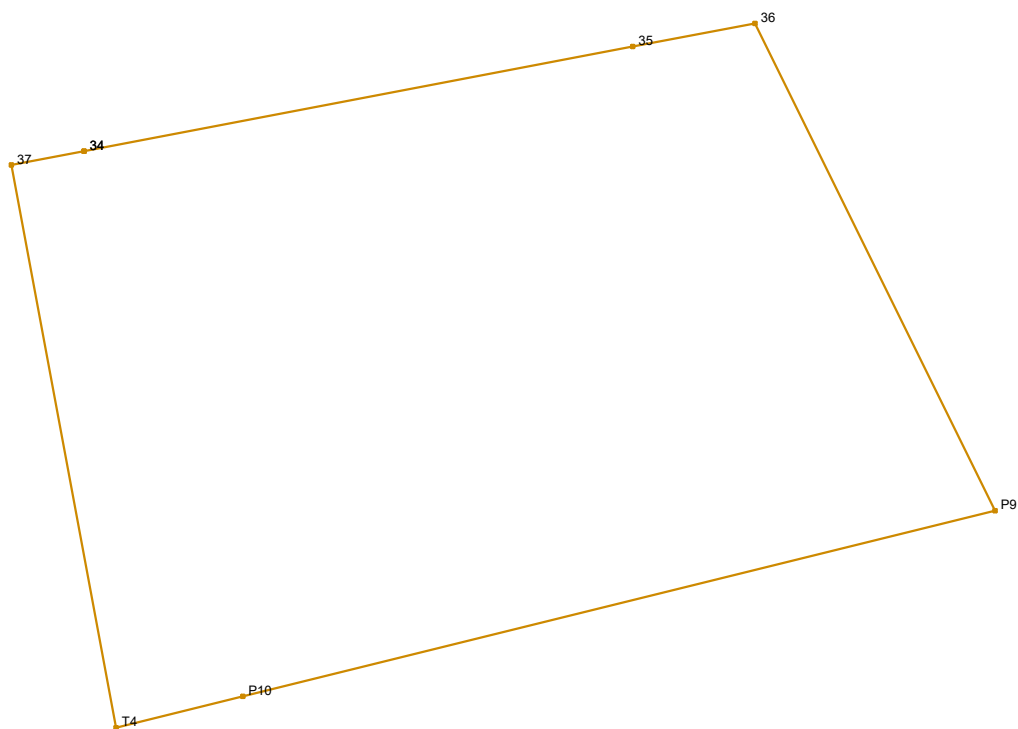

Νέα ιδιοκτησία εντός ΟΤ							
id1:1503		id2:13		Σημεία:7		Εμβαδό:474.40 m <sup>2</sup>	
Σημείο	X	Y	μήκος	Σημείο	X	Y	μήκος
34	499128.925	3928742.693	18.00	P10	499134.042	3928725.124	4.22
35	499146.607	3928746.063	4.00	T4	499129.949	3928724.113	18.44
36	499150.540	3928746.812	17.51	37	499126.585	3928742.247	2.38
P9	499158.279	3928731.107	24.97	34	499128.925	3928742.693	

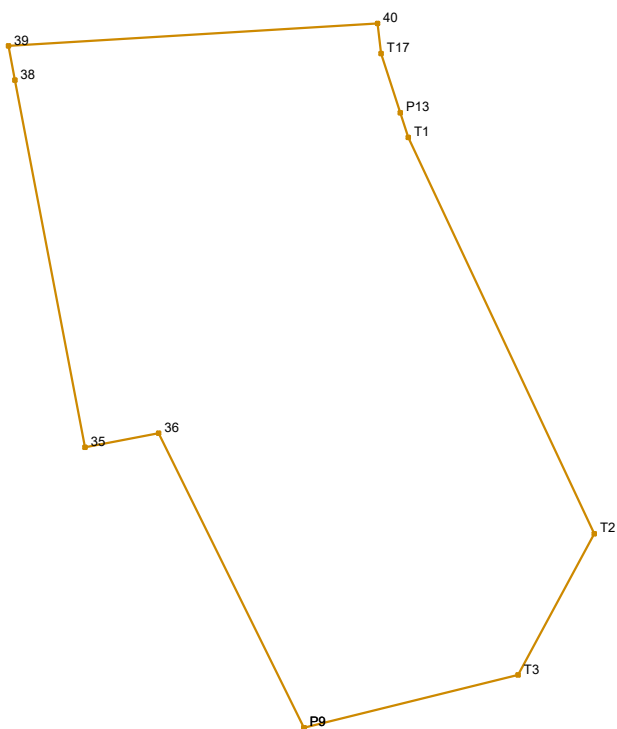

Νέα ιδιοκτησία εντός ΟΤ							
id1:1503		id2:14		Σημεία:11		Εμβαδό:721.78 m <sup>2</sup>	
Σημείο	X	Y	μήκος	Σημείο	X	Y	μήκος
P9	499158.279	3928731.107	17.51	T17	499162.403	3928767.050	3.31
36	499150.540	3928746.812	4.00	P13	499163.419	3928763.900	1.39
35	499146.607	3928746.063	19.92	T1	499163.846	3928762.577	23.35
38	499142.878	3928765.627	1.86	T2	499173.762	3928741.442	8.54
39	499142.530	3928767.458	19.71	T3	499169.700	3928733.927	11.76
40	499162.207	3928768.663	1.62	P9	499158.279	3928731.107	

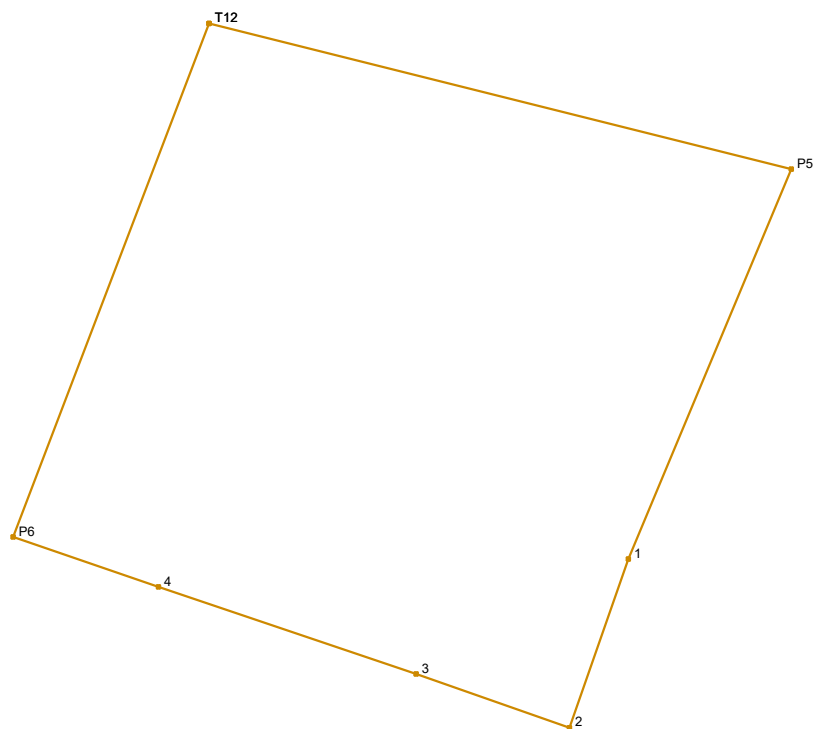

Νέα ιδιοκτησία εντός ΟΤ							
id1:1504		id2:01		Σημεία:7		Εμβαδό:326.92 m <sup>2</sup>	
Σημείο	X	Y	μήκος	Σημείο	X	Y	μήκος
T12	499177.423	3928942.440	18.68	3	499183.866	3928922.198	8.46
P5	499195.542	3928937.902		4	499175.849	3928924.913	4.77
1	499190.468	3928925.775	5.56	P6	499171.336	3928926.460	17.10
2	499188.636	3928920.529	5.05	T12	499177.423	3928942.440	



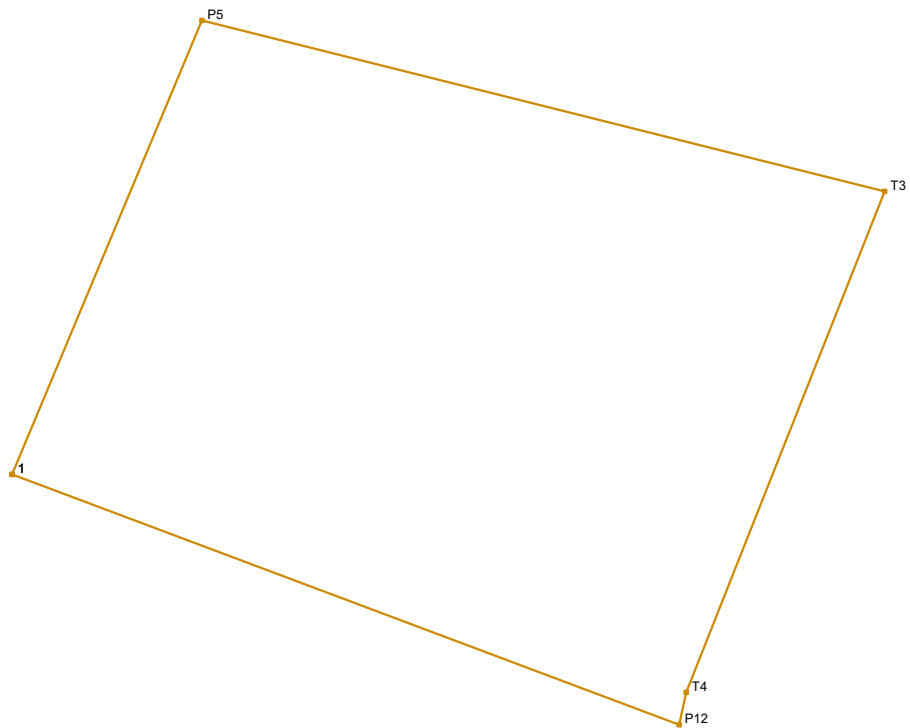

Νέα ιδιοκτησία εντός ΟΤ							
id1:1504		id2:02		Σημεία:5		Εμβαδό:266.42 m <sup>2</sup>	
Σημείο	X	Y	μήκος	Σημείο	X	Y	μήκος
1	499190.468	3928925.775	13.15	T4	499208.477	3928919.951	0.89
P5	499195.542	3928937.902	18.80	P12	499208.289	3928919.086	19.04
T3	499213.775	3928933.335	14.39	1	499190.468	3928925.775	

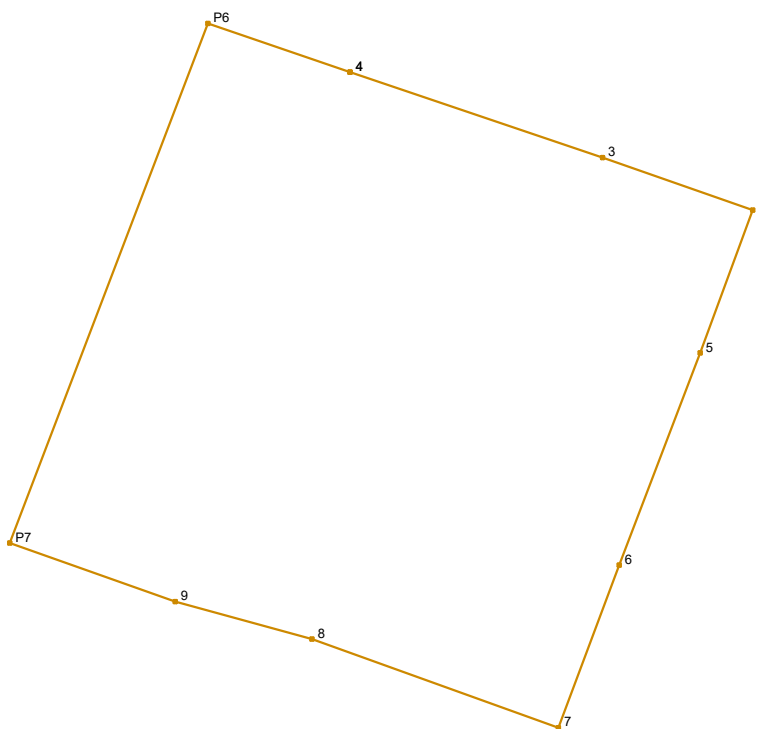

Νέα ιδιοκτησία εντός ΟΤ							
id1:1504		id2:03		Σημεία:10		Εμβαδό:322.21 m <sup>2</sup>	
Σημείο	X	Y	μήκος	Σημείο	X	Y	μήκος
4	499175.849	3928924.913	8.46	8	499174.640	3928906.907	4.50
3	499183.866	3928922.198	5.05	9	499170.302	3928908.104	5.57
2	499188.636	3928920.529	4.82	P7	499165.051	3928909.960	17.66
5	499186.969	3928916.002	7.22	P6	499171.336	3928926.460	4.77
6	499184.393	3928909.261	5.51	4	499175.849	3928924.913	
7	499182.465	3928904.097	8.31				

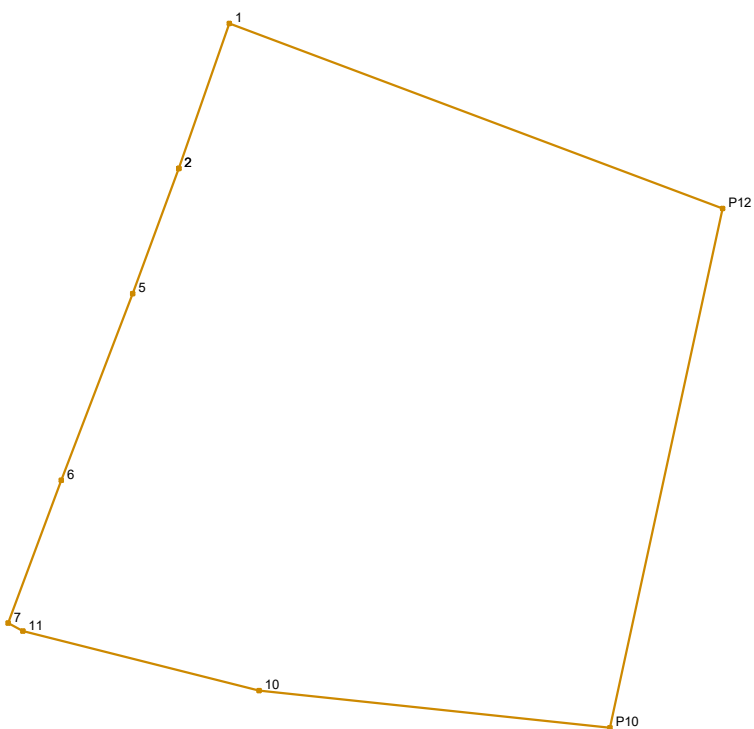

Νέα ιδιοκτησία εντός ΟΤ							
id1:1504		id2:04		Σημεία:9		Εμβαδό:440.61 m <sup>2</sup>	
Σημείο	X	Y	μήκος	Σημείο	X	Y	μήκος
2	499188.636	3928920.529	5.56	11	499182.999	3928903.804	0.61
1	499190.468	3928925.775		7	499182.465	3928904.097	
P12	499208.289	3928919.086	19.04	6	499184.393	3928909.261	7.22
P10	499204.215	3928900.315	19.21	5	499186.969	3928916.002	
10	499191.542	3928901.653	12.74	2	499188.636	3928920.529	
			8.81				

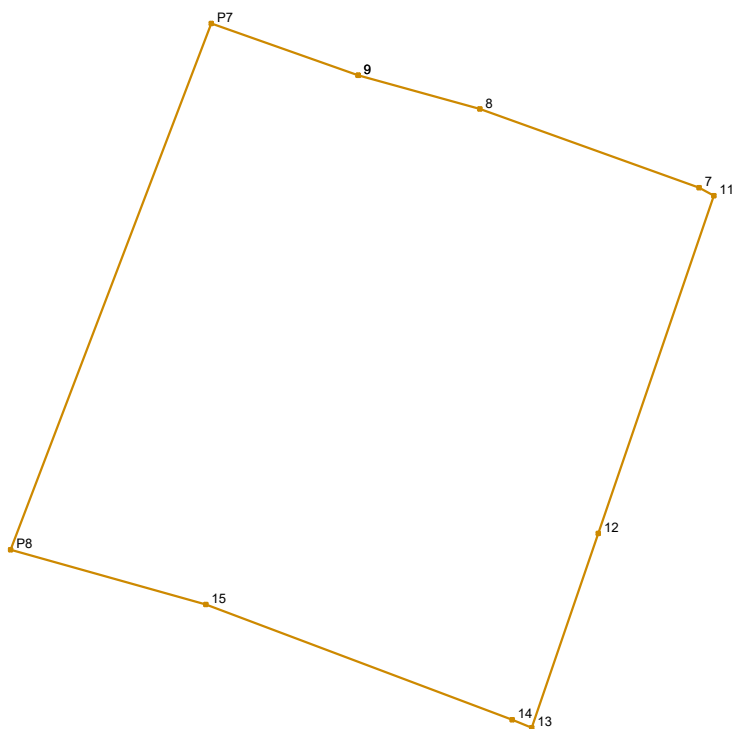

Νέα ιδιοκτησία εντός ΟΤ							
id1:1504		id2:05		Σημεία:10		Εμβαδό:385.53 m <sup>2</sup>	
Σημείο	X	Y	μήκος	Σημείο	X	Y	μήκος
9	499170.302	3928908.104	4.50	14	499175.801	3928885.097	11.69
8	499174.640	3928906.907	8.31	15	499164.859	3928889.209	7.24
7	499182.465	3928904.097	0.61	P8	499157.893	3928891.166	20.11
11	499182.999	3928903.804	12.74	P7	499165.051	3928909.960	5.57
12	499178.869	3928891.752	7.33	9	499170.302	3928908.104	
13	499176.492	3928884.814	0.75				

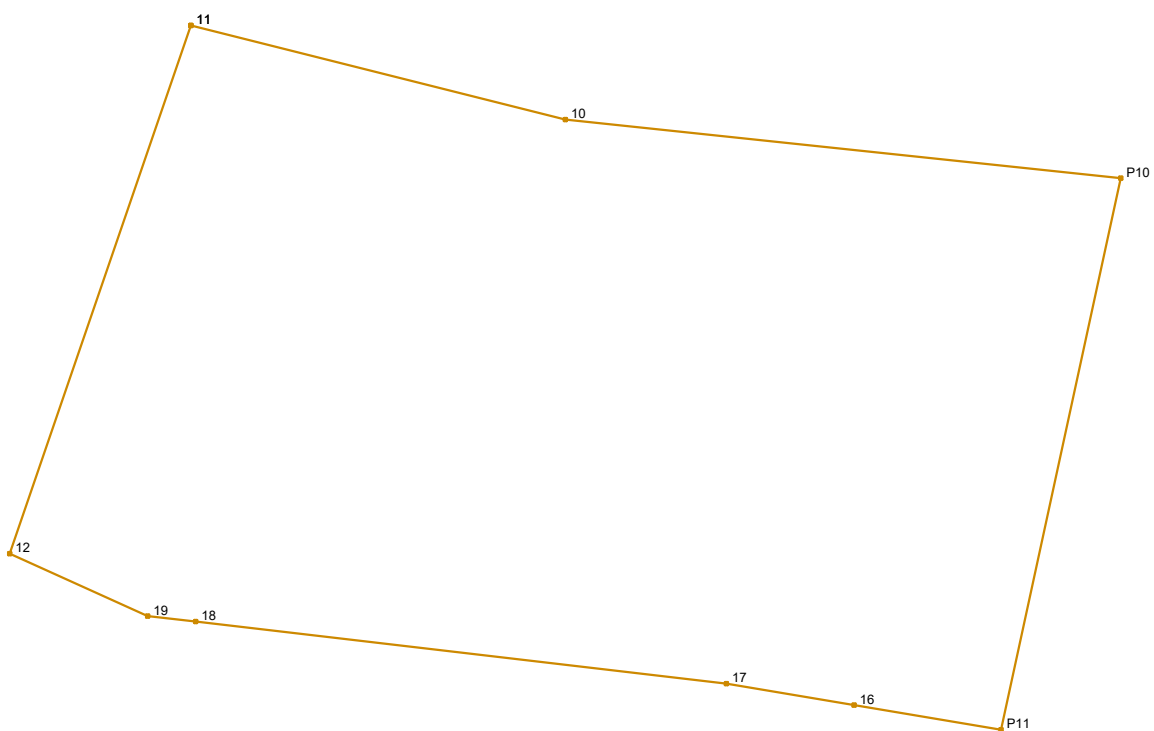

Νέα ιδιοκτησία εντός ΟΤ							
id1:1504		id2:06		Σημεία:9		Εμβαδό:282.52 m <sup>2</sup>	
Σημείο	X	Y	μήκος	Σημείο	X	Y	μήκος
11	499182.999	3928903.804	8.81	17	499195.216	3928888.787	12.19
10	499191.542	3928901.653	12.74	18	499183.106	3928890.202	1.10
P10	499204.215	3928900.315	12.87	19	499182.013	3928890.330	3.45
P11	499201.484	3928887.734	3.40	12	499178.869	3928891.752	12.74
16	499198.130	3928888.300	2.95	11	499182.999	3928903.804	

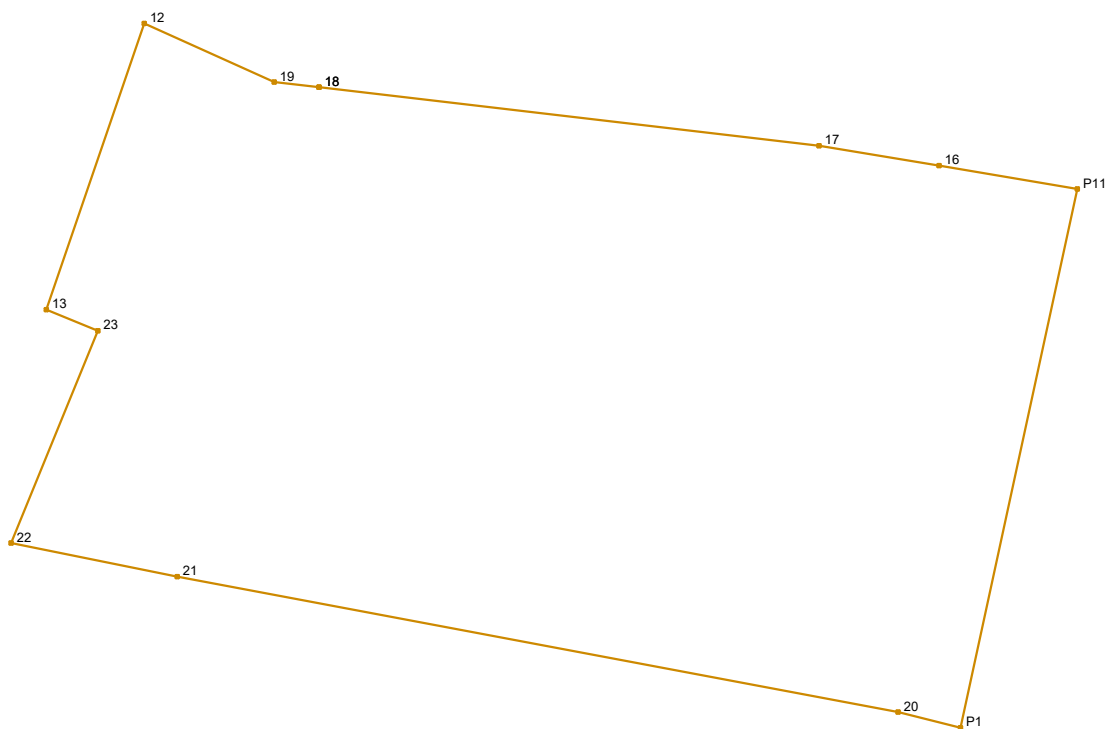

Νέα ιδιοκτησία εντός ΟΤ							
id1:1504		id2:07		Σημεία:12		Εμβαδό:297.31 m <sup>2</sup>	
Σημείο	X	Y	μήκος	Σημείο	X	Y	μήκος
18	499183.106	3928890.202	12.19	22	499175.639	3928879.158	5.56
17	499195.216	3928888.787	2.95	23	499177.745	3928884.301	1.35
16	499198.130	3928888.300	3.40	13	499176.492	3928884.814	7.33
P11	499201.484	3928887.734	13.36	12	499178.869	3928891.752	3.45
P1	499198.651	3928874.681	1.56	19	499182.013	3928890.330	1.10
20	499197.137	3928875.058	17.78	18	499183.106	3928890.202	
21	499179.665	3928878.346	4.11				

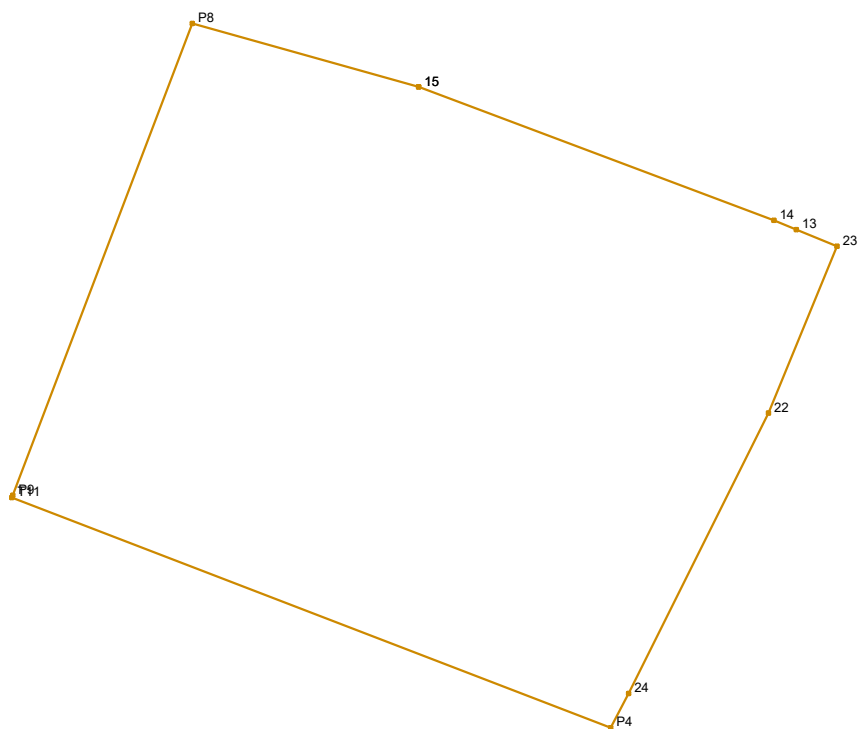

Νέα ιδιοκτησία εντός ΟΤ							
id1:1504		id2:08		Σημεία:10		Εμβαδό:332.85 m <sup>2</sup>	
Σημείο	X	Y	μήκος	Σημείο	X	Y	μήκος
15	499164.859	3928889.209	11.69	P4	499170.773	3928869.470	19.76
14	499175.801	3928885.097	0.75	T11	499152.329	3928876.559	0.07
13	499176.492	3928884.814	1.35	P9	499152.356	3928876.629	15.56
23	499177.745	3928884.301	5.56	P8	499157.893	3928891.166	7.24
22	499175.639	3928879.158	9.65	15	499164.859	3928889.209	
24	499171.329	3928870.527	1.19				

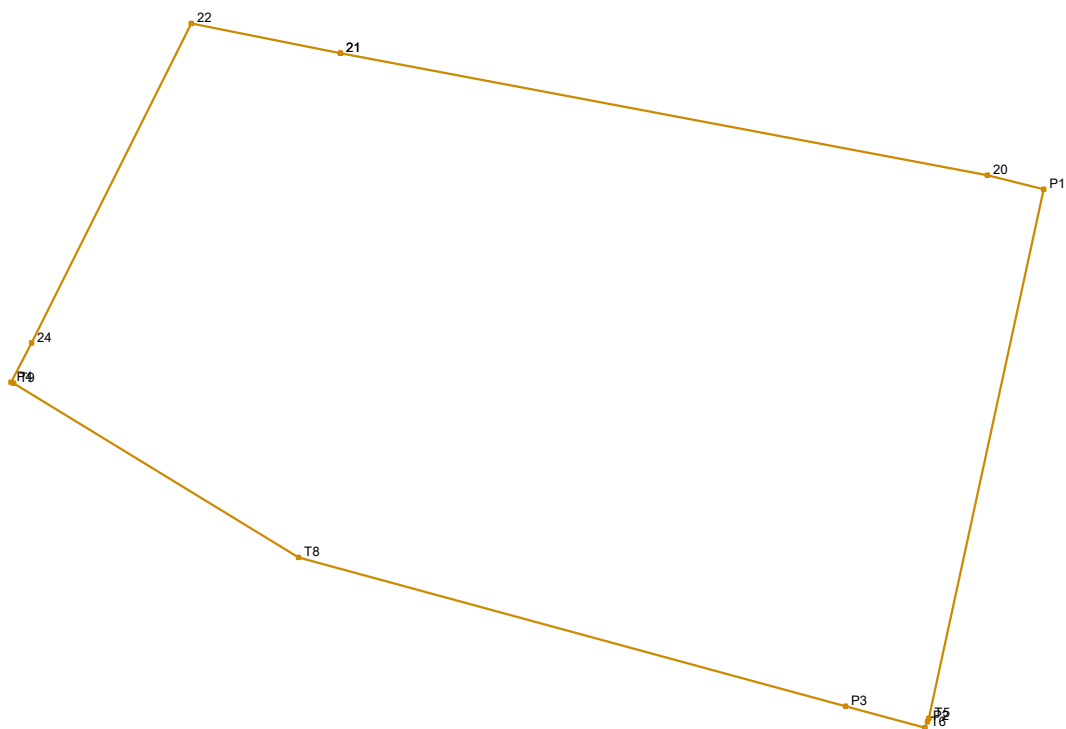

Νέα ιδιοκτησία εντός ΟΤ							
id1:1504		id2:09		Σημεία:12		Εμβαδό:339.50 m <sup>2</sup>	
Σημείο	X	Y	μήκος	Σημείο	X	Y	μήκος
21	499179.665	3928878.346	17.78	T8	499178.539	3928864.735	9.02
20	499197.137	3928875.058		T9	499170.845	3928869.443	0.08
P1	499198.651	3928874.681	1.56	P4	499170.773	3928869.470	1.19
T5	499195.549	3928860.392	14.62	24	499171.329	3928870.527	
P2	499195.514	3928860.306	0.09	22	499175.639	3928879.158	9.65
T6	499195.447	3928860.141	0.18	21	499179.665	3928878.346	4.11
P3	499193.302	3928860.724	2.22				
			15.30				



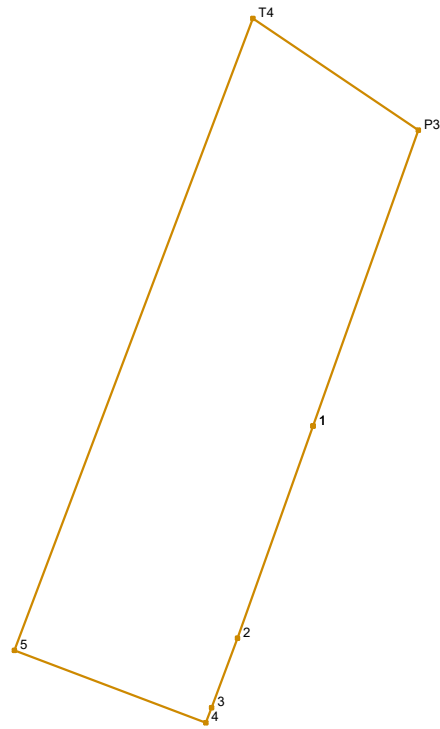

Νέα ιδιοκτησία εντός ΟΤ							
id1:1505		id2:01		Σημεία:7		Εμβαδό:571.09 m <sup>2</sup>	
Σημείο	X	Y	μήκος	Σημείο	X	Y	μήκος
1	499208.850	3928988.243	14.91	5	499189.086	3928973.389	44.69
2	499203.857	3928974.199	4.90	T4	499204.856	3929015.209	13.22
3	499202.136	3928969.610	1.07	P3	499215.804	3929007.801	20.76
4	499201.761	3928968.610	13.55	1	499208.850	3928988.243	

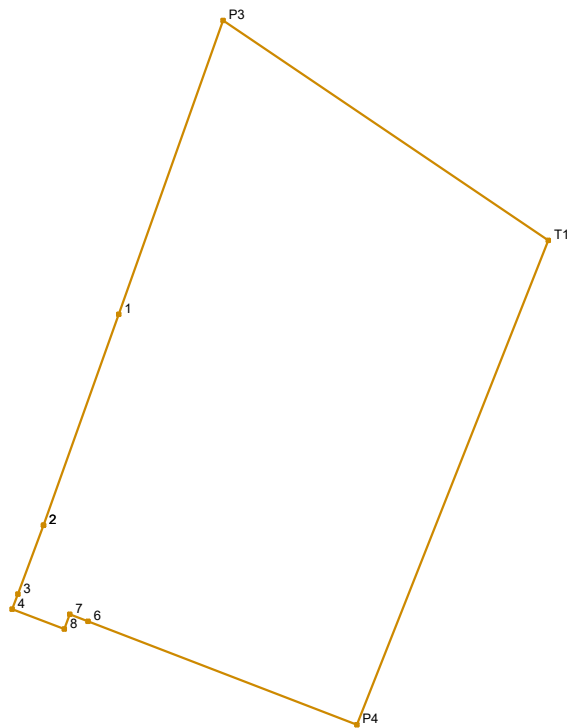

Νέα ιδιοκτησία εντός ΟΤ							
id1:1505		id2:02		Σημεία:10		Εμβαδό:934.77 m <sup>2</sup>	
Σημείο	X	Y	μήκος	Σημείο	X	Y	μήκος
2	499203.857	3928974.199	14.91	7	499205.592	3928968.279	1.04
1	499208.850	3928988.243	20.76	8	499205.235	3928967.300	3.71
P3	499215.804	3929007.801	26.14	4	499201.761	3928968.610	1.07
T1	499237.451	3928993.153	34.66	3	499202.136	3928969.610	4.90
P4	499224.695	3928960.926	19.17	2	499203.857	3928974.199	
6	499206.802	3928967.813	1.30				

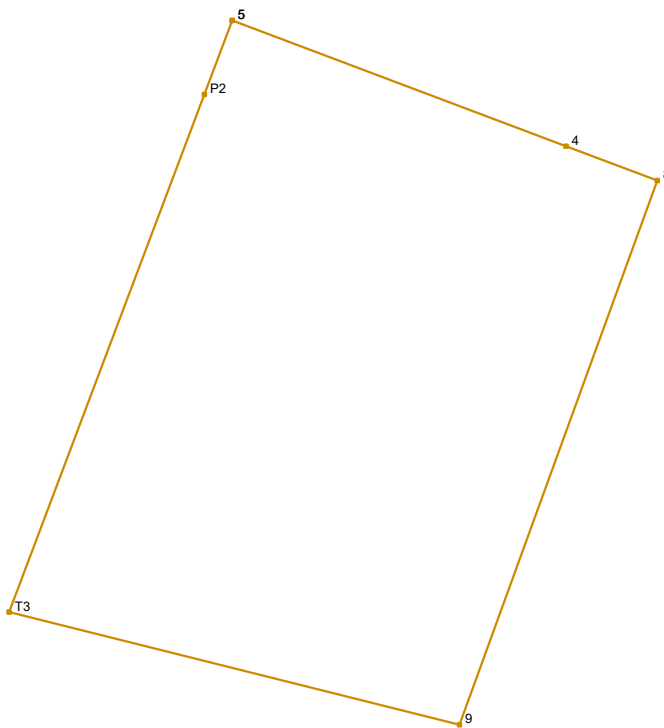

Νέα ιδιοκτησία εντός ΟΤ							
id1:1505		id2:03		Σημεία:6		Εμβαδό:400.00 m <sup>2</sup>	
Σημείο	X	Y	μήκος	Σημείο	X	Y	μήκος
5	499189.086	3928973.389	13.55	T3	499180.613	3928950.919	21.01
4	499201.761	3928968.610		3.71	P2	499188.026	3928970.577
8	499205.235	3928967.300	21.99		5	499189.086	3928973.389
9	499197.712	3928946.637	17.63				

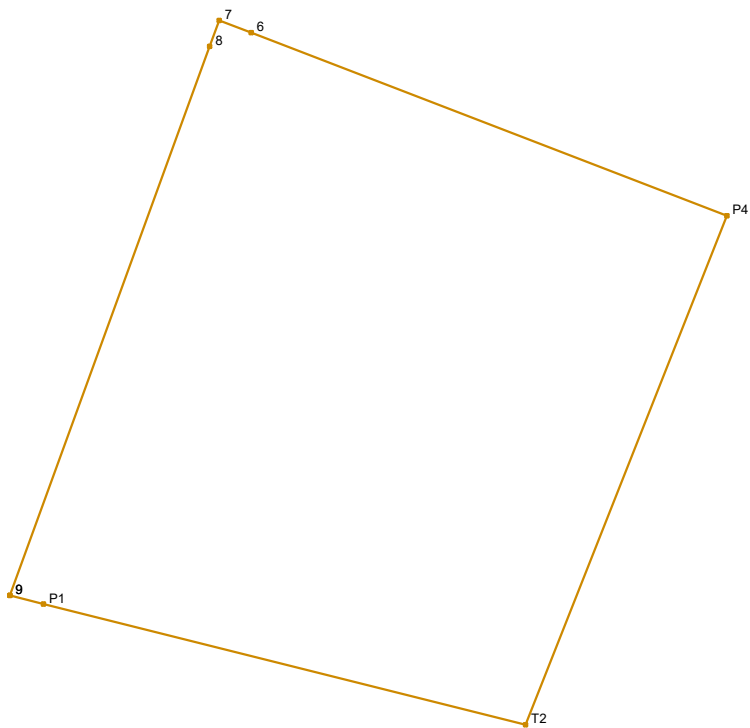

Νέα ιδιοκτησία εντός ΟΤ							
id1:1505		id2:04		Σημεία:7		Εμβαδό:439.91 m <sup>2</sup>	
Σημείο	X	Y	μήκος	Σημείο	X	Y	μήκος
9	499197.712	3928946.637	21.99	P4	499224.695	3928960.926	20.59
8	499205.235	3928967.300	1.04	T2	499217.116	3928941.777	18.70
7	499205.592	3928968.279	1.30	P1	499198.977	3928946.320	1.30
6	499206.802	3928967.813	19.17	9	499197.712	3928946.637	

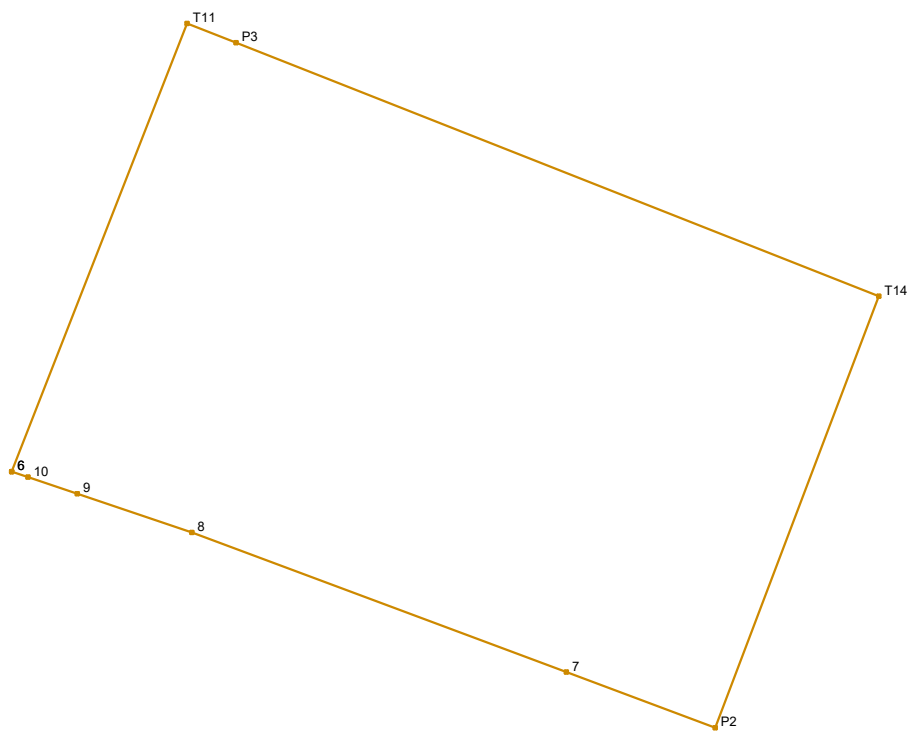

Νέα ιδιοκτησία εντός ΟΤ							
id1:1506		id2:01		Σημεία:9		Εμβαδό:320.50 m <sup>2</sup>	
Σημείο	X	Y	μήκος	Σημείο	X	Y	μήκος
6	499110.238	3928857.876	14.56	7	499127.027	3928851.808	12.10
T11	499115.546	3928871.438	1.59	8	499115.694	3928856.036	3.66
P3	499117.024	3928870.855	20.91	9	499112.226	3928857.206	1.57
T14	499136.481	3928863.184	13.97	10	499110.734	3928857.709	0.52
P2	499131.528	3928850.123	4.81	6	499110.238	3928857.876	

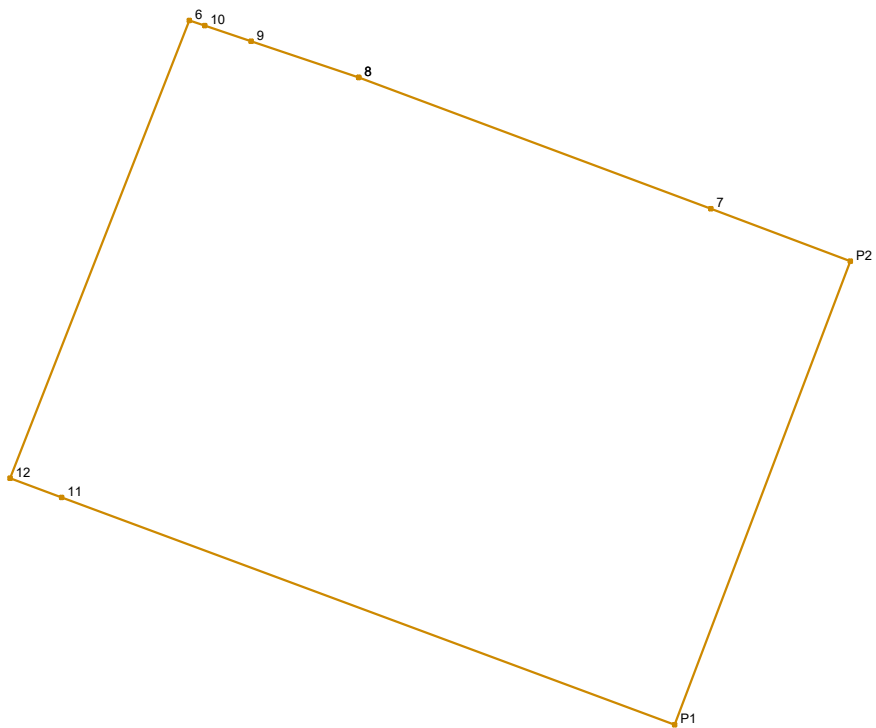

Νέα ιδιοκτησία εντός ΟΤ							
id1:1506		id2:02		Σημεία:9		Εμβαδό:363.22 m <sup>2</sup>	
Σημείο	X	Y	μήκος	Σημείο	X	Y	μήκος
8	499115.694	3928856.036	12.10	12	499104.465	3928843.128	15.84
7	499127.027	3928851.808		4.81	6	499110.238	
P2	499131.528	3928850.123	15.97		10	499110.734	3928857.709
P1	499125.865	3928835.190		21.06	9	499112.226	3928857.206
11	499106.118	3928842.515	1.76		8	499115.694	3928856.036

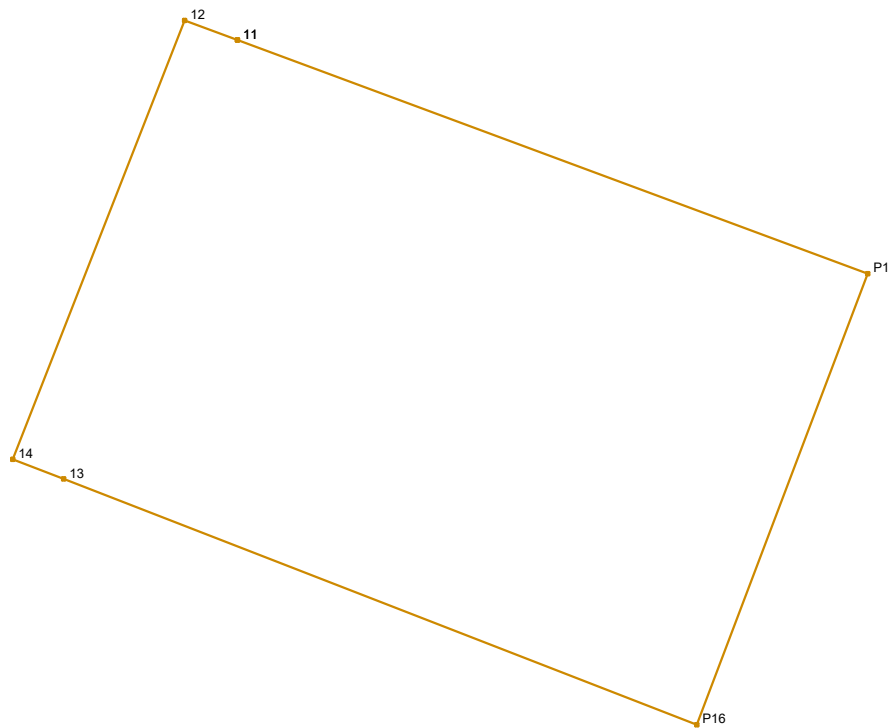

Νέα ιδιοκτησία εντός ΟΤ							
id1:1506		id2:03		Σημεία:6		Εμβαδό:342.00 m <sup>2</sup>	
Σημείο	X	Y	μήκος	Σημείο	X	Y	μήκος
11	499106.118	3928842.515	21.06	14	499099.085	3928829.382	14.76
P1	499125.865	3928835.190		15.11	12	499104.465	3928843.128
P16	499120.508	3928821.066	21.28	11	499106.118	3928842.515	
13	499100.674	3928828.765	1.70				

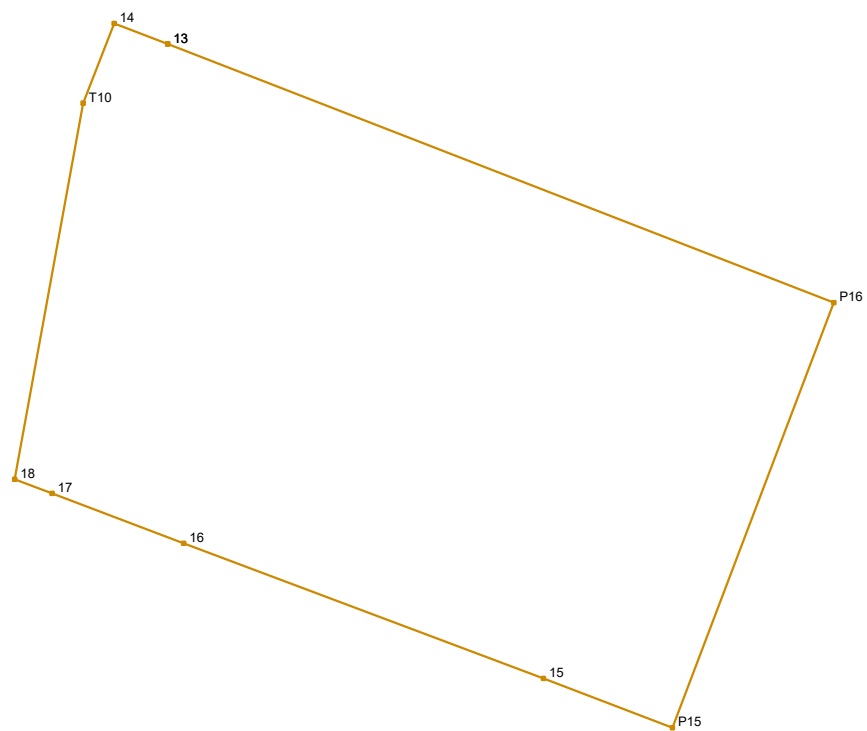

Νέα ιδιοκτησία εντός ΟΤ							
id1:1506		id2:04		Σημεία:9		Εμβαδό:302.10 m <sup>2</sup>	
Σημείο	X	Y	μήκος	Σημείο	X	Y	μήκος
13	499100.674	3928828.765	21.28	17	499097.234	3928815.383	1.19
P16	499120.508	3928821.066		18	499096.124	3928815.802	11.39
P15	499115.708	3928808.410	4.12	T10	499098.155	3928827.005	2.55
15	499111.865	3928809.882	11.45	14	499099.085	3928829.382	1.70
16	499101.149	3928813.903	4.19	13	499100.674	3928828.765	



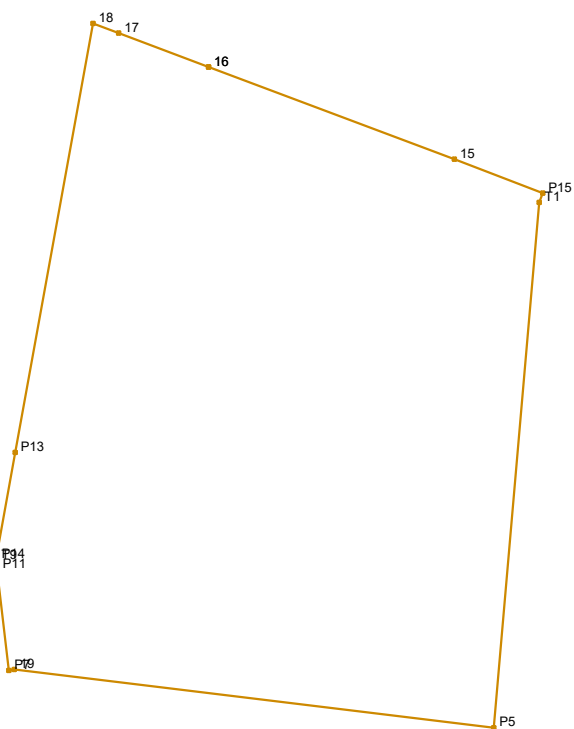

Νέα ιδιοκτησία εντός ΟΤ							
id1:1506		id2:05		Σημεία:13		Εμβαδό:553.03 m <sup>2</sup>	
Σημείο	X	Y	μήκος	Σημείο	X	Y	μήκος
16	499101.149	3928813.903	11.45	P11	499091.930	3928792.027	0.39
15	499111.865	3928809.882	4.12	T9	499091.884	3928792.418	0.06
P15	499115.708	3928808.410	0.43	P14	499091.894	3928792.473	4.72
T1	499115.555	3928808.007	22.97	P13	499092.736	3928797.117	18.99
P5	499113.573	3928785.121	21.04	18	499096.124	3928815.802	1.19
19	499092.682	3928787.661	0.24	17	499097.234	3928815.383	4.19
P7	499092.448	3928787.622	4.44	16	499101.149	3928813.903	

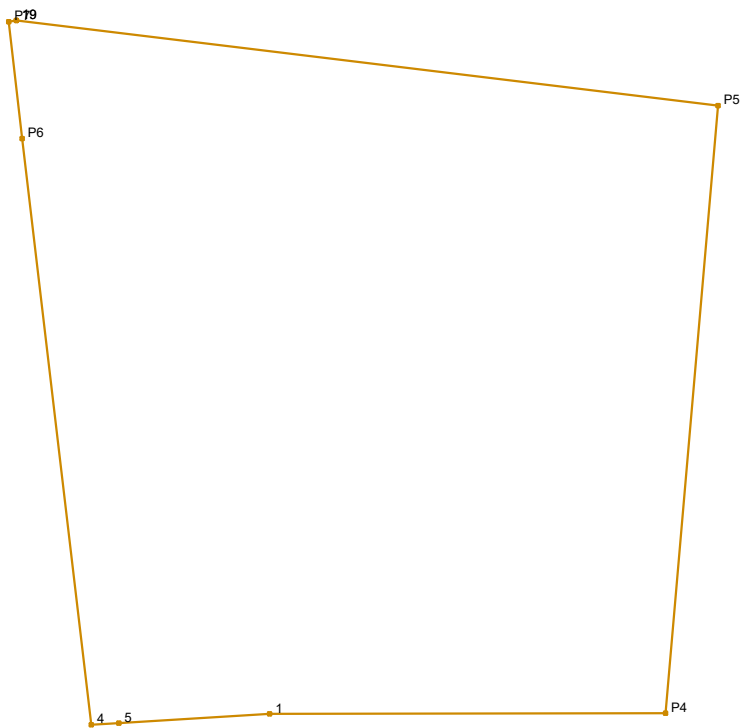

Νέα ιδιοκτησία εντός ΟΤ							
id1:1506		id2:06		Σημεία:8		Εμβαδό:371.21 m <sup>2</sup>	
Σημείο	X	Y	μήκος	Σημείο	X	Y	μήκος
19	499092.682	3928787.661	21.04	4	499094.909	3928766.689	17.57
P5	499113.573	3928785.121		18.16	P6	499092.858	3928784.138
P4	499112.006	3928767.031	11.79	P7	499092.448	3928787.622	0.24
1	499100.219	3928767.017	4.50	19	499092.682	3928787.661	
5	499095.728	3928766.739	0.82				

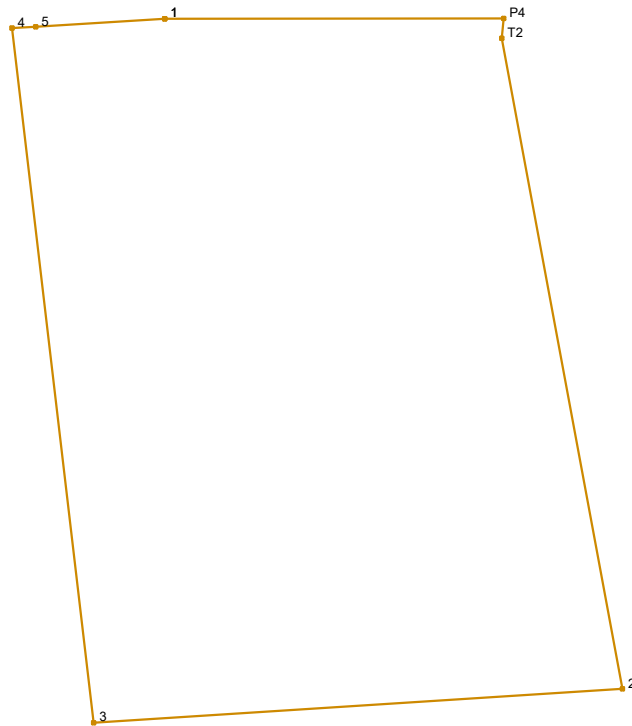

Νέα ιδιοκτησία εντός ΟΤ							
id1:1506		id2:07		Σημεία:7		Εμβαδό:423.66 m <sup>2</sup>	
Σημείο	X	Y	μήκος	Σημείο	X	Y	μήκος
1	499100.219	3928767.017	11.79	3	499097.749	3928742.532	24.32
P4	499112.006	3928767.031	0.70	4	499094.909	3928766.689	0.82
T2	499111.946	3928766.337	23.01	5	499095.728	3928766.739	4.50
2	499116.143	3928743.712	18.43	1	499100.219	3928767.017	

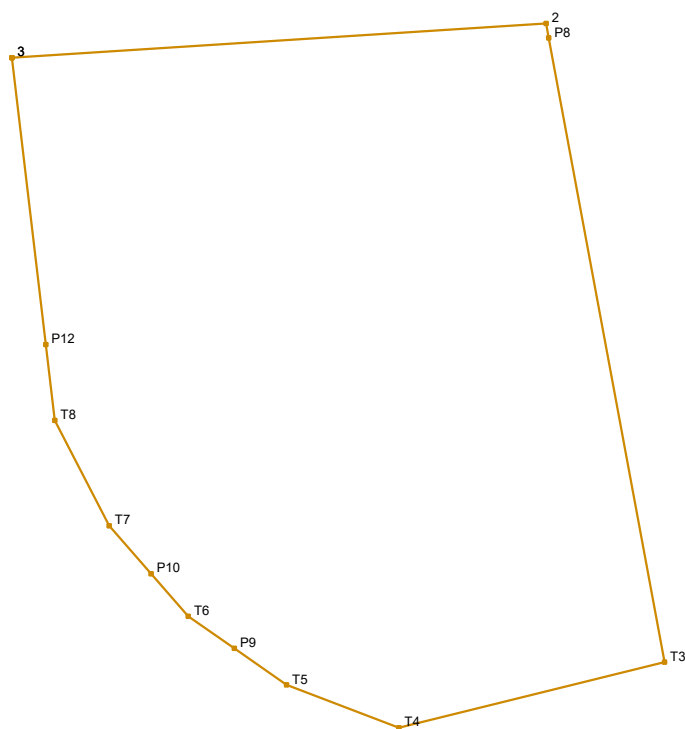

Νέα ιδιοκτησία εντός ΟΤ							
id1:1506		id2:08		Σημεία:12		Εμβαδό:411.43 m <sup>2</sup>	
Σημείο	X	Y	μήκος	Σημείο	X	Y	μήκος
3	499097.749	3928742.532	18.43	T6	499103.815	3928723.293	1.94
2	499116.143	3928743.712	0.51	P10	499102.537	3928724.752	2.19
P8	499116.236	3928743.209	21.86	T7	499101.092	3928726.403	4.09
T3	499120.224	3928721.712	9.43	T8	499099.217	3928730.040	2.63
T4	499111.068	3928719.452	4.13	P12	499098.911	3928732.648	9.95
T5	499107.207	3928720.929	2.20	3	499097.749	3928742.532	
P9	499105.403	3928722.186	1.94				

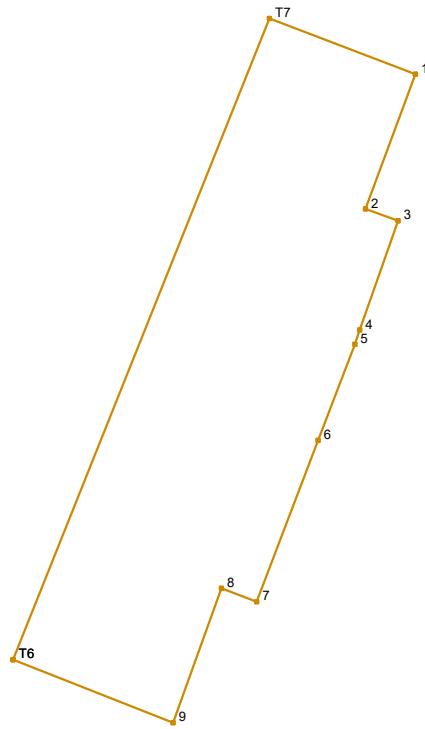

Νέα ιδιοκτησία εντός ΟΤ							
id1:1508		id2:01		Σημεία:11		Εμβαδό:1537.85 m <sup>2</sup>	
Σημείο	X	Y	μήκος	Σημείο	X	Y	μήκος
T6	499097.704	3928884.922	75.63	5	499135.104	3928919.453	11.26
T7	499125.764	3928955.149	17.11	6	499131.107	3928908.931	18.91
1	499141.747	3928949.043	15.74	7	499124.370	3928891.266	4.14
2	499136.277	3928934.288	3.80	8	499120.508	3928892.745	15.65
3	499139.837	3928932.967	12.66	9	499115.200	3928878.024	18.81
4	499135.657	3928921.013	1.66	T6	499097.704	3928884.922	

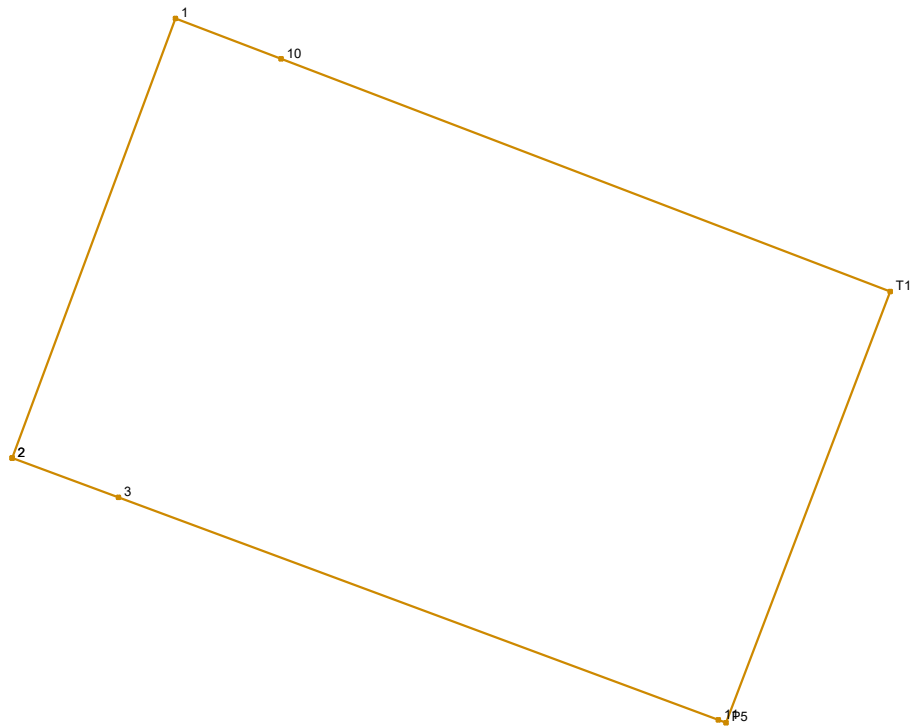

Νέα ιδιοκτησία εντός ΟΤ							
id1:1508		id2:02N		Σημεία:7		Εμβαδό:400.00 m <sup>2</sup>	
Σημείο	X	Y	μήκος	Σημείο	X	Y	μήκος
2	499136.277	3928934.288	15.74	P5	499160.232	3928925.400	0.27
1	499141.747	3928949.043		3.80	11	499159.974	3928925.496
10	499145.294	3928947.688	21.89	3	499139.837	3928932.967	3.80
T1	499165.745	3928939.876	15.49	2	499136.277	3928934.288	

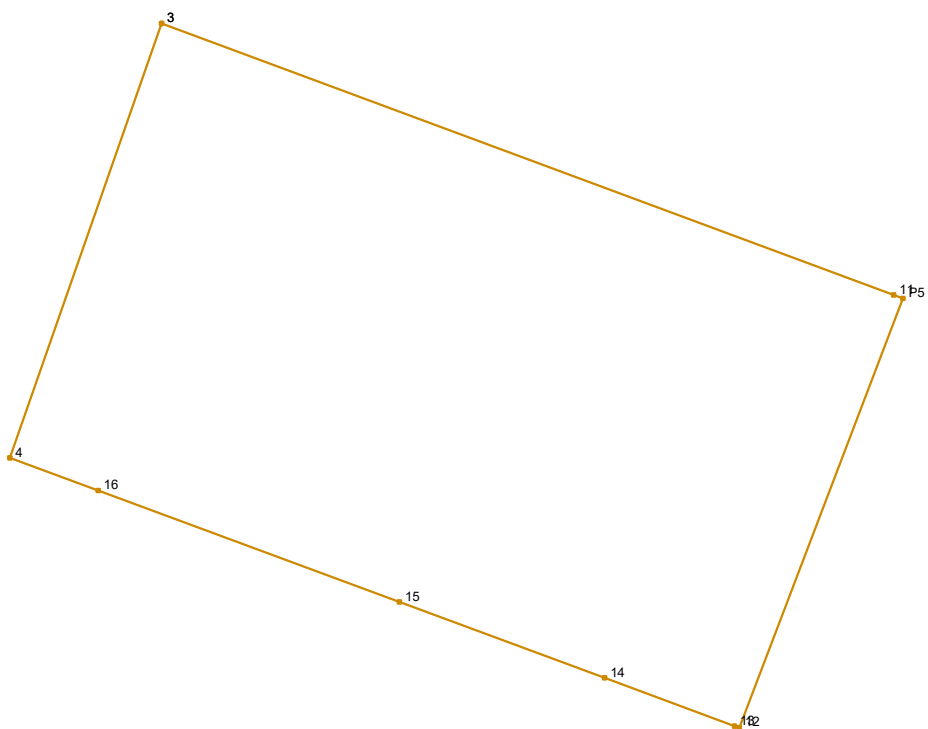

Νέα ιδιοκτησία εντός ΟΤ							
id1:1508		id2:03		Σημεία:9		Εμβαδό:273.00 m <sup>2</sup>	
Σημείο	X	Y	μήκος	Σημείο	X	Y	μήκος
3	499139.837	3928932.967	21.48	14	499152.025	3928914.958	6.02
11	499159.974	3928925.496		0.27	15	499146.378	
P5	499160.232	3928925.400	12.64	16	499138.095	3928920.111	2.60
12	499155.732	3928913.587	0.14	4	499135.657	3928921.013	12.66
13	499155.601	3928913.635	3.81	3	499139.837	3928932.967	

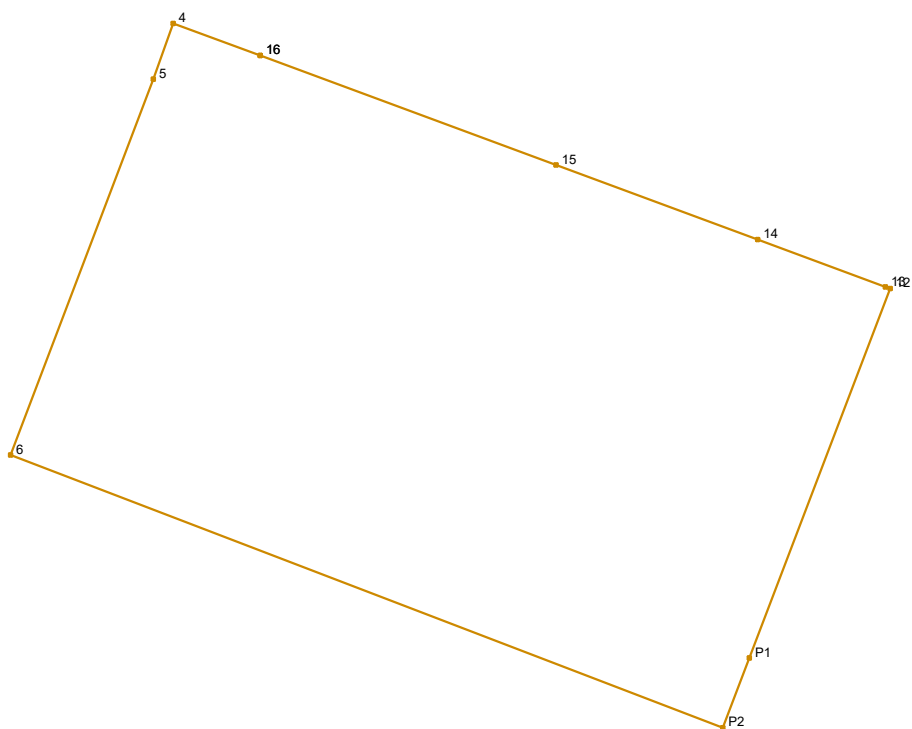

Νέα ιδιοκτησία εντός ΟΤ							
id1:1508		id2:04		Σημεία:10		Εμβαδό:278.42 m <sup>2</sup>	
Σημείο	X	Y	μήκος	Σημείο	X	Y	μήκος
16	499138.095	3928920.111	8.83	P2	499151.049	3928901.293	21.35
15	499146.378	3928917.047	6.02	6	499131.107	3928908.931	11.26
14	499152.025	3928914.958	3.81	5	499135.104	3928919.453	1.66
13	499155.601	3928913.635	0.14	4	499135.657	3928921.013	2.60
12	499155.732	3928913.587	11.06	16	499138.095	3928920.111	
P1	499151.794	3928903.247	2.09				



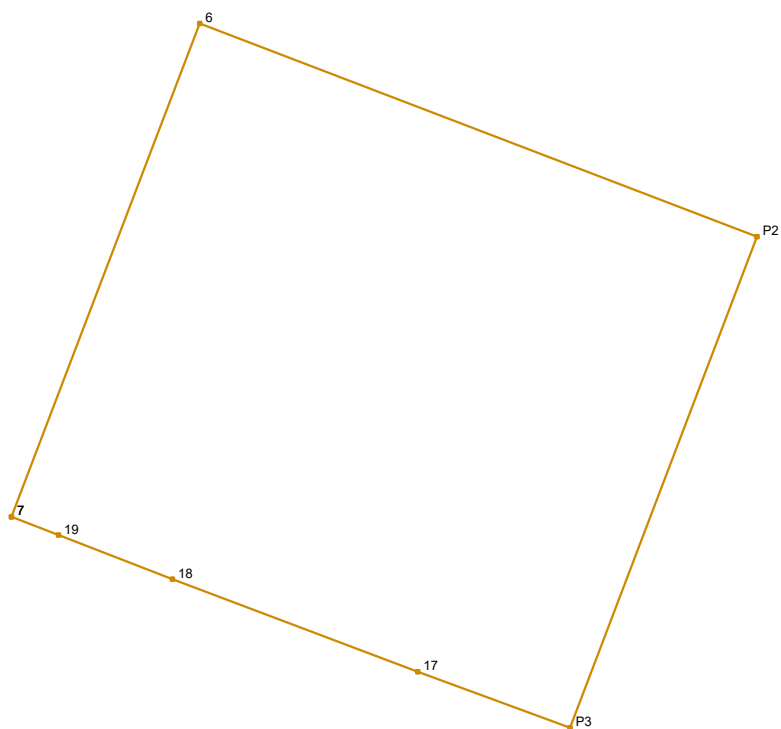

Νέα ιδιοκτησία εντός ΟΤ							
id1:1508		id2:05		Σημεία:7		Εμβαδό:403.52 m <sup>2</sup>	
Σημείο	X	Y	μήκος	Σημείο	X	Y	μήκος
7	499124.370	3928891.266	18.91	17	499138.901	3928885.725	9.38
6	499131.107	3928908.931	21.35	18	499130.125	3928889.035	4.37
P2	499151.049	3928901.293	18.80	19	499126.051	3928890.622	1.80
P3	499144.356	3928883.720	5.81	7	499124.370	3928891.266	

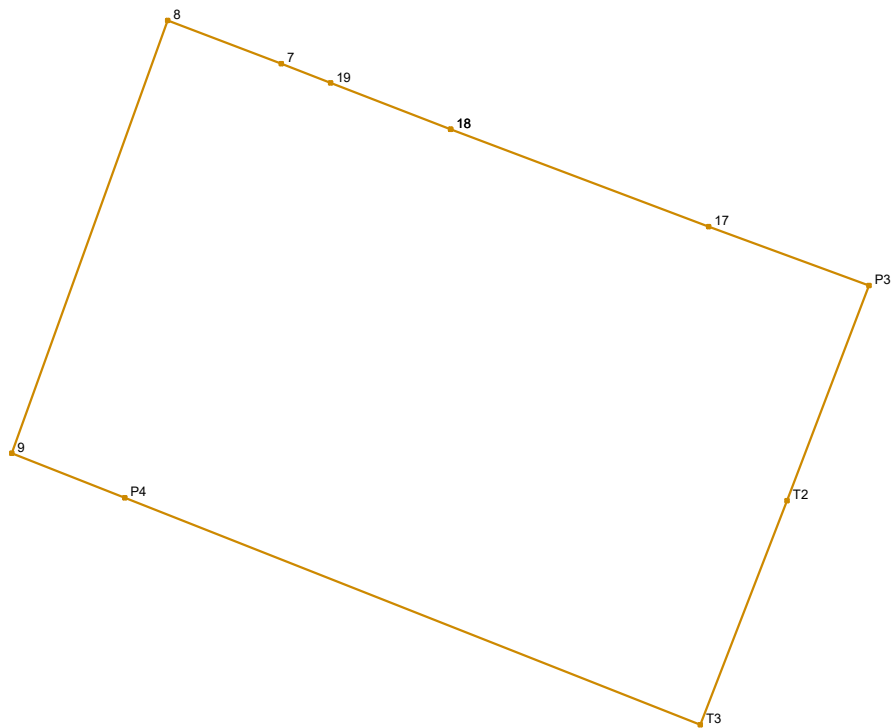

Νέα ιδιοκτησία εντός ΟΤ							
id1:1508		id2:06		Σημεία:10		Εμβαδό:400.00 m <sup>2</sup>	
Σημείο	X	Y	μήκος	Σημείο	X	Y	μήκος
18	499130.125	3928889.035	9.38	9	499115.200	3928878.024	15.65
17	499138.901	3928885.725	5.81	8	499120.508	3928892.745	4.14
P3	499144.356	3928883.720	7.83	7	499124.370	3928891.266	1.80
T2	499141.570	3928876.406	8.17	19	499126.051	3928890.622	4.37
T3	499138.627	3928868.788	21.04	18	499130.125	3928889.035	
P4	499119.049	3928876.507	4.14				

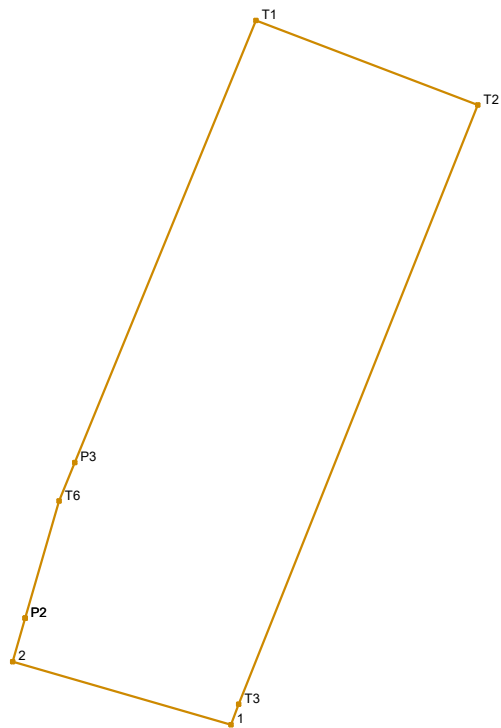

Νέα ιδιοκτησία εντός ΟΤ							
id1:1509		id2:01		Σημεία:8		Εμβαδό:2393.63 m <sup>2</sup>	
Σημείο	X	Y	μήκος	Σημείο	X	Y	μήκος
P2	499065.034	3928894.822	14.83	T3	499091.010	3928884.338	2.67
T6	499069.140	3928909.071	5.08	1	499090.096	3928881.834	27.68
P3	499071.068	3928913.775	58.19	2	499063.500	3928889.497	5.54
T1	499093.136	3928967.614	28.93	P2	499065.034	3928894.822	
T2	499120.158	3928957.291	78.56				

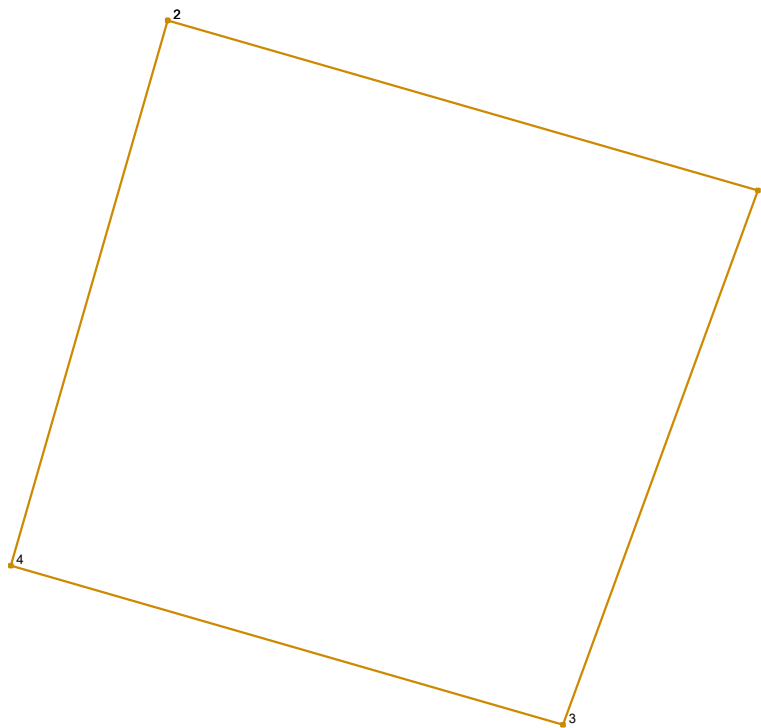

Νέα ιδιοκτησία εντός ΟΤ							
id1:1509		id2:02N		Σημεία:4		Εμβαδό:685.10 m <sup>2</sup>	
Σημείο	X	Y	μήκος	Σημείο	X	Y	μήκος
2	499063.500	3928889.497	27.68	4	499056.419	3928864.924	25.57
1	499090.096	3928881.834		25.63	2	499063.500	
3	499081.308	3928857.752	25.90				

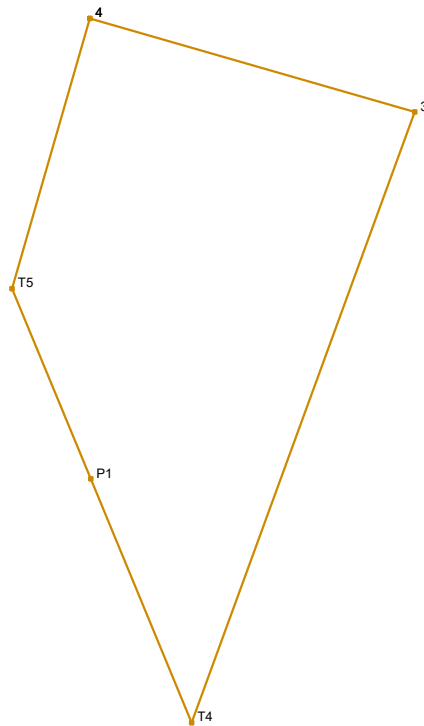

Νέα ιδιοκτησία εντός ΟΤ							
id1:1509		id2:03		Σημεία:5		Εμβαδό:885.76 m <sup>2</sup>	
Σημείο	X	Y	μήκος	Σημείο	X	Y	μήκος
4	499056.419	3928864.924	25.90	P1	499056.483	3928829.635	15.76
3	499081.308	3928857.752		49.82	T5	499050.447	3928844.199
T4	499064.227	3928810.949	20.23	4	499056.419	3928864.924	

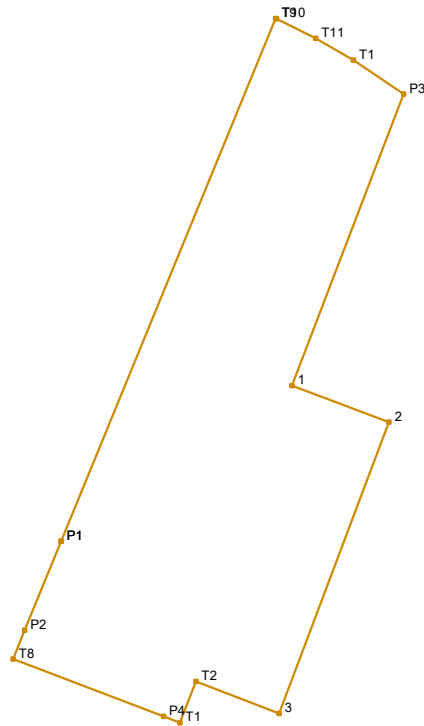

Νέα ιδιοκτησία εντός ΟΤ							
id1:1510		id2:01		Σημεία:14		Εμβαδό:2557.29 m <sup>2</sup>	
Σημείο	X	Y	μήκος	Σημείο	X	Y	μήκος
P1	499103.099	3928991.931	76.71	3	499132.695	3928968.559	12.12
T9	499132.188	3929062.908	0.15	T2	499121.370	3928972.885	6.00
T10	499132.329	3929062.848	5.93	T1	499119.229	3928967.280	2.38
T11	499137.619	3929060.173	5.93	P4	499117.004	3928968.130	21.90
T1	499142.763	3929057.226	8.24	T8	499096.547	3928975.945	4.20
P3	499149.583	3929052.610	42.38	P2	499098.139	3928979.829	13.08
1	499134.412	3929013.040	14.05	P1	499103.099	3928991.931	
2	499147.567	3929008.092	42.24				

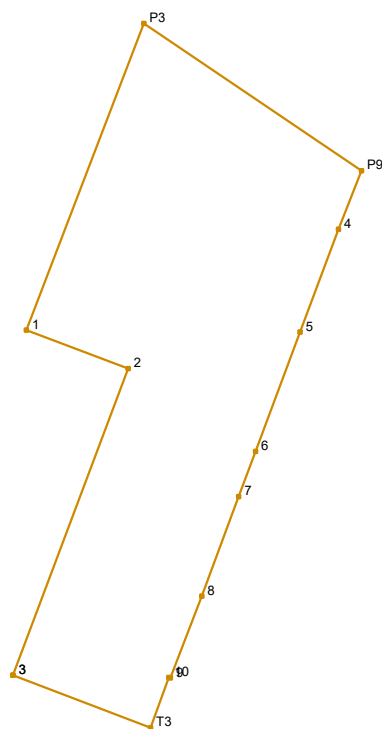

Νέα ιδιοκτησία εντός ΟΤ							
id1:1510		id2:02		Σημεία:13		Εμβαδό:2078.63 m <sup>2</sup>	
Σημείο	X	Y	μήκος	Σημείο	X	Y	μήκος
3	499132.695	3928968.559	42.24	6	499163.991	3928997.386	6.19
2	499147.567	3929008.092	14.05	7	499161.808	3928991.598	13.72
1	499134.412	3929013.040	42.38	8	499157.028	3928978.741	11.28
P3	499149.583	3929052.610	33.90	9	499153.011	3928968.198	0.21
P9	499177.656	3929033.615	8.14	10	499152.811	3928968.248	6.89
4	499174.684	3929026.041	14.15	T3	499150.457	3928961.773	19.01
5	499169.735	3929012.789	16.44	3	499132.695	3928968.559	

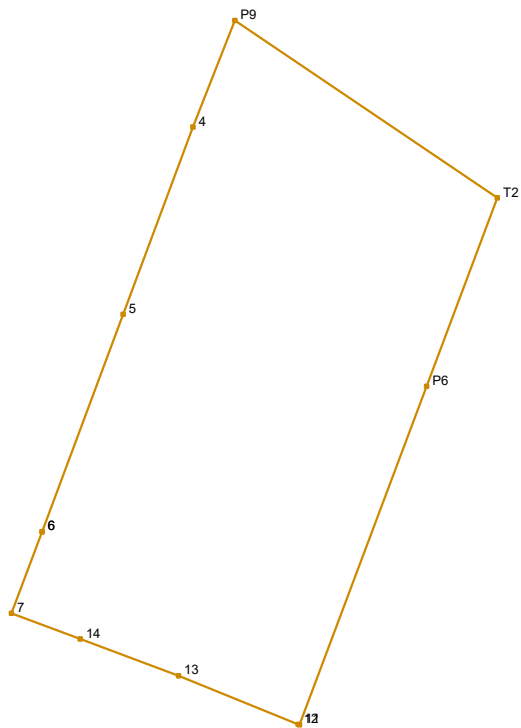

Νέα ιδιοκτησία εντός ΟΤ							
id1:1510		id2:03		Σημεία:11		Εμβαδό:927.31 m <sup>2</sup>	
Σημείο	X	Y	μήκος	Σημείο	X	Y	μήκος
6	499163.991	3928997.386	16.44	11	499182.225	3928983.696	0.08
5	499169.735	3929012.789	14.15	12	499182.149	3928983.727	9.17
4	499174.684	3929026.041	8.14	13	499173.645	3928987.166	7.43
P9	499177.656	3929033.615	22.44	14	499166.691	3928989.770	5.21
T2	499196.241	3929021.038	14.27	7	499161.808	3928991.598	6.19
P6	499191.227	3929007.679	25.62	6	499163.991	3928997.386	



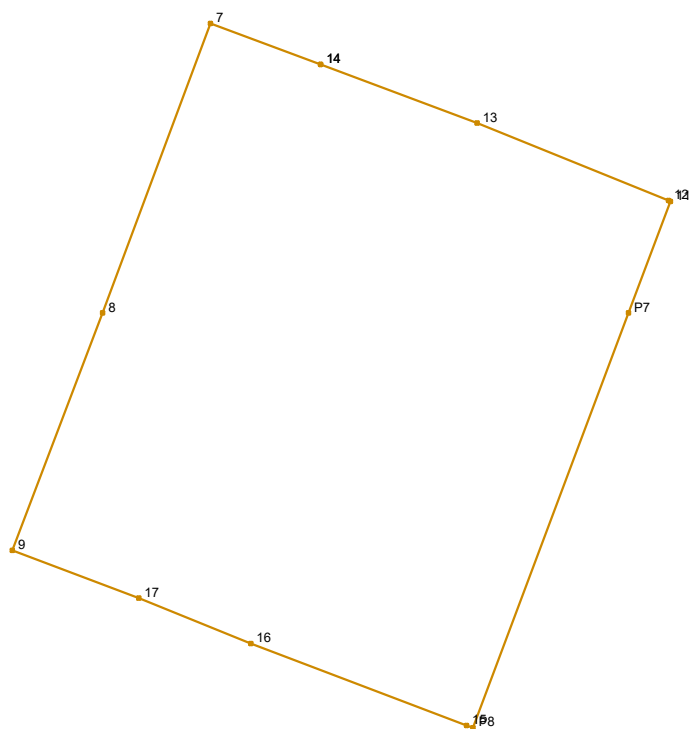

Νέα ιδιοκτησία εντός ΟΤ							
id1:1510		id2:04		Σημεία:12		Εμβαδό:548.11 m <sup>2</sup>	
Σημείο	X	Y	μήκος	Σημείο	X	Y	μήκος
14	499166.691	3928989.770	7.43	16	499163.594	3928964.065	5.36
13	499173.645	3928987.166		17	499158.624	3928966.079	
12	499182.149	3928983.727	9.17	9	499153.011	3928968.198	6.00
11	499182.225	3928983.696	0.08	8	499157.028	3928978.741	11.28
P7	499180.369	3928978.751	5.28	7	499161.808	3928991.598	13.72
P8	499173.455	3928960.330	19.68	14	499166.691	3928989.770	5.21
15	499173.174	3928960.436	0.30				
			10.24				

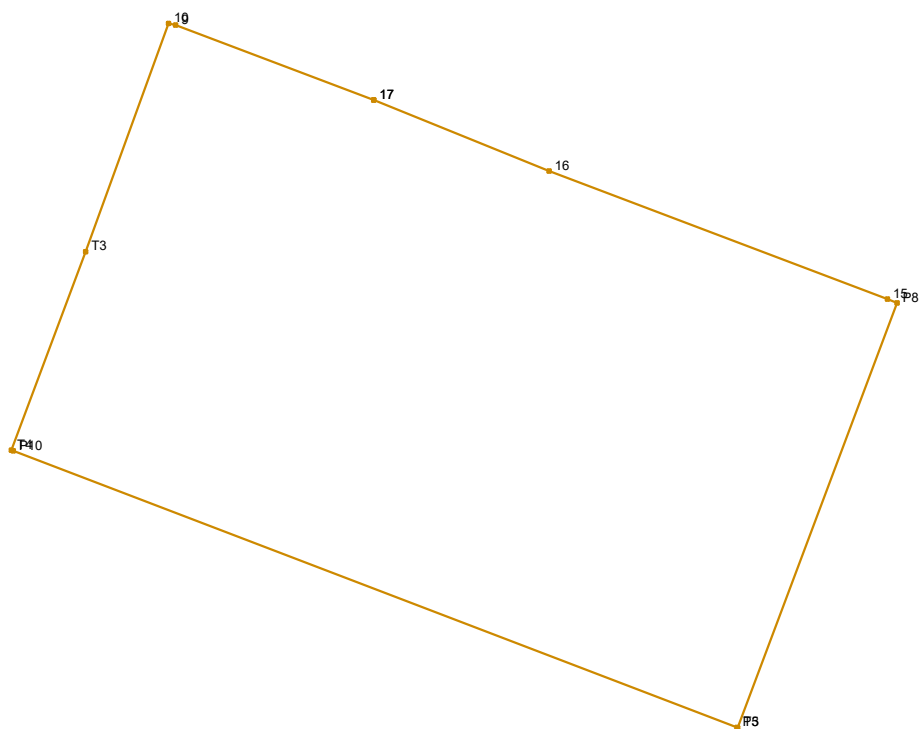

Νέα ιδιοκτησία εντός ΟΤ							
id1:1510		id2:05		Σημεία:11		Εμβαδό:283.99 m <sup>2</sup>	
Σημείο	X	Y	μήκος	Σημείο	X	Y	μήκος
17	499158.624	3928966.079	5.36	P10	499148.407	3928956.133	0.06
16	499163.594	3928964.065		T4	499148.355	3928956.153	6.00
15	499173.174	3928960.436	10.24	T3	499150.457	3928961.773	6.89
P8	499173.455	3928960.330	0.30	10	499152.811	3928968.248	0.21
T3	499168.936	3928948.291	12.86	9	499153.011	3928968.198	6.00
P5	499168.912	3928948.300	0.03	17	499158.624	3928966.079	
			21.95				